



NEED

Programmable Relays

User's Manual



© 2014 Relpol S. A.

CONTENTS

1. INTRODUCTION	7
2. GENERAL	8
2.1. Specifications	8
2.2. Description of NEED programmable relay front panel.....	8
2.3. System structure and order numbers.....	10
3. INSTALLATION	14
3.1. Installation order	15
3.2. Mechanical fixing	15
3.2.1. Attaching to the mounting rail (DIN 35mm).....	15
3.2.2. Bolt fixing	16
3.3. Terminals, cables	17
3.4. Connection of 230V AC discrete inputs	18
3.5. Connection of 220V DC discrete inputs	21
3.6. Connection of 24V (12V) DC discrete inputs.....	22
3.7. Analogue AC input connections.....	24
3.8. Analogue 220 DC input connections.....	26
3.9. Analogue 24V (12V) DC input connection.....	27
3.10. Output connection	30
3.11. AC power supply connection	31
3.12. 220 DC power supply connection	33
3.13. 24V (12V) DC power supply connection	34
4. RELAY RESOURCES	35
4.1. NEED Programmable Relay system.....	35
4.2. Program cycle	35
4.3. NEED Programmable Relay resources.....	37
4.4. Digital inputs.....	40
4.4.1. Normally open digital inputs.....	40
4.4.2. Normally closed digital inputs.....	40
4.5. Digital outputs.....	40
4.5.1. Normal digital outputs.....	41
4.5.2. Digital pulse outputs.....	41
4.5.3. Digital resetting outputs.....	42
4.5.4. Digital setting outputs.....	42
4.5.5. Normal digital outputs used for further control.....	42
4.5.6. Inverted digital outputs used for further control.....	43
4.6. Markers	43
4.6.1 Markers.....	43
4.6.2. MDIR Marker	44
4.6.3. Text Marker.....	46
4.7. Timers	47
4.7.1. Timer „Delayed activation” (ON-DELAYED).....	48
4.7.2. Timer “Delayed deactivation” (OFF-DELAYED)	49
4.7.3. Timer “Single pulse”	49
4.7.4. Timer “Pulses” (FLASHING)	50
4.8. Counters.....	51
4.9. Clocks	53
4.9.1. Clock operation.....	54
4.9.2. Remarks concerning Clock configuration	64
4.10. Real time clock,	67
4.11. Comparator – analogue inputs.....	68

4.12. Potentiometer	73
4.13. Remanent values of the programmable relay	74
4.13.1. Remarks on remanent values	75
4.14. Keyboard buttons	77
4.14.1. Buttons as normally open digital inputs	78
4.14.2. Buttons as normally closed digital inputs.....	78
5. PROGRAMMING LANGUAGES.....	79
5.1. Text language (STL) programming	79
5.1.1. STL program structure	79
5.1.1.1. Symbolic names.....	82
5.1.2. Description of STL instructions.....	83
5.1.2.1. <i>AND</i> instruction	83
5.1.2.2. <i>AND</i> parenthesis instruction	83
5.1.2.3. <i>AND NOT</i> instruction.....	86
5.1.2.4. <i>AND NOT</i> parenthesis instruction.....	86
5.1.2.5. <i>OR</i> instruction	87
5.1.2.6. <i>OR</i> parenthesis instruction	88
5.1.2.7. <i>OR NOT</i> instruction	89
5.1.2.8. <i>OR NOT</i> parenthesis instruction.....	90
5.1.2.9. <i>XOR</i> instruction	91
5.1.2.10. <i>XOR</i> parenthesis instruction	91
5.1.2.11. <i>XOR NOT</i> instruction.....	92
5.1.2.12. <i>XOR NOT</i> parenthesis instruction	93
5.1.2.13. <i>S</i> setting instruction	94
5.1.2.14. <i>R</i> resetting instruction.....	94
5.1.2.15. = assigning instruction.....	94
5.1.2.16. <i>FP</i> pulse relay instruction	95
5.1.2.17. Timer instructions.....	96
5.1.2.18. Counter instructions	101
5.1.2.19. Clock instructions	106
5.1.2.20. Analogue inputs	107
5.1.2.21. Load statement (LOAD).....	108
5.1.2.21.1. 'L' statement for Timers.....	108
5.1.2.21.1.1. Constant time values for Timers.....	108
5.1.2.21.1.2. Time values for Timers based on the Potentiometer setting	108
5.1.2.21.1.3. Time values for <i>Timers</i> based on the voltage values on analog	
voltage inputs.....	109
5.1.2.21.1.4. Time values for Timers based on the current values on current analog	
inputs.....	110
5.1.2.21.2. 'L' statement for Counters.....	111
5.1.2.21.2.1. Constant threshold values for counters.....	111
5.1.2.21.2.2. Threshold values for counters, defined according to the Potentiometer	
setting	111
5.1.2.21.2.3. Threshold values for <i>Counters</i> based on the voltage values on analog	
voltage	112
inputs.....	112
5.1.2.21.2.4. Threshold values for <i>Counters</i> based on the voltage values on.....	113
current analog inputs.....	113
5.1.2.22. "Always setting" instruction SET	116
5.1.2.23. "Always clearing" instruction CLR.....	117
5.2. Programming in LAD graphic language	118
5.2.1. Symbols in LAD.	118
5.2.2. Inputs.....	119
5.2.3. Outputs.....	119
5.2.4. LAD program structure.....	120

5.2.5. LAD network structure.....	120
5.2.6. Description of elements used.....	121
5.2.7. Configuration.....	123
5.2.7.1. Configuration of inputs	123
5.2.7.2. Configuration of outputs	124
5.2.7.3. Configuration of Markers	124
5.2.7.4. Configuration of Timers	125
5.2.7.5. Configuration of Counters.....	126
5.2.7.6. Sample configurations.....	127
5.2.8. Element location rules	128
5.2.9. Connection types.....	128
5.2.9.1. Mapping the input to the output.....	128
5.2.9.2. Mapping the negated input to the output.....	128
5.2.9.3. Series connection.....	129
5.2.9.4. Parallel connections	129
5.2.9.5. Series-parallel connection.....	130
5.2.10. Symbolic names.....	131
5.2.11. LAD program.....	132
6. INSTALLATION AND SOFTWARE DESCRIPTION	133
6.1. Hardware requirements	133
6.2. Software installation	133
6.3. Uninstalling.....	133
6.4. Connecting the PC to the programmable relay	133
6.5. Quick start – creating the application.....	134
6.6. Working with PC Need.....	140
6.6.1. Main program window description.....	140
6.6.2. Menu bar	141
6.6.3. Toolbar	143
6.6.4. Keyboard shortcuts.....	144
6.7. STL program editor.....	146
6.7.1. STL editor	146
6.7.2. STL Compilation	147
6.7.3. Configuration of STL editor	148
6.8. LAD program editor	149
6.8.1. New program	149
6.8.2. Saving a program.....	150
6.8.3. Opening an existing program	151
6.8.4. Program edition	151
6.8.5. Edition of an object	155
6.8.6. Comments	158
6.8.7. Configuration of LAD editor.....	160
6.9. Settings	161
6.9.1. Types of settings.....	161
6.9.2. Timer settings	163
6.9.3. Clock settings	164
6.9.4. Counter settings.....	164
6.9.5. Comparator settings.....	165
6.9.6. Remanence	165
6.9.7. Input delays	166
6.9.8. Text Markers.....	167
6.10. Preview of variables	169
6.11. LAD ladder view	171
6.12. Password.....	172
6.12.1. Password entering	172
6.12.2. Changing the password	173

6.13. Real-time clock (RTC)	174
6.14. Source code	175
6.15. Document conversion	176
7. START-UP	178
7.1. Switching on	178
7.1.1. Preliminary operations for the AC version.	178
7.1.2. Preliminary operations for the DC version.	178
7.1.3. Turning the power on.	178
8. INFORMATION ON HARDWARE	179
8.1. Relay power supply	179
8.1.1. Relay 115/230 V AC power supply	179
8.1.2. Relay 220 V DC power supply	179
8.1.3. Relay 24 (12) V DC power supply	179
8.2. Inputs	180
8.2.1. 230 V AC inputs	180
8.2.2. 220 V DC inputs	182
8.2.3. 24 (12) V DC inputs	183
8.3. Outputs	183
8.4. Input delay	185
8.4.1. Input delays for NEED-230AC-... relay	185
8.4.2. Input delays for NEED-24DC-... , NEED-12DC relays	187
8.5. Output delay	188
9. EXTERNAL MEMORY	189
9.1. Memory card	189
9.2. Storage organization	190
9.3. Memory programming	190
9.3.1. Writing a program	190
9.3.2. Writing settings	191
9.3.3. EEPROM memory status	191
9.3.4. Reading the settings	192
9.4. Operation of memory card with NEED relay	192
10. LCD DISPLAY AND KEYBOARD	194
10.1. Overview	194
10.2. Main menu	196
10.3. Configuration menu	197
10.3.1. Settings Menu	197
10.3.1.1. Timers menu	198
10.3.1.2. Calendar menu	203
10.3.1.3. Counters menu	206
10.3.1.4. Comparators menu	208
10.3.1.5. Markers menu	210
10.3.1.6. Inputs menu	212
10.3.1.7. Outputs menu	213
10.3.1.8. Buttons menu	215
10.3.1.9. Fast Counter menu	215
10.3.2. System menu	218
10.3.2.1. Backlight	219
10.3.2.2. Language	219
10.3.3. Password Menu	220
10.3.3.1. Password enter	221
10.3.3.2. Password change	222
10.3.4. Version Menu	224
10.4. Time Menu	226
10.5. Date Menu	230
10.6. Alerts menu	233

10.7. External Memory menu.....	235
11. SAMPLE APPLICATIONS	237
11.1. Part height assessment	237
11.2. Automatic door	242
11.3. School bells	250
11.4. Fault detection	257
10.5. Control of the travel of cars in the bend of the belt conveyor.....	261
10.6. Lighting and ventilation controller	265
10.7. Load control.....	272
10.8. Three-phase motor control and protection	275
12. TECHNICAL SPECIFICATIONS.....	281
13. GLOSSARY.....	294
14. INDEX	294

1. INTRODUCTION

NEED is a programmable relay which may replace even complex relay or contactor connections. The device is freely programmable i.e. the program present in the controller's memory can be modified at any time without having to change the peripheral systems of the entire environment, which was actually impossible using conventional relay control. Extensive capabilities and excellent parameters combined with functionality of the programmable relay enable the shortening of design time and the reduction of costs of applications implemented

2. GENERAL

2.1. Specifications

- 6 or 13 digital inputs,
- 2 or 3 digital-analog inputs:
 - NEED-230AC-x1-... : 0–255V AC,
 - NEED-220DC-x1-... : 0–255V DC,
 - NEED-24DC-x1-..., NEED-12DC-x1-... :
 - voltage range: 0–25,5V DC (in 0.10V steps) or 0 – 12.75V (in 0.05V steps),
 - current range: 0–51mA (0.2mA steps) or 0 – 25.5mA (in 0.1mA steps),
- 4 or 8 relay outputs (230V AC/10A),
- 4 or 8 transistor output (24DC/0,5A)
- high-contrast backlit display (4 lines of 12 characters) with a keyboard,
- LCD display and keyboard module,
- four user-programmable keys
- Potentiometer for setting the analog values,
- Real time clock,
- Automatic change of summer/winter time in different time zones,
- Operation mode indicator
- RUN/STOP operation mode switch
- I/O status indications
- Programmability of LAD and STL,
- PC software,
- External memory module,
- Fast counter/frequency measuring device (up to 20kHz)
- Detection of correct direction of connection of the L1, L2, L3 phases
- Measurement of asymmetry of the L1, L2, L3 phases.

2.2. Description of NEED programmable relay front panel.

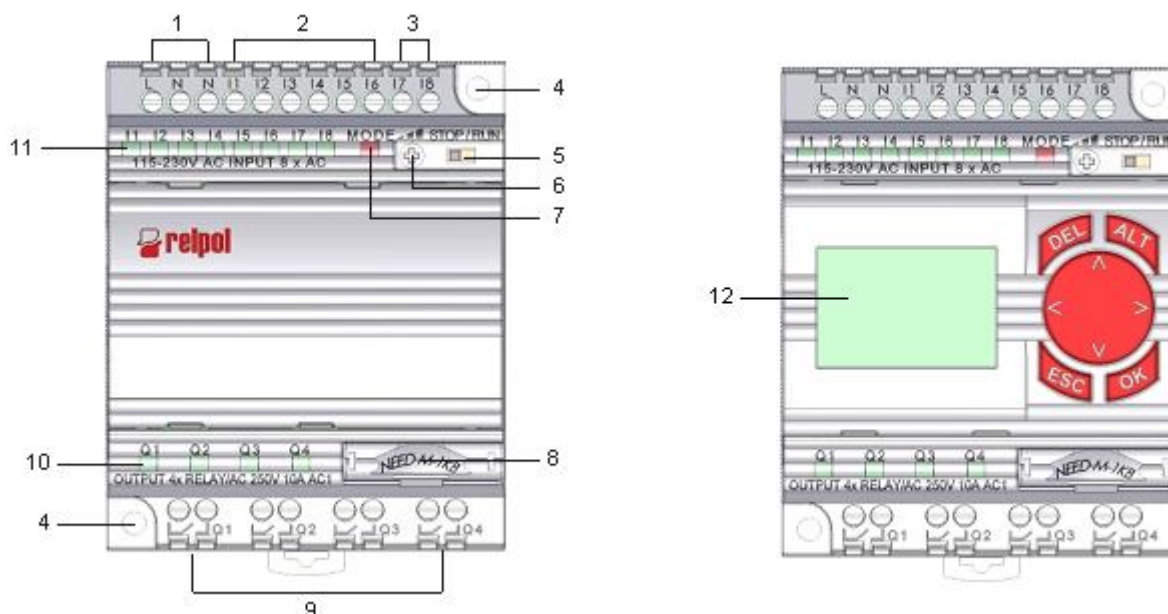

Fig. 2.2.1. Description of NEED-...-08-4x-... programmable relay front panel.

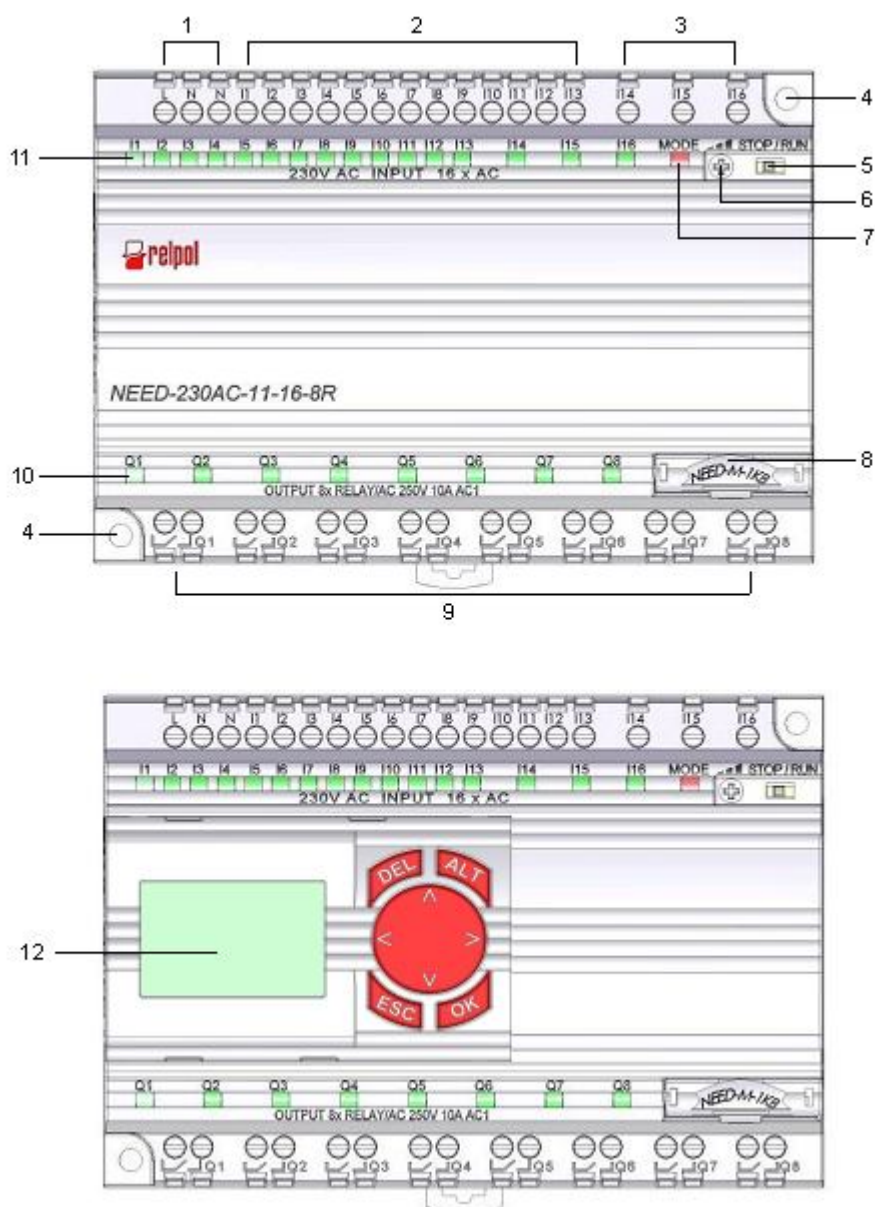
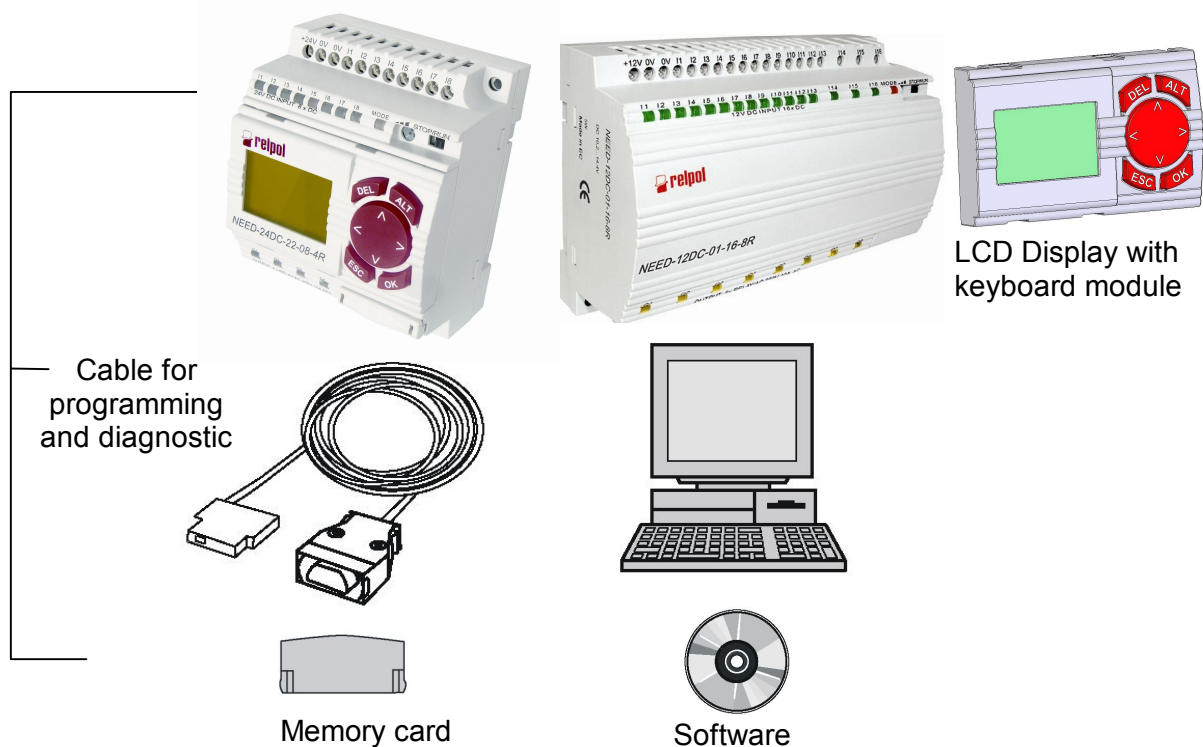

Fig. 2.2.2. Description of NEED-...-16-8x-.. programmable relay front panel.

Designation	Description
1	Screw terminal for power supply
2	Screw terminals for digital inputs
3	Screw terminals for digital and analogue inputs
4	Mounting holes
5	Operating mode switch (RUN-STOP)
6	Potentiometer for setting analogue values
7	Relay status LED indicator
8	Terminal for programming and additional program memory module
9	Screw terminals for outputs Q1 – Q4
10	LED indicators of output states
11	LED indicators of input states
12	LCD display and keyboard module

2.3. System structure and order numbers

NEED Programmable Relay



Type designation

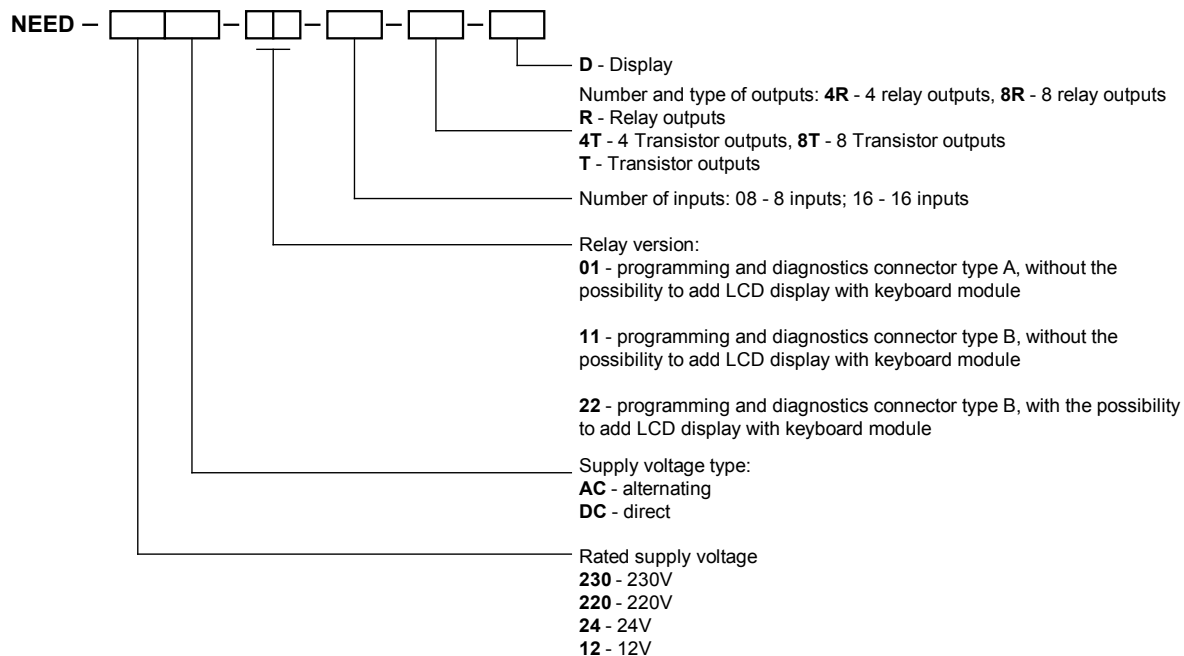



The NEED-..x1-.. relays doesn't work with LCD display with a keyboard.
The NEED-..22-16-8-D relays have a built-in LCD display with a keyboard, while the NEED-..22-08-4 relay can be connected to an external LCD panel with a keyboard.

Table 2.3.1. Possibility to add LCD display with keyboard module to NEED relay.

Type	Built-in keyboard and LCD display	Attached keyboard and LCD display
NEED-...x1-..	–	–
NEED-..-22-08-4x-..	–	Yes
NEED-..-22-16-8x-D	Yes	–

Example 1:

NEED – 230AC – 01 – 08 – 4R

The NEED programmable relay– rated supply voltage 230V AC – version 01, programming port type A – 8 inputs – 4 relay outputs – without the possibility to add any extensions, an LCD display, inputs without galvanic separation.

Example 2:

NEED-24DC-22-08-4T

NEED programmable relay – rated supply voltage of 24V DC – version 22 with interface for B-type programming – 8 inputs – 4 transistors outputs with the possibility of connecting an LCD display

Example 3:

NEED-24DC-22-16-8R-D

NEED programmable relay – rated supply voltage of 24V DC – version 22 with interface for B-type programming – 16 inputs – 8 relay outputs with a built-in LCD display

Table 2.3.3 lists all types of the NEED programmable relays with information on the support for LCD display module, cable for programming and memory.



The programmable relay requires the use of a cable for programming and software diagnostic.

Table 2.3.2. Memory ordering codes.

Name	Designation
NEED Programmable Relay	See the type designation
Programming and diagnostics cable RS232 with A type connector	NEED – PC – 15A
Programming and diagnostics cable RS232 with B type connector	NEED – PC – 15B
Programming and diagnostics cable USB with B type connector	NEED – PC – 15C
Memory card with A type connector, 1KB for NEED-..-01-..	NEED – M – 1K
Memory card with B type connector, 1KB for NEED-..-11-..	NEED – M – 1KB
Memory card with B type connector, 4KB for NEED-..-22-..	NEED – M – 4KB
Software	NEED – PC Need
User's guide	The NEED Programmable Relay – User's Guide



NEED with a type A programming and diagnostics connector can be programmed only by means of the type A programming cable. The memory card must also be equipped with a type A connector. The same applies to the NEED relay with B type connector.

Example 4:

When purchasing the *NEED-230AC-01-08-4R* relay, you should also order:
 NEED-PC-15A – cable for programming and diagnostics with A-type interface, and
 NEED-M-1K – memory card with A-type interface.

Example 5:

When purchasing the *NEED-230AC-22-08-4R-D* relay, you should also order:
 NEED-PC-15B or NEED-PC-15C – cable for programming and diagnostics B-type interface,
 and NEED-M-4KB.

Table 2.3.3. Selection table.

Type	LCD module	Cable	Memory
NEED-230AC-01-08-4R	–	NEED-PC-15A	NEED – M – 1K
NEED-12DC-01-08-4R	–	NEED-PC-15A	NEED – M – 1K
NEED-24DC-01-08-4R	–	NEED-PC-15A	NEED – M – 1K
NEED-230AC-11-08-4R	–	NEED-PC-15B NEED-PC-15C	NEED – M – 1KB
NEED-220DC-11-08-4R	–	NEED-PC-15B NEED-PC-15C	NEED – M – 1KB
NEED-12DC-11-08-4R	–	NEED-PC-15B NEED-PC-15C	NEED – M – 1KB
NEED-24DC-11-08-4R NEED-24DC-11-08-4T	–	NEED-PC-15B NEED-PC-15C	NEED – M – 1KB
NEED-230AC-11-16-8R	–	NEED-PC-15B NEED-PC-15C	NEED – M – 1KB
NEED-12DC-11-16-8R	–	NEED-PC-15B NEED-PC-15C	NEED – M – 1KB
NEED-24DC-11-16-8R NEED-24DC-11-16-8T	–	NEED-PC-15B NEED-PC-15C	NEED – M – 1KB
NEED-230AC-22-08-4R-D	NEED – LCD – A	NEED-PC-15B NEED-PC-15C	NEED – M – 4KB
NEED-12DC-22-08-4R-D	NEED – LCD – A	NEED-PC-15B NEED-PC-15C	NEED – M – 4KB
NEED-24DC-22-08-4R-D NEED-24DC-22-08-4T-D	NEED – LCD – A	NEED-PC-15B NEED-PC-15C	NEED – M – 4KB
NEED-230AC-22-16-8R-D	in-built	NEED-PC-15B NEED-PC-15C	NEED – M – 4KB
NEED-12DC-22-16-8R-D	in-built	NEED-PC-15B NEED-PC-15C	NEED – M – 4KB
NEED-24DC-22-16-8R-D NEED-24DC-22-16-8T-D	in-built	NEED-PC-15B NEED-PC-15C	NEED – M – 4KB



Fig. 2.3.2. Programming and diagnostics cable RS232 and memory with A type connector.

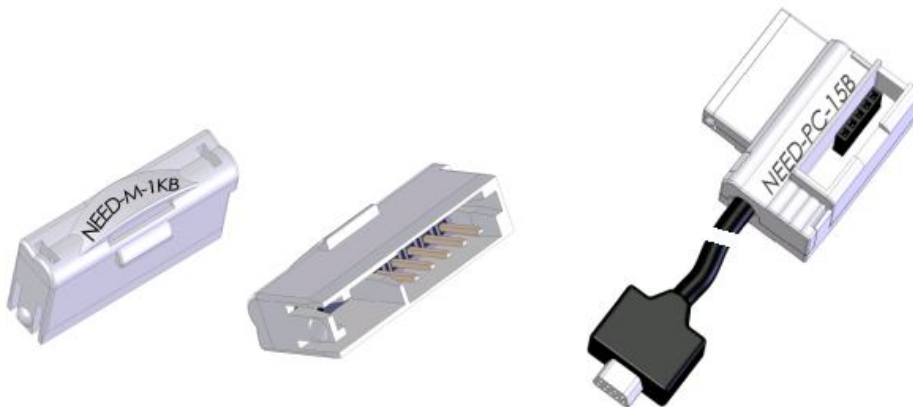

Fig. 2.3.3. Programming and diagnostics cable RS232 and memory with B type connector.



Fig. 2.3.4. Programming and diagnostics cable USB with B type connector.

3. INSTALLATION

Symbols used

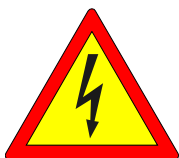

Electric shock hazard!



Do not perform any work on a powered unit!



Warning!

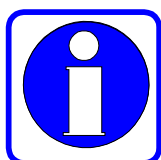

Information and hints.

Please read the following before installing the programmable relays!!!



Dangerous voltages capable of causing death are present in the programmable relay and at its connections.

- Turn off the device/system where the programmable relay is to be installed.
- Protect the device/system from inadvertent activation.
- Make sure that no voltage is present in the device/system.
- Set the switch of the programmable relay to STOP.
- Make all necessary measurements and checks in order to prevent unintended activation of the programmable relay.
- Remember to eliminate electrostatic charge before touching the apparatus.
- Connect short-circuit and preventive protections.
- Observe the rules and recommendations indicated in the User's Manual.
- Installation of the programmable relay should be carried out by a person acquainted with the principles of electric installation.
- Remember that, once installed, the devices must be protected against inadvertent activation.
- All connections of the programmable relay must be compliant with relevant safety standards.
- The parameters of the power supply network should not exceed the tolerance limits indicated in the relay's technical specifications.
- Should the relay be used in systems where emergency stop is required, behaviour of the system during activation and release of the emergency stop must be defined in order to avoid unforeseen occurrences e.g. uncontrolled activation of the automation system.
- Define proper reaction of the system to switching the power off and then back on.

Safety conditions

- In order to ensure safe operation and reliable functioning of the unit, installation of the programmable relay should be performed by a person familiar with electric installation rules.
- Safety standards pertaining to work with electrical equipment as well as health and occupational safety rules must be duly observed during installation.
- Follow the programmable relay installation conditions.

3.1. Installation order

1. Preparation and protection of the installation place.
2. Mechanical fixing.
3. Connection of cables
 - connection of inputs.
 - connection of outputs.
 - connection of power supply.

3.1.1. Preparation and safeguarding of the installation place



- Turn off the unit/system where the programmable relay is to be installed.
- Be aware of the electric shock hazard.
- Protect the unit/installation from inadvertent activation.
- Make sure that no voltage is present in the unit/system.
- Where it is not possible to fully cut off the current from the installation area, points that pose a contact hazard must be additionally protected; exercise utmost care!



- Check the condition of cables.

3.2. Mechanical fixing

3.2.1. Attaching to the mounting rail (DIN 35mm)

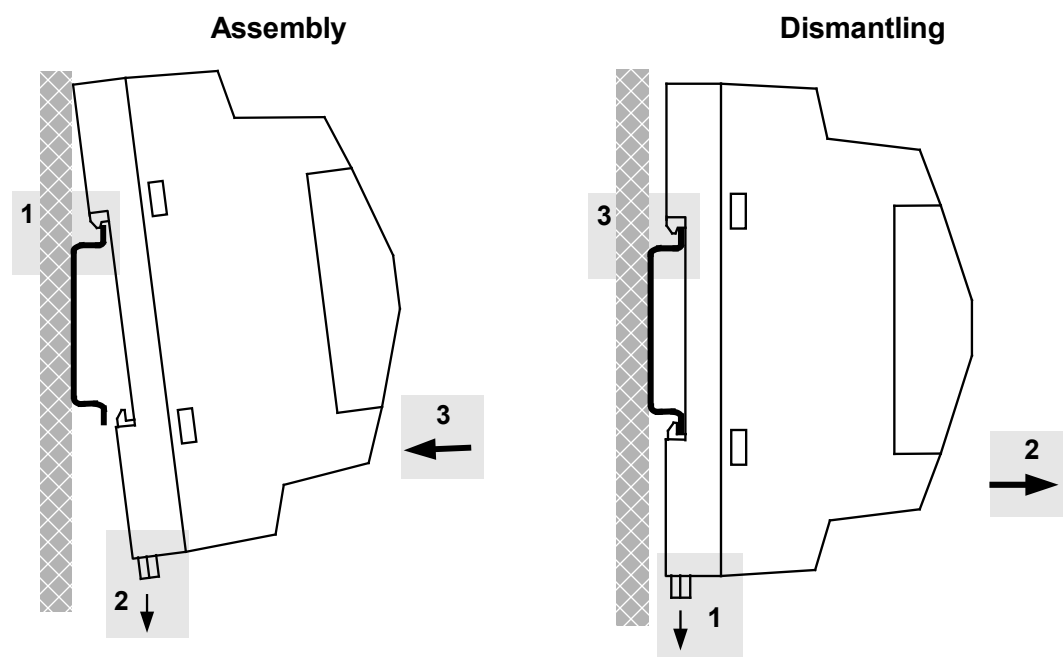

Fig. 3.2.1. Attachment to the mounting rail.

Assembly (fig. 3.2.1.)

1. Attach the module to the top part of the mounting bar.
2. Pull the bottom catch down.
3. With the bottom catch retracted push the module forward and release the retracted catch.
4. Ensure that the relay module is mounted securely.

Dismantling (fig. 3.2.1.)

1. Pull the bottom catch down.
2. With the bottom catch retracted draw the module aside from the bar.
3. Lift the module and remove it from the bottom catches.

3.2.2. Bolt fixing

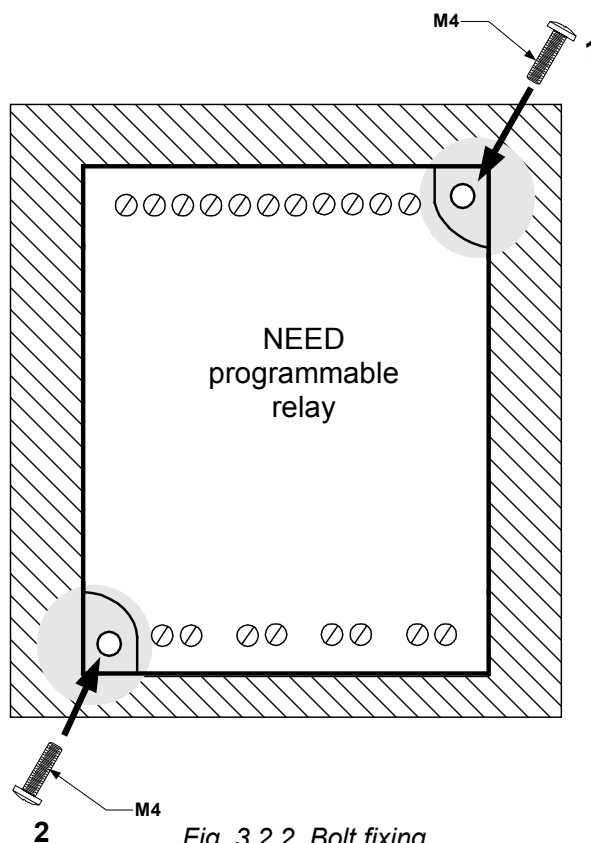

Fig. 3.2.2. Bolt fixing.

Two bolt (or tapping screw) fixing.

Diameters of bolt fixing holes: 5.5 mm.

Note: No additional adapters are necessary to perform the fixing, use the fixing holes provided.

Clearances:

It is recommended to keep a distance of 3 cm between the edges of the input and those of the output connectors of the programmable relay and other installation parts (mounting channels, other apparatuses, mounting cabinet wall etc.). This will enable easy cable laying and ensure efficient cooling of the module. Clearances to be observed when fixing the module are shown in Fig. 3.2.3.

Side walls may contact other apparatuses, housing parts etc.

The above notes refer to both horizontal and vertical fixing; the distance from the connector edge must be observed.

One must also remember to leave a minimum of 25 mm clearance in front of the unit, when installing it in a closed cabinet.

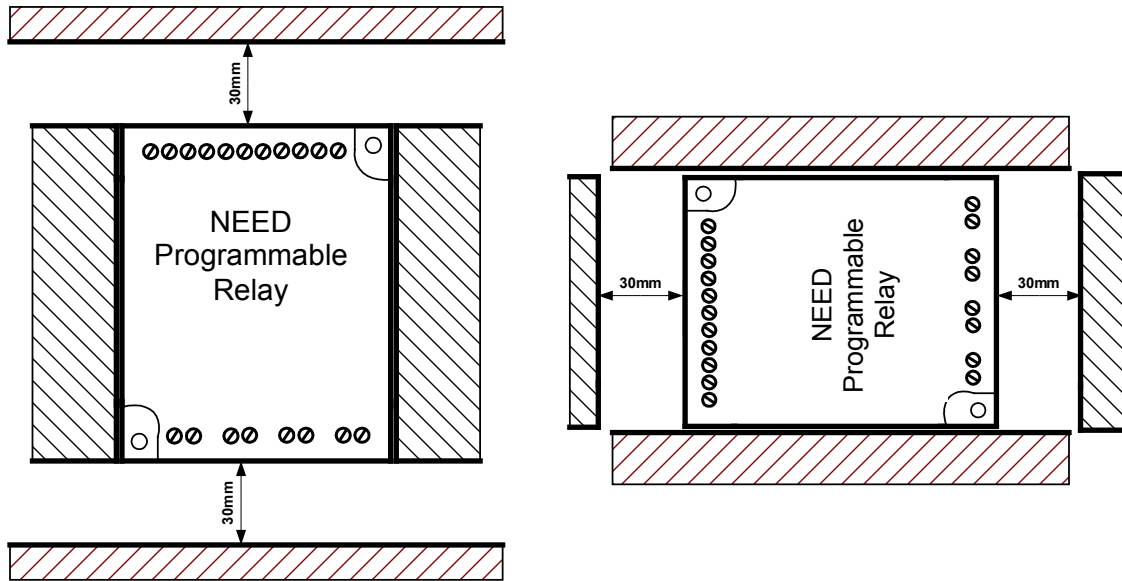

Fig. 3.2.3. Clearances – horizontal and vertical fixing.

3.3. Terminals, cables

The terminals provided allow the use of leads of the following cross-section areas:

from 0.25mm^2 to 4mm^2 - solid cable

from 0.25mm^2 to 2.5mm^2 - stranded cable with sleeve end

Terminal screw tightening torque: 0.5Nm (max 0.6Nm)

- Leads should be as short as practicable but not taut.
- Where long conductors are used they must be screened or twisted in pairs – phase or signal cable (L) with neutral cable (N) or 0V cable with +12(24)V input signal cable for DC version.
- It is recommended to insulate alternating current and direct current circuits, and those generating electrical pulses by laying the cables in an appropriate manner. This can be achieved by avoiding parallel arrangement of power and signal leads, twisting the pairs of wires or screening with screen end being earthed.
- Cross section area of the cable must be selected with regard being paid to the current flowing through the load.



Note: In all cases not explicitly specified in this manual laws, standards, and governmental regulations on electrical systems in force must be applied.

3.4. Connection of 230V AC discrete inputs



Inputs must be connected to the same relay from which power is supplied to the programmable relay.

Reverse connection of the supply power i.e. interchanging the phase conductor (L) and the neutral conductor (N) being connected to the programmable relay inputs may result in dangerous voltages being present on the input terminals and in the non-detection of logic states.



Inputs are not electrically isolated from the electrical system powering the relay.



Electric shock hazard. In case the connection of the neutral conductor (N) is interchanged with that of the phase conductor (L) or if the neutral conductor (N) is not connected, current of the voltage equal to that of the supply current may be present at the terminals.

The following contact parts can be connected to the inputs: push-buttons (normally open, normally closed), connectors, switches, relay contacts, photocells and 2- or 3-wire proximity detectors 230V AC.

Input signal voltage ranges according to PN-EN 61131 standard:

Input off: 0 to 40 V AC (logical '0')

Input on: 85 to 260 V AC (logical '1')

Input current for the NEED-230AC-xx-08-4:

I1 to I4: 0.6 mA at 230 V AC

I5, I6 : 8 mA at 230 V AC improved resistance to interference, possibility of connecting long cables – see technical specification.

I7, I8 : 0,9 mA at 230 V AC

Input current for the NEED-230AC-xx-16-8:

I1 - I11 : 0,6 mA at 230 V AC

I12, I13 : 8 mA at 230 V AC improved resistance to interference, possibility of connecting long cables – see technical specification.

I4, I15, I16 : 1,5 mA at 230 V AC

Inputs are of resistance type except for I5 and I6 inputs for the NEED-230AC-xx-8-.. version and I12, I13 for the NEED-230AC-xx-16-.. (inputs which are of resistance-capacity type) where longer leads can be connected.

Do not use excessively long leads due to their capacitance and susceptibility to electromagnetic interference which can lead to uncontrolled states of logic inputs e.g. signaling of an „ON” state of the input.

Lengths of cables which can be connected depend on the internal input system:

- lead of up to 10 meters can be connected to inputs with normal noise immunity – measurement was made for the worst case of running the phase lead and input lead parallel to each other (for example with a two wire cable).
- cables of lengths up to 100 m can be connected to inputs as they incorporate integral 100 nF capacitors which increase the input current
- similar to the normal noise immunity inputs a cable of the length of up to 10 m can be connected to analogue inputs.



Inputs no. I7 and I8 for the NEED-230AC-xx-8-.. version and I14, I15, I16 for the NEED-230AC-xx-16-.. can be used as discrete or analog inputs – depending on how they are used in the program.

For inputs with higher noise immunity, in order to limit the starting current it is recommended that an approx. 1kΩ 1W resistor (fig. 3.4.2) be connected in series with the contact component (fig. 3.4.2. shows a connection for the NEED-230AC-xx-8-.. version). Inputs I5, I6 for the NEED-230AC-xx-8-.. version and I12, I13 for the NEED-230AC-xx-16-.. with internal capacitors can be shunted with external resistors (100kΩ) put between the input and the N lead so that their capacity can be discharged in a shorter time.

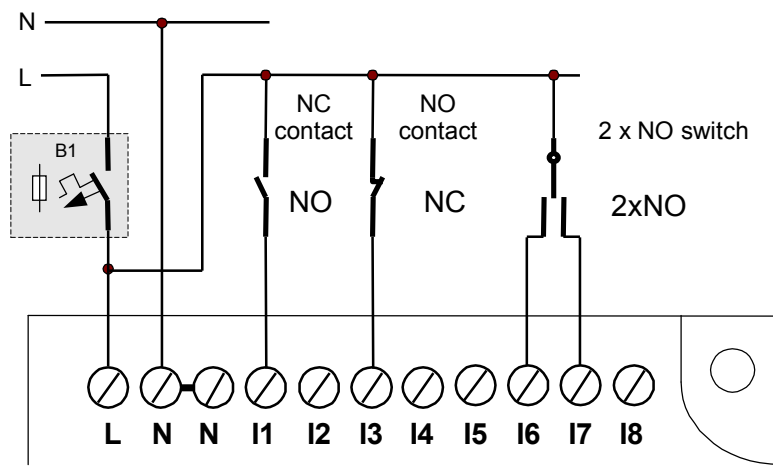

Fig 3.4.1. Input connections – contact elements.

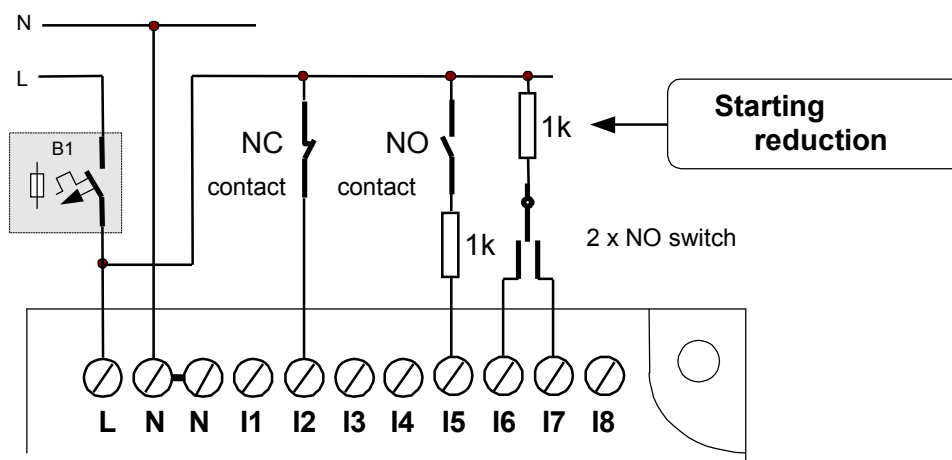

Fig 3.4.2. Input connections – contact elements + resistors reducing the input current surge.

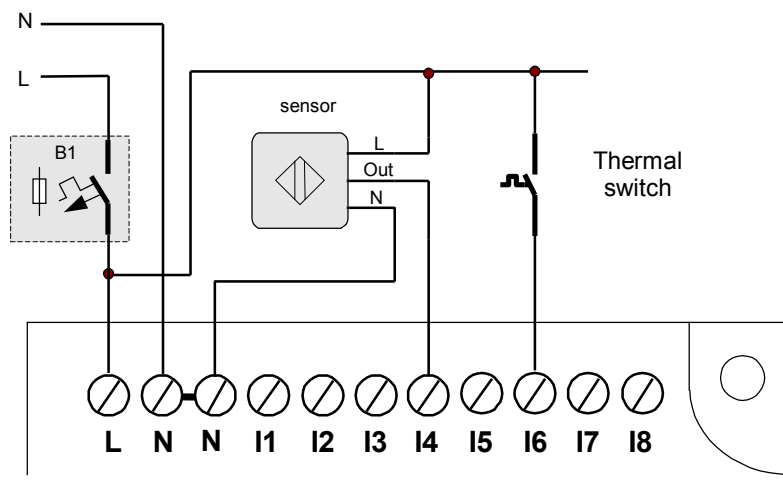

Fig 3.4.3. Input connections – proximity sensor + thermal switch contact.



In order to reduce interference at discrete inputs Nos. I1...I4, I7, I8 and increase the lengths of cables which may be used to connect control units to those inputs, external elements must be used which increase the current in the circuit, and input filters.

1. Increasing the current in the input circuit

In order to reduce interference at inputs Nos. I1...I4, I7, I8 an external capacitor can be used e.g. 100nF/275V class X1 or X2 (increase of current) to be connected between the input terminal and the N terminal (Fig. 3.4.4)

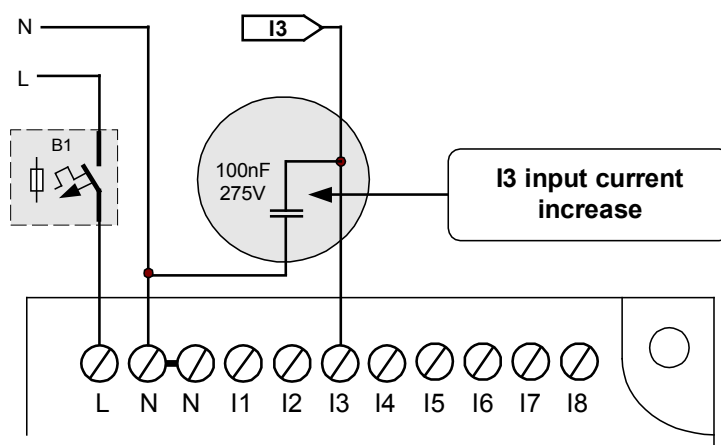

Fig 3.4.4. Input current increase.

2. RC filter

In order to reduce interference at inputs Nos. I1...I4, I7, I8 an RC filter can be used (capacitor 100nF/275V class X1 or X2 connected in series and 1kΩ resistor) to be connected between the input terminal and the N terminal (Fig. 3.4.5).

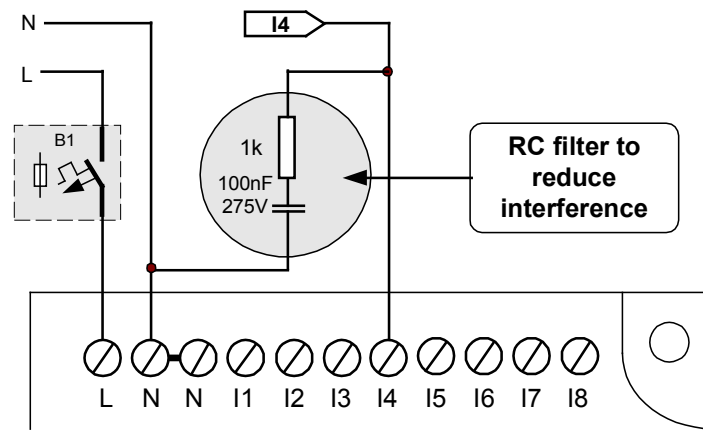

Fig 3.4.5. Input RC filter.



Note: Feeding a voltage higher than the maximum permissible between the I1..In and N input terminals can result in damaging the input circuits of the programmable relay.

3.5. Connection of 220V DC discrete inputs



Electric shock hazard.



Note: Feeding a voltage higher than the maximum permissible between the I1..In and 0V input terminals can result in damaging the input circuits of the programmable relay.



Inputs are not electrically isolated from the electrical system powering the relay.

The following contact parts can be connected to the inputs: push-buttons (normally open, normally closed), connectors, switches, relay contacts, photocells and others detectors 220V DC.

Input signal voltage ranges according to EN 61131 standard:

Input off: 0 to 40 V DC (logical '0')

Input on: 85 to 260 V DC (logical '1')

Input current for the NEED-220DC-xx-08-4:

I1 to I6: 0.6 mA at 220 V DC

I7, I8 : 1,1 mA at 220 V DC

Input current for the NEED-220DC-xx-16-8:

I1 - I13 : 0,6 mA at 220 V DC

I4, I15, I16 : 1,1 mA at 220 V DC

Do not use excessively long leads due to their capacitance and susceptibility to electromagnetic interference which can lead to uncontrolled states of logic inputs e.g. signaling of an „ON” state of the input.

Lengths of cables which can be connected depend on the internal input system:

- lead of up to 10 meters can be connected to inputs with normal noise immunity – measurement was made for the worst case of running the parallel to each other (for example with a two wire cable).
- a shielded cable of the length of up to 10 m can be connected to analogue inputs.



Inputs are of resistance type.

Inputs no. I7 and I8 for the NEED-220DC-xx-8-.. version and I14, I15, I16 for the NEED-220DC-xx-16-.. can be used as discrete or analog inputs – depending on how they are used in the program.

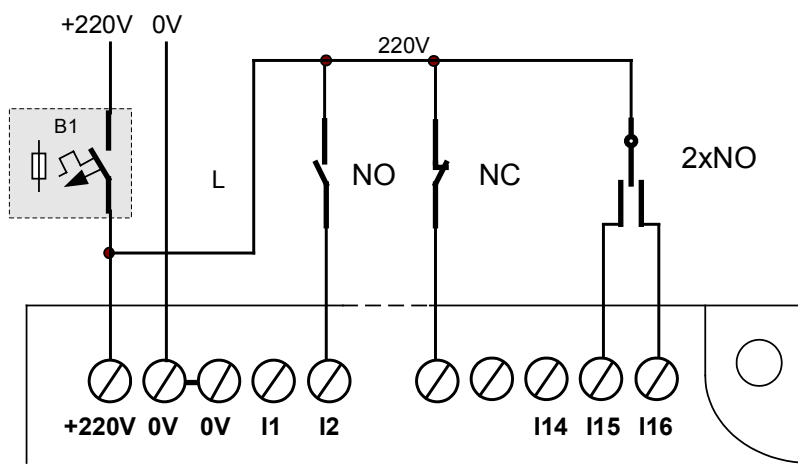

Fig 3.5.1. Input connection – contact components.

3.6. Connection of 24V (12V) DC discrete inputs

The following contact parts can be connected to the input terminals: push-buttons (normally open, normally closed), connectors, switches, relay & contactor contacts, photocells and 2- or 3-wire proximity detectors 24V (12V) DC.

Input signal voltage ranges are according to EN 61131 standard.

Table 3.6.1. & 3.6.2. includes digital input parameters depending on the voltage version of the relay.

Table 3.6.1. **NEED-..DC-xx-8-..** Programmable relay input parameters.

Supply voltage	Input	Input signal range		Input current	Input resistance
		Input OFF	Input ON		
V	nr	V	V	mA	kΩ
24 DC	I1..I6	-3..5	15..30	3.3	7.44
	I7..I8	-3..5	15..30	2	12.36
12 DC	I1..I6	-1..4	8..26	3.3	3.65
	I7..I8	-1..4	8..26	3.3	10.92

Table. 3.6.2. **NEED-..DC-xx-16-..** Programmable relay input parameters

Supply voltage	Input	Range of input signals		Input current	Input resistance
		Cut-off input	Start input		
V	no.	V	V	mA	kΩ
24 DC	I1..I13	-3..5	15..30	3.3	7.44
	I14..I16	-3..5	15..30	2	12.36
12 DC	I1..I13	-1..4	8..26	3.3	3.65
	I14..I16	-1..4	8..26	3.3	10.92

If inputs I14..I16 are configured as current inputs then their impedance is 49 Ω.



Note: Feeding a voltage higher than the maximum permissible between the I1..In and 0V input terminals can result in damaging the input circuits of the programmable relay.



Inputs are of the resistance type.
Inputs no. I7 and I8 for the NEED..-xx-8-.. version and I14, I15, I16 for the NEED..-DC-xx-16-.. can be used as discrete or analog inputs – depending on how they are used in the program.

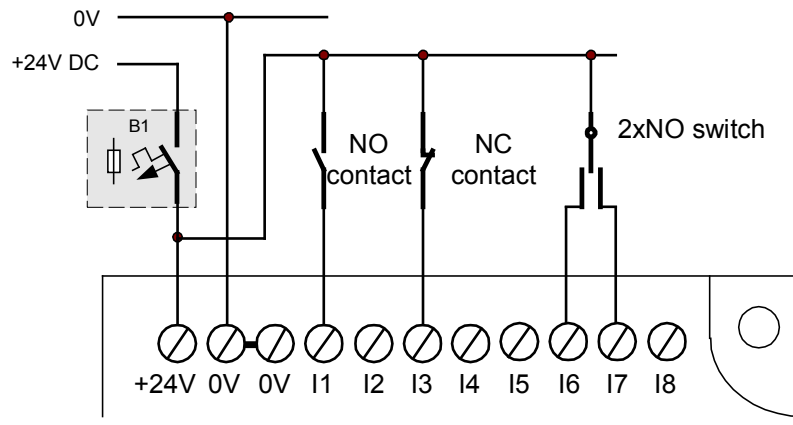

Fig 3.6.1. Input connection – contact components.

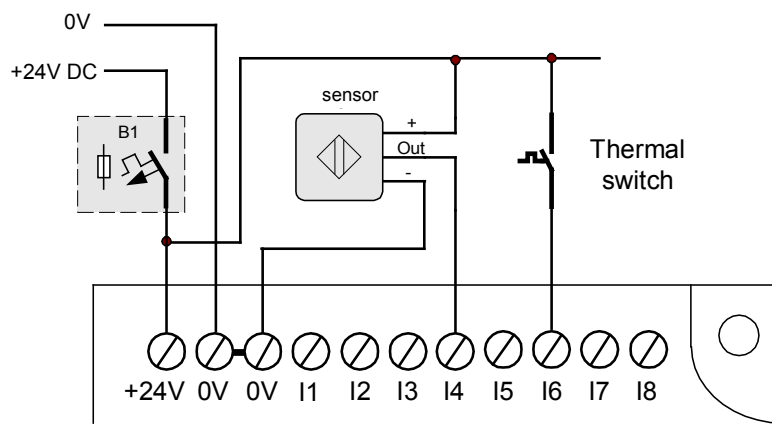

Fig 3.6.2. Input connection – proximity sensor, thermal switch contact.

3.7. Analogue AC input connections



Electric shock hazard. In case the connection of the neutral conductor (N) is interchanged with that of the phase conductor (L) or if the neutral conductor (N) is not connected, current of the voltage equal to that of the supply current may be present at the terminals.



Analogue inputs are not electrically isolated from the mains powering the relay.

Input signal voltage ranges for analogue inputs are 0 to 255 V AC; with the accuracy of +/- 3% of the measurement range value.



Phase and frequency of the current measured need not to be equal to those of the supply current in order for the analogue measurement to be correct.



However, if the analogue inputs are to be used as digital ones both the inputs and current supplying the programmable relay must be connected to the same phase.



Analogue inputs can be used as discrete ones. In such a case discrete input connection principles must be followed – see above.

Analogue measurement is performed using an averaging circuit. The result is shown in the root-mean-square current.

Due to averaging the measurement on analogue inputs is delayed.

Input voltage (measured) must be stable for a while in order for the measurement to be accurate.

Analogue inputs for the NEED-230AC-xx-8-4 version

In relays of this type these are the last two inputs no. I7 and I8.

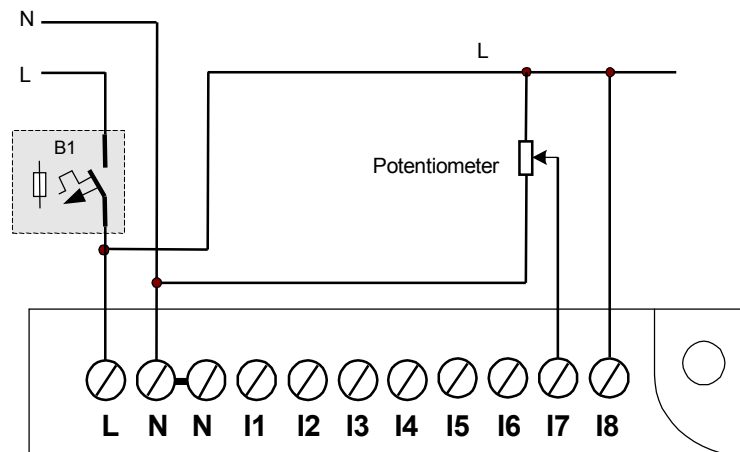

Connecting to a three-phase network is not allowed

Fig. 3.7.1. Analogue inputs – potentiometer, network voltage control - NEED-230AC-01-8-...

Analogue inputs for the NEED-230AC-xx-16-8 version

In relays of this type these are the last three inputs no. I14, I15 and I16.

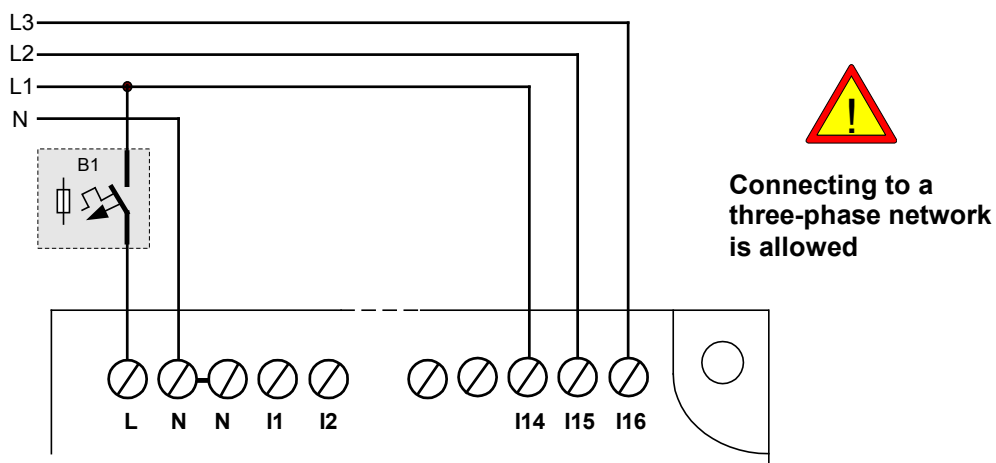

Fig. 3.7.2. Analogue inputs –network voltage control - NEED-230AC-01-16-...

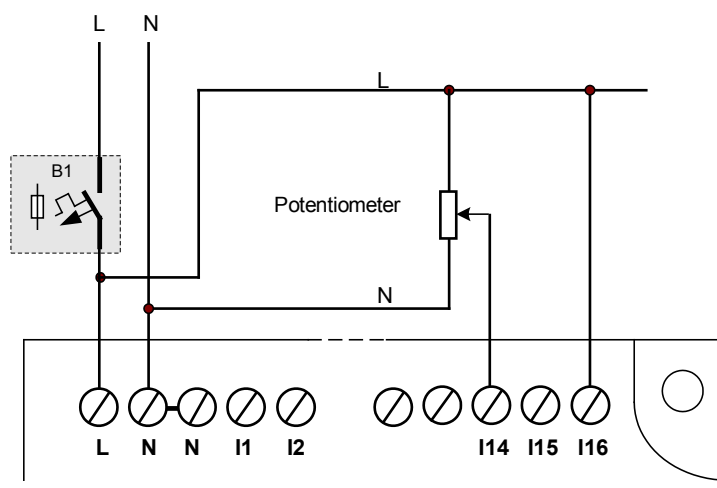

Fig. 3.7.3. Analogue inputs – potentiometer - NEED-230AC-01-16-...

In the NEED-230AC-.. loading times for *Timers* and thresholds for *Counters* is not available.



Note: Remember that the parts connected must be of appropriate power and rated operating voltage.



Note: Remember that the analogue input is power consuming which may cause the measurement results to be inaccurate if the self-impedance of the source of the voltage measured is too high.



Caution: Components such as potentiometers, switches etc. must be carefully insulated due to the electric shock hazard.

3.8. Analogue 220 DC input connections



Electric shock hazard



Analogue inputs are not electrically isolated from the mains powering the relay.



Input signal voltage ranges for analogue inputs are 0 to 255 V DC (step 1V); with the accuracy of +/- 2% of the measurement range value.



Analogue inputs can be used as discrete ones. In such a case discrete input connection principles must be followed – see above.

Analogue measurement is performed using an averaging circuit. The result is shown in the root-mean-square current.

Due to averaging the measurement on analogue inputs is delayed.

Input voltage (measured) must be stable for a while in order for the measurement to be accurate.

Analog inputs for the NEED-220DC-xx-8-4 version

In relays of this type these are the last two inputs no. I7 and I8.

Analog inputs for the NEED-220DC-xx-16-8 version

In relays of this type these are the last three inputs no. I14, I15 and I16.

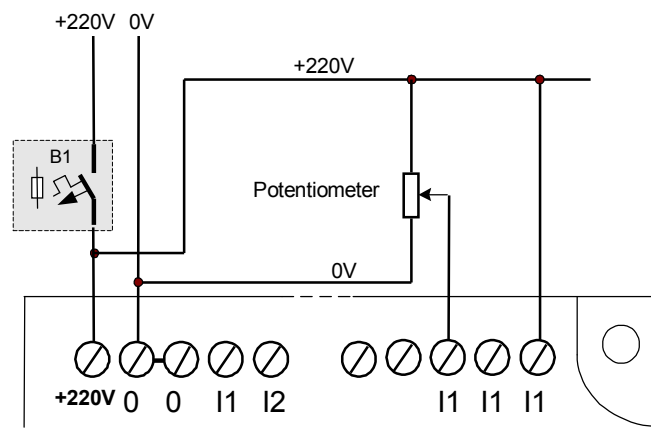

Fig. 3.8.1. Analogue inputs - NEED-220DC-x1-16-8.



Note: Remember that the parts connected must be of appropriate power and rated operating voltage.



Note: Remember that the analogue input is power consuming which may cause the measurement results to be inaccurate if the self-impedance of the source of the voltage measured is too high.



Caution: Components such as potentiometers, switches etc. must be carefully insulated due to the electric shock hazard.

3.9. Analogue 24V (12V) DC input connection

The range of input signals for analog inputs configured as voltage inputs is 0–25.5V DC (in 0.1V steps) or 0 – 12.75V (in 0.05V steps).

The range of input signals for analog inputs configured as current inputs is 0–51 mA (in 0.2 mA steps) or 0 – 25.5 mA (in 0.1 mA steps).

Accuracy of +/- 2 % of the measurement range value

Resolution of analog inputs: 8 bit.



Analogue inputs can be used as discrete ones. In such a case discrete input connection principles must be followed – see above.

Analogue inputs are I7 and I8 for the DC NEED..-xx-8-.. version and I14, I15, I16 for the NEED..-xx-16-... version.

The diagram below presents a circuit for setting the voltage at I7 input and controlling the power supply voltage via I8 input connected to “+” of the relay power supply. Such connection allows using the potentiometer to adjust not only the comparator thresholds but also to set times for the Timers and adjust thresholds of the Counters.

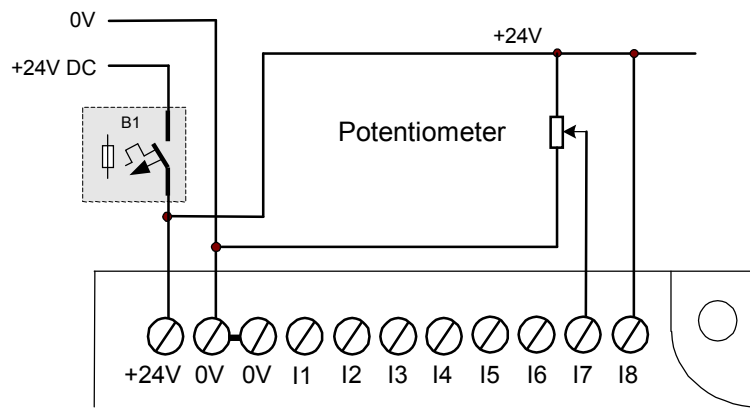

Fig. 3.9.1. Analogue inputs – potentiometer.

Analogue inputs in the NEED relay make it possible to read external voltage in the range of 0V ÷ 25.5V (or 0V..12.5V for the NEED-24DC-x1-16-.. version). The connection arrangement for the external voltage source for the NEED-24DC-xx-8-.. version is presented in fig. 3.7.2.

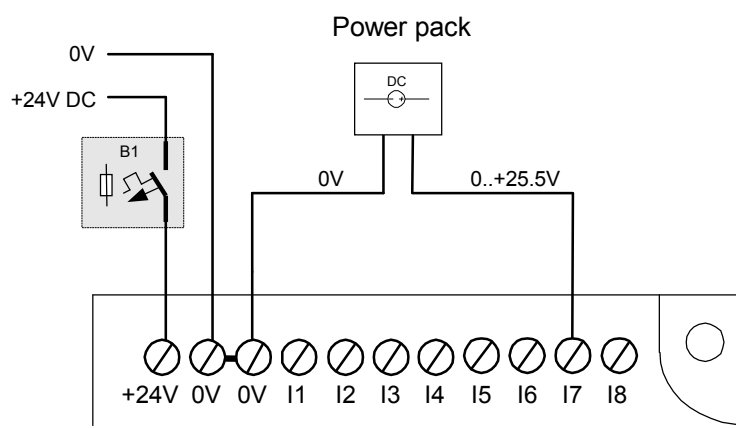

Fig. 3.9.2. Analogue inputs – range.



Note: Remember that the parts connected must be of appropriate power and rated operating voltage.



Note: Remember that the analogue input is power consuming which may cause the measurement results to be inaccurate if the self-impedance of the source of the voltage measured is too high.

Transducer 0..10V DC

Various types of electric transducers (voltage, current, frequency transducers) or non-electric transducers (temperature, pressure, force transducer) equipped with standard analogue voltage or current outputs, can be connected to the analogue inputs. For voltage transducers generating voltage of 0 to 10V for the minimum and maximum value of the parameter converted, a 100-point conversion characteristics is obtained.

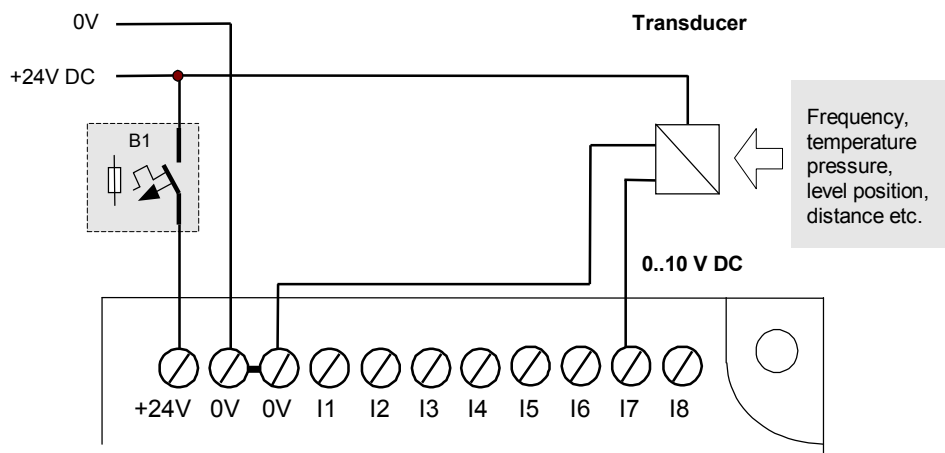

3.9.3 Analogue inputs – transducer 0..10.

Transducer 0..20 mA

The NEED-24DC-xx-8-4 and NEED-12DC-xx-8-4 do not have a built in current/voltage converter.

In order to use a transducer with current output of the range of 0..20 mA or 4..20 mA a simple current converting circuit must be used. This can be obtained by measuring the voltage drop at the 510Ω resistor constituting the transducer load. The voltage drop is proportional to the value of the current according to the ratio: 1 mA = ~ 0.5V. The calculations account for the self-resistance of the analogue input of the transducer.

Characteristic conversion points for 24V DC version are:

- 1mA → ~0,5V
- 4mA → ~1,9V
- 10mA → ~4,9V
- 20mA → ~9,8V

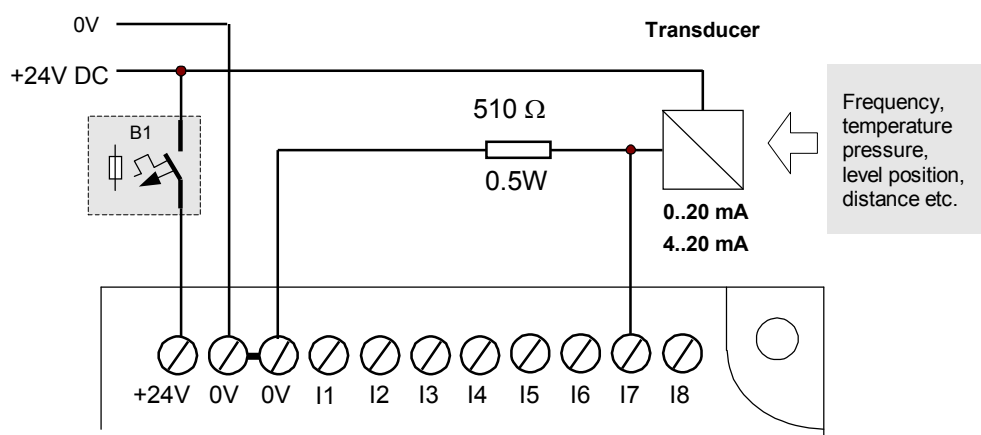

3.9.4. Analogue inputs – transducer 0..20 mA for the NEED-24DC-x1-08-4 version.

The NEED-24DC-xx-16-8 and NEED-12DC-xx-16-8 have a built in current/voltage converter. Converters with current output can be connected directly to the AI14, AI15, AI16 inputs of the relay after they are configured in the PC Need program as current inputs (I) or downloading the settings into the relay.

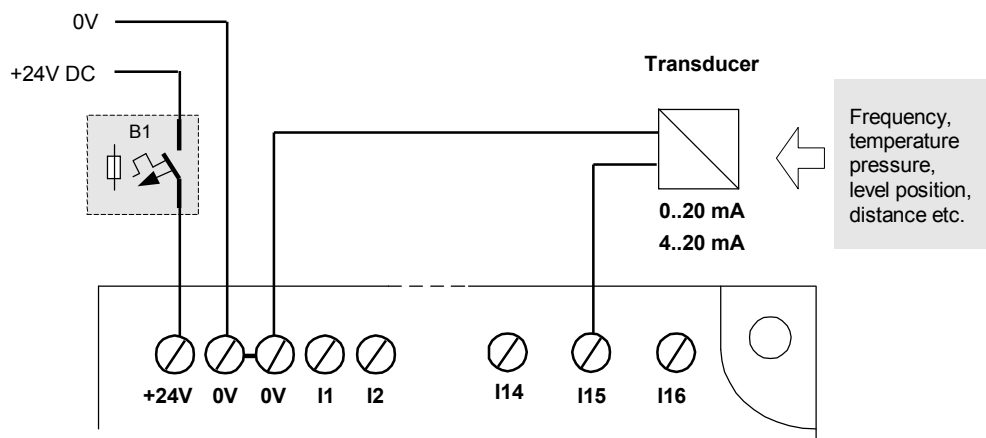

Fig. 3.9.5. Analog inputs – 20mA converter for the NEED-24DC-x1-16-8 version.



Note: Feeding a voltage higher than the maximum permissible between the analog input terminals and 0V can result in damaging the input circuits of the programmable relay.



Note: Voltage should not be supplied to inputs AI14, AI15, AI16 set as current inputs.



Note: Connecting a voltage source to inputs no. AI14, AI15, AI16 set as current inputs can damage them. The maximum input voltage for $I=51\text{mA}$ is 2.5V.



Note: Feeding voltage from a source higher than 51mA to inputs AI14, AI15, AI16 set as current inputs will trip the internal safety device. The relay has an input sampling cycle.

3.10. Output connection

3.10.1. Relay outputs

Output terminals are connected to the contacts of the Q1..Qn inner electromagnetic relays. The NEED..-xx-8-4R version includes 4 relay outputs. The extended NEED..-xx-16-8R version includes 8 relay outputs.

Outputs are potential-free and electrically isolated from the rest of the system and from one another – independent control systems can be constructed.

Load capacity of one output – see technical specification - 230V 10A for resistant loads.

Relay-controlled output circuits must be appropriately protected (fuse) depending on the power and nature of the load, in order not to exceed the values indicated in the technical specification.

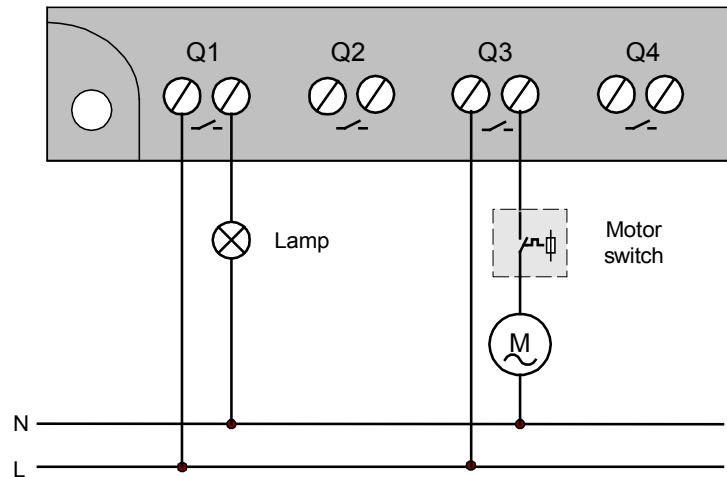

Fig. 3.10.1. Relay outputs – 230V AC mains supply.

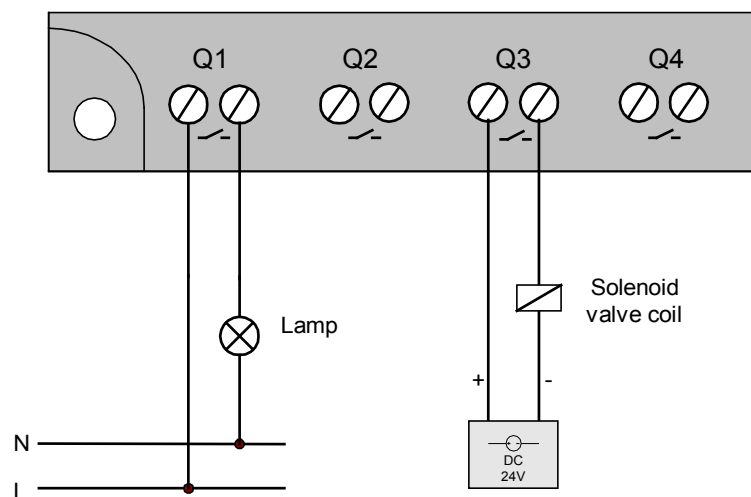

Fig. 3.10.2. Relay outputs – various external circuits.

3.10.2. Transistor outputs

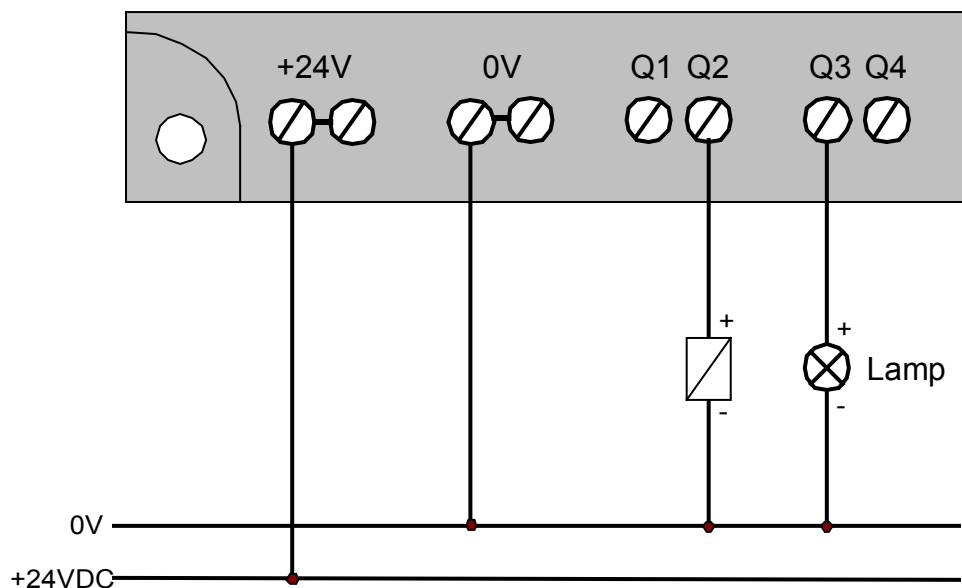

Fig. 3.10.3. Transistor outputs – various external circuits for NEED-24DC...-08-4T

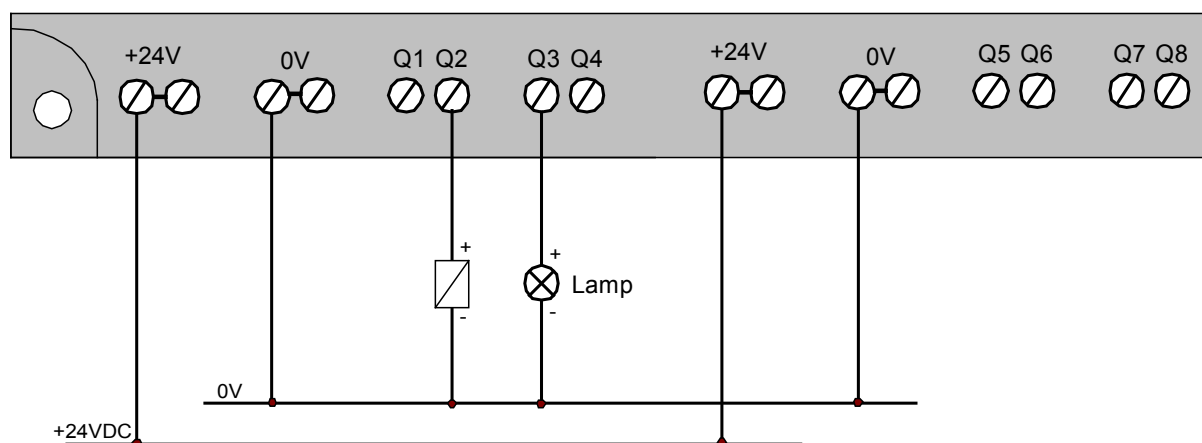

Fig. 3.10.4. Transistor outputs – various external circuits for NEED-24DC...-16-8T

3.11. AC power supply connection



Supply voltage is dangerous to life!

User's safety depends on the quality of the connections!

Observe correct connection of supply voltage conductors – phase conductor (L) and neutral conductor (N).



Interchanging the connections of conductors to the power supply inputs i.e. connecting the phase conductor (L) to the N-terminal and connecting the neutral conductor (N) to the L-input terminal of the programmable relay may result in dangerous voltages being present on the I1...I8 input terminals and the communication ports, and in non-detection of logic states.



Rated supply voltage: **115/230V AC ; 50/60Hz**



Supplying 400 V AC phase-to-phase voltage between L and N terminals will destroy the programmable controller.

Protect the programmable relay with a fuse of rated current of 1A. Certainly the protection level cannot be excessively high as it will not perform the intended function – the recommended maximum value is 6A.

Should the protection be common for inputs and outputs, the protection current of the programmable relay power supply of min. 1A must be taken into account.

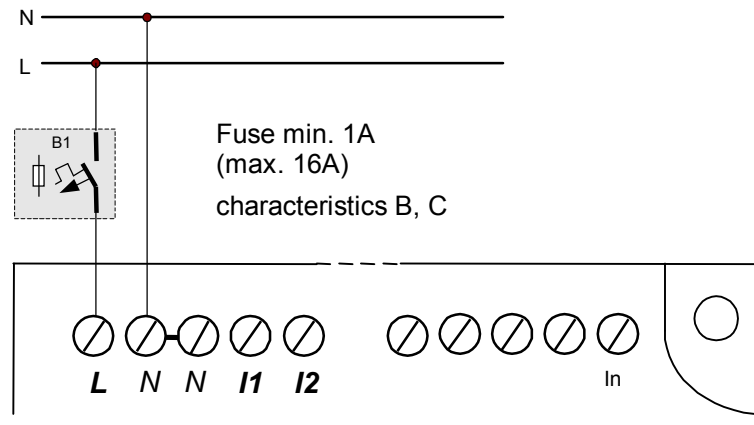

Fig. 3.11.1. Programmable relay power supply (115/230 V AC).

3.12. 220 DC power supply connection



Supply voltage is dangerous to life!

User's safety depends on the quality of the connections!



Interchanging the connections of conductors to the power supply inputs of the programmable relay may result in dangerous voltages being present on the I1...In input terminals and the communication ports, and in non-detection of logic states.



Rated supply voltage: **220V DC**.



Note: Feeding a voltage higher than the maximum permissible between the +220V and 0V terminals can result in damaging the programmable relay.

Protect the programmable relay with a fuse of rated current of 1A. Certainly the protection level cannot be excessively high as it will not perform the intended function – the recommended maximum value is 16A.

Should the protection be common for inputs and outputs, the protection current of the programmable relay power supply of min. 1A must be taken into account.

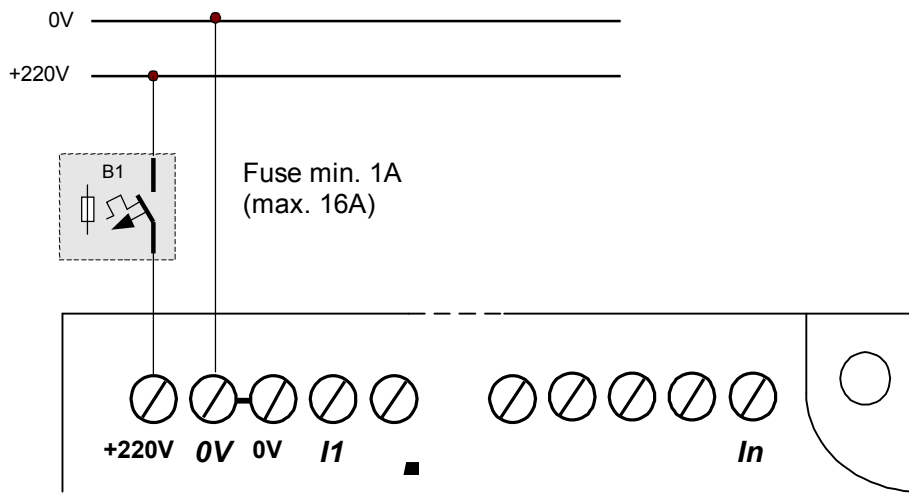

Fig. 3.12.1. Programmable relay power supply (220 V DC).

3.13. 24V (12V) DC power supply connection

The rating of the fuse to protect the cables should be greater than 1A as a current surge occurs when switching on the unit, due to the charging of the internal capacitor located in the relay power pack.

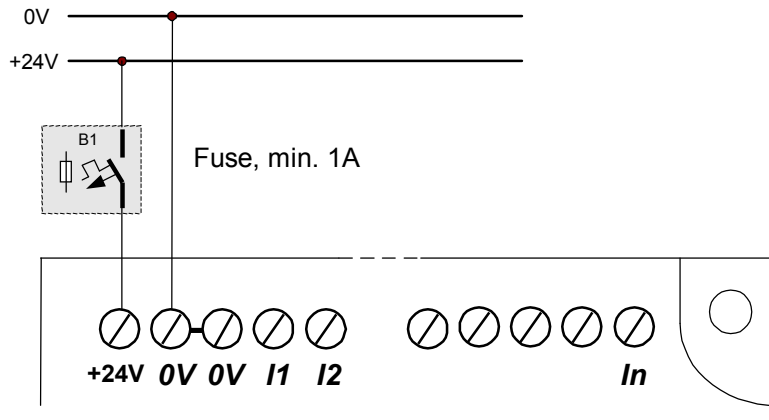

Fig. 3.13.1. Programmable relay power supply (NEED-24DC-..).

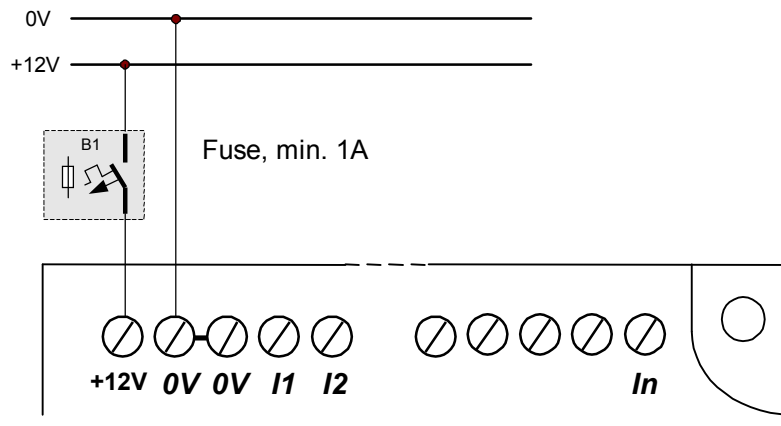

Fig. 3.13.2. Programmable relay power supply (NEED-12DC-..).



Note: Feeding a voltage higher than the maximum permissible between the +24V (+12V) and 0V terminals can result in damaging the programmable relay.

4. RELAY RESOURCES

Programmable relays are devices, which incorporate two basic components: central processing unit including memory, and peripherals – inputs/outputs. Obviously, to provide full functionality some programming unit and a cable for communication with the controller are necessary. NEED Programmable Relay has all those components.

4.1. NEED Programmable Relay system

1. An application for editing, compiling and loading the program to the PC memory.
2. External relay memory (not necessary but facilitates transfer of the program between the PC and the relay).
3. Programmable relay.

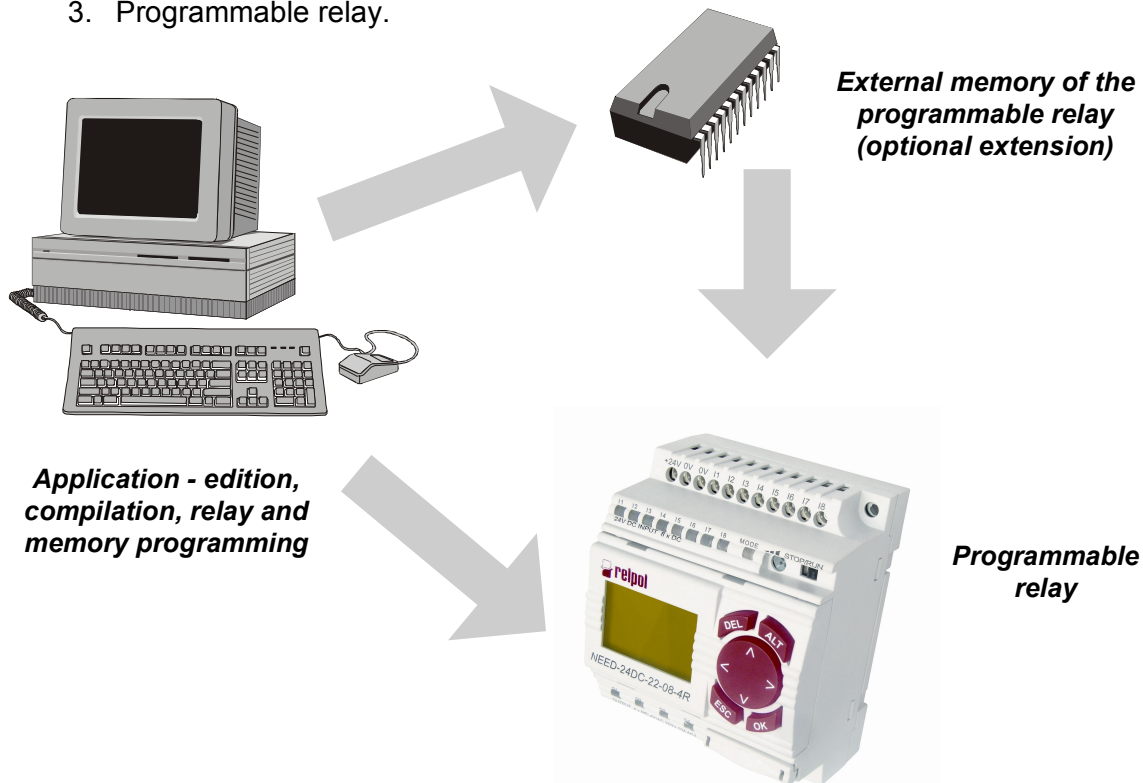

Fig. 4.1.1 NEED Programmable Relay system.

4.2. Program cycle

In order to run various applications using the programmable relay first of all an appropriate program must be created and placed in the controller's memory. Once run, the controller starts processing the program from the first instruction to the last. The cycle is then repeated. At the beginning of each cycle the input states are written in special memory areas. During program execution references are made to copies of input/output states written in the memory mapping the process and not directly to the input/output states. The same procedure is followed for output signals. The controller stores those states in the process mapping memory and only after the end of each cycle the states are copied to the relay outputs.

Controller operating cycle is presented in Fig. 4.2.1.

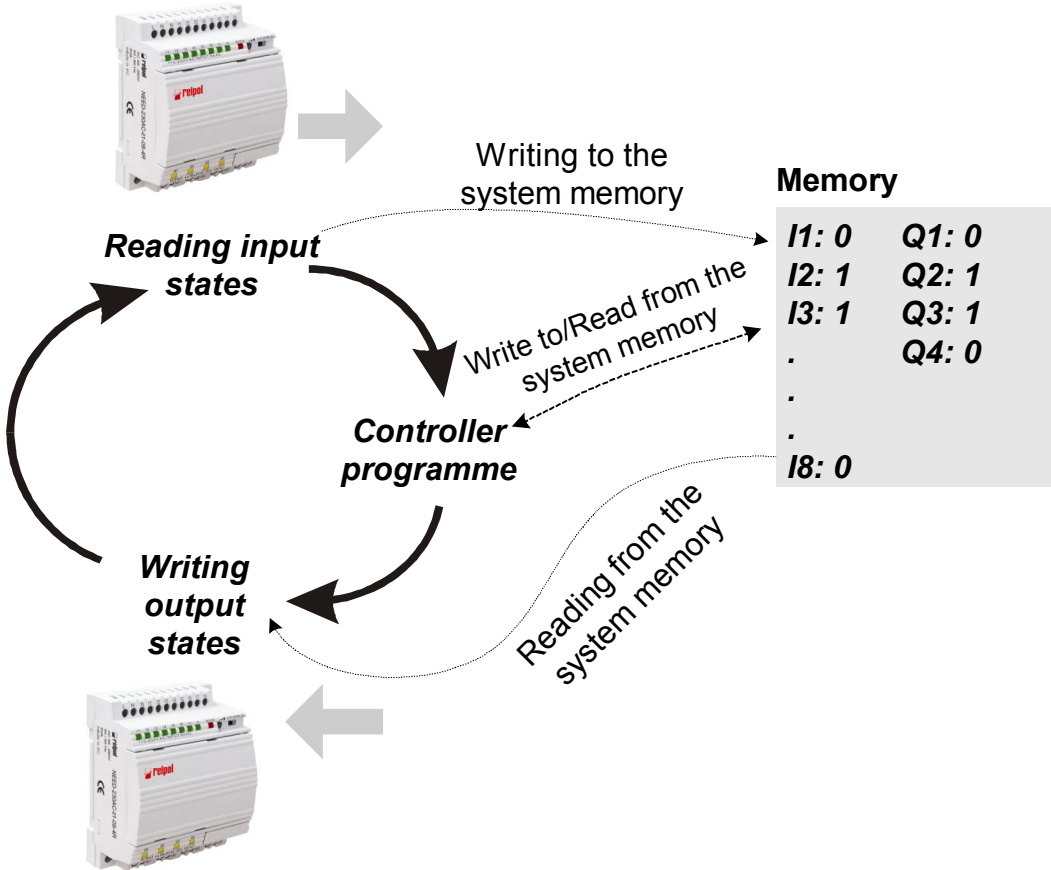

Fig.4.2.1. Controller operating cycle.

Good knowledge of the NEED Programmable Relay resources is required to properly understand and program that relay.

4.3. NEED Programmable Relay resources

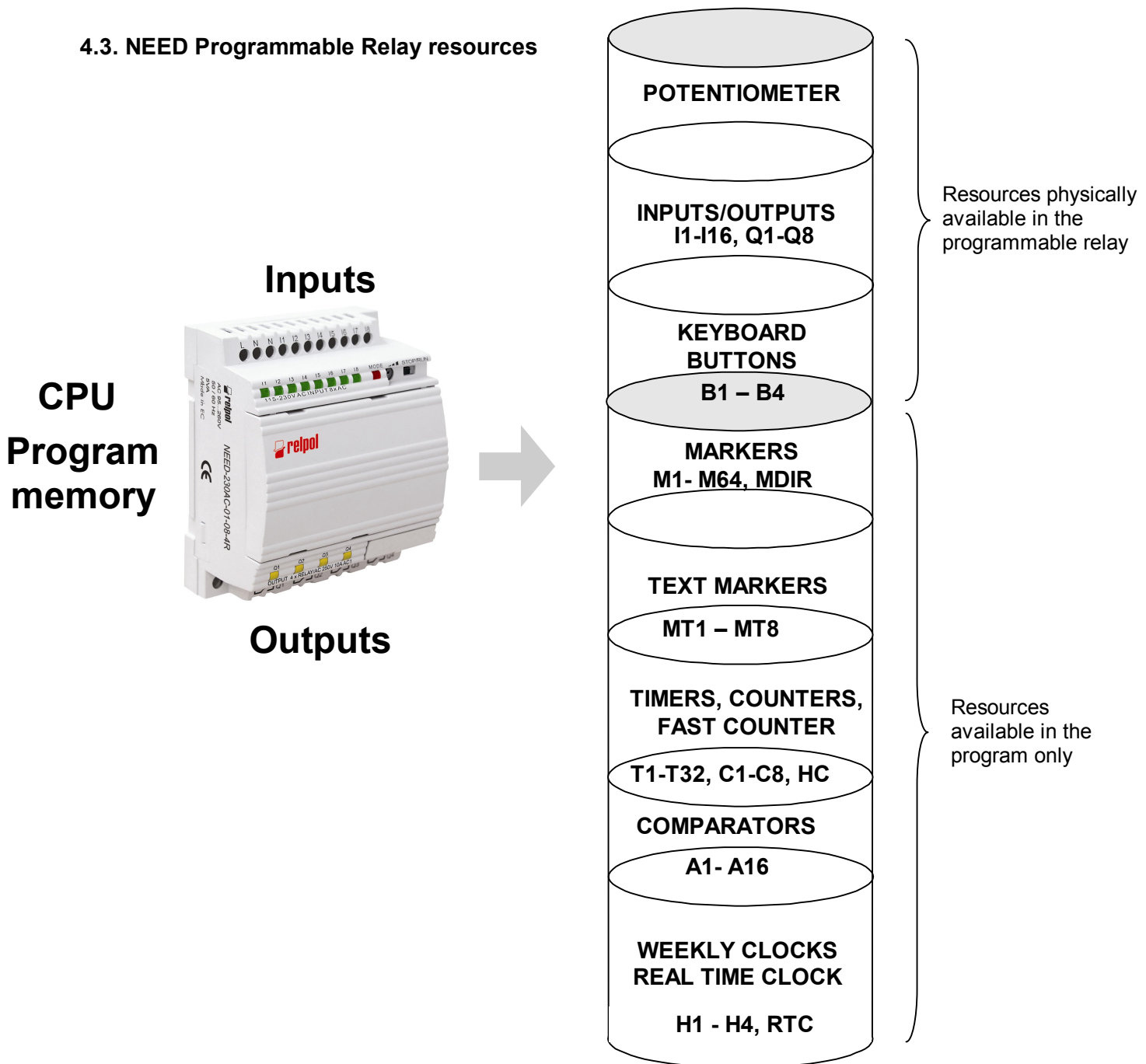

Fig.4.3.1. NEED programmable relay resources.

Communication between the NEED relay and the external devices is carried out via outputs and inputs. These are practically the only resources, noticeable to users, which may be a basis for creating even very complex applications. But the actual power of each relay is determined by its internal resources – “invisible” from the outside, accessible only to the program. The Fig. 4.3.1. illustrates, in a symbolic manner, the resources of the programmable relay while Table 4.3 shows quantities of individual components comprised by the relay system structure.

Proper use and utilization of the resources of the NEED programmable relay depend on the user. Below please find a description of individual components and writing methods for different programming languages.

Table 4.3. NEED programmable relay resources.

Name	Quantity NEED-..x1- 08- 4	Quantity NEED-..-11-16- 8
"I" digital Inputs	I1 – I8 the I7,I8 inputs can also be used as analog inputs	I1 – I16 the I14, I15, I16 inputs can also be used as analog inputs
"Q" NO type relay digital outputs	Q1 – Q4	Q1 – Q8
Comparators "A"	A1 – A8	A1 – A12
Markers "M"	M1 – M16	M1 – M16
MDIR marker Defining the direction of connection of the L1, L2, L3 phases		MDIR
Timers "T"	T1 – T8	T1 – T16
Counters "C"	C1 – C8	C1 – C8
Fast counter HC up to 20kHz		HC1
Real time clock	Yes	Yes
Automatic change of summer/winter time in different time zones	No	Yes
Weekly clocks "H"	H1 – H4	H1 – H4

Table 4.3. NEED programmable relay resources – continuation.

Name	Quantity NEED-..-22- 08- 4	Quantity NEED-..-22-16- 8
“I” digital Inputs	I1 – I8 the I7,I8 inputs can also be used as analog inputs	I1 – I16 the I14, I15, I16 inputs can also be used as analog inputs
“Q” NO type relay digital outputs	Q1 – Q4	Q1 – Q8
Comparators “A”	A1 – A8	A1 – A12
Markers “M”	M1 – M64	M1 – M64
MDIR marker Defining the direction of connection of the L1, L2, L3 phases		MDIR
Timers “T”	T1 – T32	T1 – T32
Counters “C”	C1 – C8	C1 – C8
Fast counter HC up to 20kHz	HC1	HC1
Automatic change of summer/winter time in different time zones	Yes	Yes
Real time clock	1	1
Weekly clocks “H”	H1 – H8	H1 – H8
Keyboard buttons	B1 – B4	B1 – B4

4.4. Digital inputs

Each of the 8 inputs may be configured as normally open or normally closed. Those resources represent physical inputs of the programmable relay.

4.4.1. Normally open digital inputs.

Symbols of normally open digital inputs.

STL	LAD
A I1 or O I1 or X I1	I1 

SYMBOL: **In**, „n” being the input number n=1..8 ; NEED-...-08-..
n=1..16 ; NEED-...-16-..

LOGICAL STATES:

‘1’ – supply voltage present at the input.

‘0’ – no supply voltage present at the input.

4.4.2. Normally closed digital inputs.

Symbols of normally closed digital inputs.

STL	LAD
AN I1 or ON I1 or XN I1	I1 

SYMBOL: **In**, „n” being the input number n=1...8 ; NEED-...-08-..
n=1...16 ; NEED-...-16-..

LOGICAL STATES:

‘0’ – supply voltage present at the input.

‘1’ – no supply voltage present at the input.

4.5. Digital outputs

Digital outputs can be of different types. However, it must be remembered that there are max. 8 physical outputs available!

4.5.1. Normal digital outputs.

Symbols of normal digital outputs.

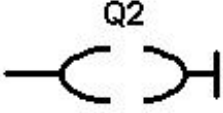
STL	LAD
= Q2	

SYMBOL: **Qn**, „n” being the output number, n=1..4 ; NEED-..-08-..
n=1..8 ; NEED-..-16-..

LOGIC STATES:

'1' – contacts closed.

'0' –contacts open.

This type of output works like an ordinary relay i.e. the coil, when energised, triggers the relay actuation.

4.5.2. Digital pulse outputs.

Symbols of digital pulse outputs.

STL	LAD
FP Q2	

SYMBOL: **Qn**, „n” being the output number, n=1..4 ; NEED-..-08-..
n=1..8 ; NEED-..-16-..

LOGIC STATES:

'1' – if the previous state was '0' and a logical positive control edge occurred.

'0' – if the previous state was '1' and a logical positive control edge occurred.

This output acts like a flip-flop which, when actuated by a rising edge, changes the state of its output to the opposite one.

4.5.3. Digital resetting outputs.
 Symbols of digital resetting outputs.

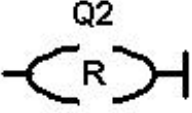
STL	LAD
R Q2	

SYMBOL: **Qn**, „n” being the output number, n=1..4 ; NEED-...-08-..
 n=1..8 ; NEED-...-16-..

LOGICAL STATES:
 '0' – if the control state '1' occurred.

4.5.4. Digital setting outputs.
 Symbols of digital setting outputs.

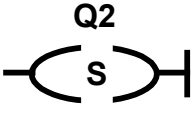
STL	LAD
S Q2	

SYMBOL: **Qn**, „n” being the output number, n=1..4 ; NEED-...-08-..
 n=1..8 ; NEED-...-16-..

LOGICAL STATES:
 '1' – if the control state '1' occurred.

4.5.5. Normal digital outputs used for further control.
 Symbols of normal digital outputs used for further control.

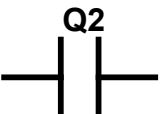
STL	LAD
A Q2 or O Q2 or X Q2	

SYMBOL: **Qn**, „n” being the output number, n=1..4 – NEED-...-08-..
 n=1..8 – NEED-...-16-..

LOGIC STATES:
 '1' – if the physical output state is '1'.
 '0' – if the physical output state is '0'.

4.5.6. Inverted digital outputs used for further control.
 Symbols of digital outputs used for further control.

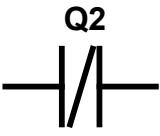
STL	LAD
AN Q2 or ON Q2 or XN Q2	

SYMBOL: **Qn**, „n” being the output number, n=1..4 – NEED-...-08-..
 n=1..8 – NEED-...-16-..

LOGICAL STATES:

'1' – if the physical output state is '0'.
 '0' – if the physical output state is '1'.

4.6. Markers

4.6.1 Markers

A Marker is a logical element which is treated as a variable used in the program. It has its internal state '0' or '1'.

No specific input or output can be physically connected with a marker but it can be used for connecting logical program structures. Thus markers can be treated as 16 reserved bits which can be referred to as inputs or outputs, i.e. they are subject to the same „operations” (instructions) as the inputs and outputs are but they have no physical representation in the form of contacts.

The marker symbol **M** appears in the syntax of the instruction or the graphic to replace the letter I or Q.

SYMBOL: **Mn**, „n” being the number within the range of n=1..16 dla NEED-...-x1-..
 n=1..64 dla NEED-...-22-..

LOGICAL STATES:

'0' or '1' – depending on the function in the program

Symbols of Markers

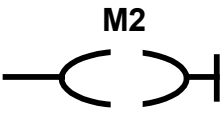
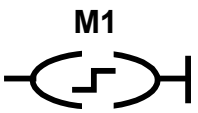
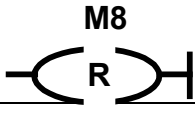
STL	LAD
= M2	
FP M1	
R M8	

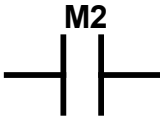
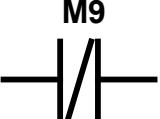
S M4	
A M2 or O M2 or X M2	
AN M9 or ON M9 or XN M9	

4.6.2. MDIR Marker



For the NEED-230VAC-11-16-8 version, in addition to the aforementioned 16 *Markers* the MDIR *Marker* also exists.

The MDIR *Marker* defines the direction of phases no. L1, L2, L3 connected to the I14, I15, I16 inputs. If phase L1 is connected to I14, L2 to I15, L3 to I16 then MDIR assumes the value of '1', otherwise the MDIR value is '0'.

The MDIR *Marker* is read only.

Figures 4.6.2.1 and 4.6.2.2 show examples of connections, where MDIR takes the successive values of '1' and '0'.

If the supply cable is not connected to one of the analog inputs (I14, I15, I16), then the MDIR marker takes a random value— figure 4.6.2.3.

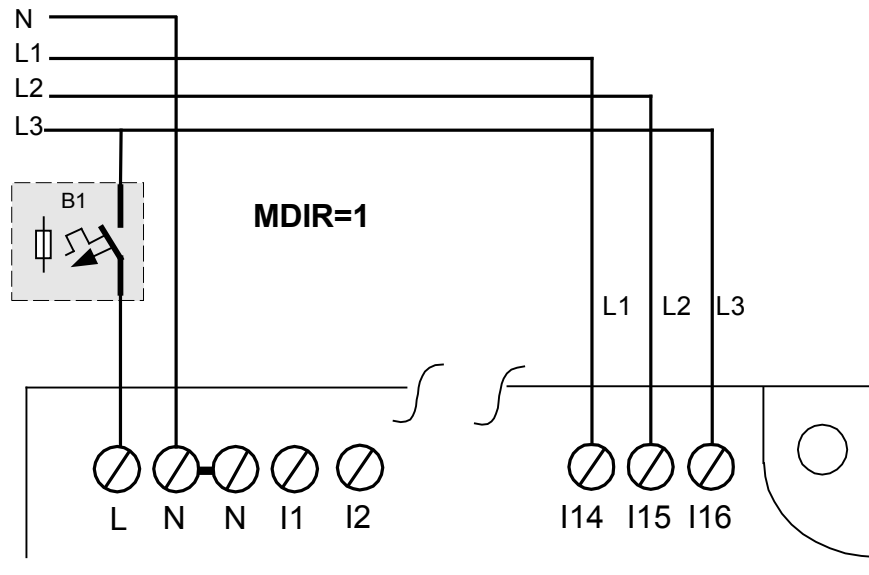

Fig. 4.6.2.1. Connection of a three phase network, where the MDIR marker takes the logical value of '1'.

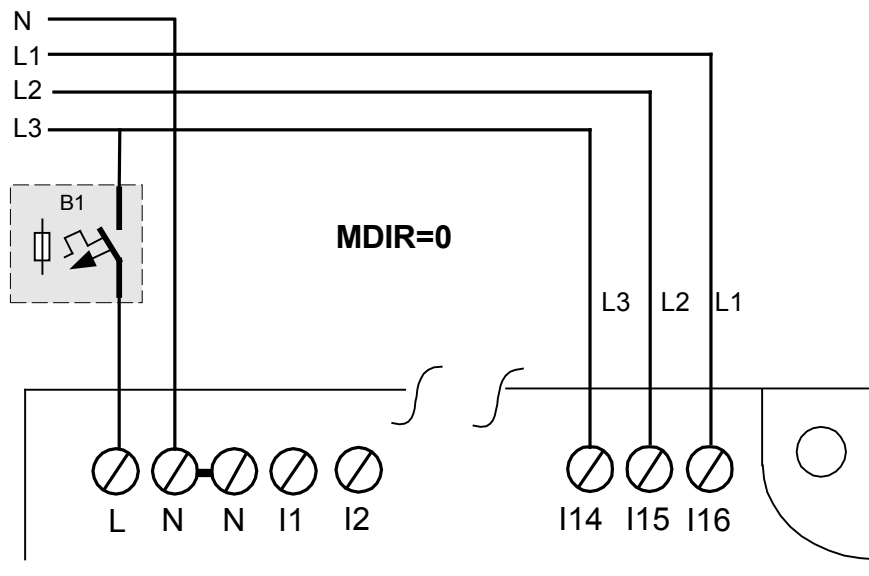

Fig. 4.6.2.2. Connection of a three phase network, where the MDIR marker takes the logical value of '0'.

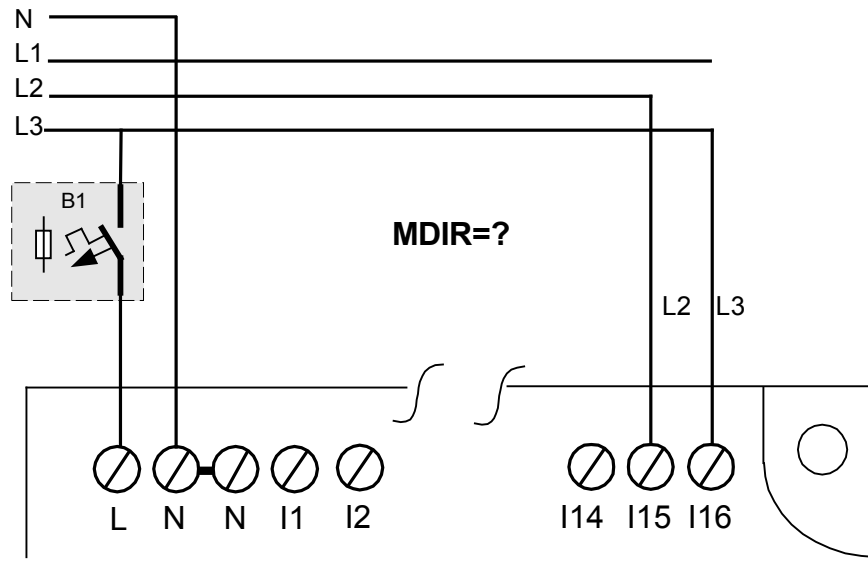

Fig.4.6.2.3. Connection of a three phase network, where the MDIR marker takes random values of '0' or '1'.

4.6.3. Text Marker

Text Markers are used for display information and Alarm's on LCD panel. They are used like a usual Markers "M".

SYMBOL: **MTn**, „n” being the Text Marker number n=1..8 NEED-..22-..

Configuration of MT it carry out in "Settings", where for appropriate MT we can set text. Fig. 4.6.3.1. show sample screen for MT1

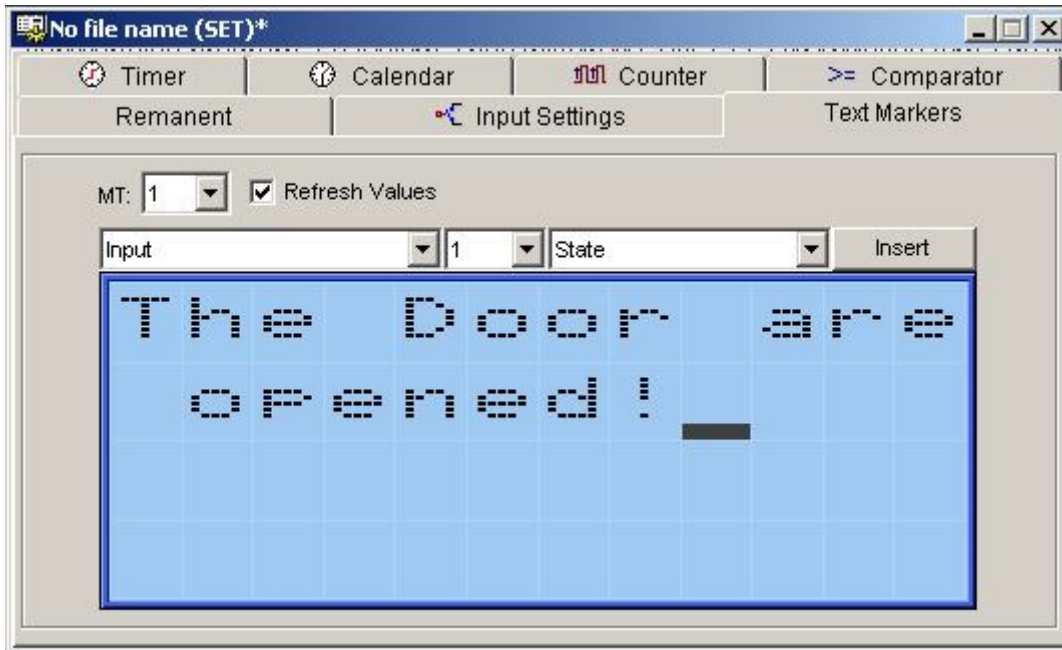

Fig. 4.6.3.1. Sample alarm screen for MT1.

Table 4.7. Time ranges of timers .

Time format	Range	Increment
s.ms (seconds.milliseconds)	0s.10ms - 99s.990ms	10ms
min.s (minutes.seconds)	0min.1s - 99min.59s	1s
h.min (hours.minutes)	0h.1min - 99h.59min	1min

Outputs

Timer output is set or reset depending on the time function selected (Timer type).

Timer outputs can be used in the program as markers, by replacing the letter M in the designation with the letter T.

4.7.1. Timer „Delayed activation” (ON-DELAYED).

Symbols of SD Timer .

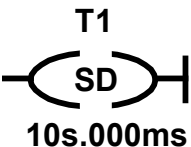
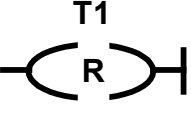
STL	LAD
L 10s SD T1	 <p>T1 10s.000ms</p>
R T1	 <p>T1</p>



Time function performed:

If leading edge is present at the Trigger input while the Reset input is inactive then, after a time period preset on the timer, the Timer output is activated to the state '1' – the Trigger input must remain in the high state. Should the Trigger input change its state to '0' the time counter is automatically reset and the output is cleared.

If the Reset input is set to '1', the Timer is reset at any point of its operation to stop time measurement. Output state returns to the original state ('0'). Time measurement is resumed only after the Reset signal is set to low and the positive edge is present at the Trigger input.

4.7.2. Timer “Delayed deactivation” (OFF-DELAYED)

Symbols of the SF Timer.

STL	LAD
L 10s SF T1	T1  10s.000ms
R T1	T1 

Time function performed:



If the Trigger input state is ‘1’ with ‘0’ state being present at the Reset input, then the output is active. If now the Trigger input goes to low state (‘0’ – trailing edge) then, after a time set on the Timer, the Timer output is deactivated – set to ‘0’.

Should the Trigger input change its state to ‘1’ the time counter is automatically reset and the output is set back to high state (‘1’).

If the Reset input is set to ‘1’, the Timer is reset to stop time measurement, the Timer output state changing to ‘0’. Time measurement is resumed only after the Reset signal is set to low (‘0’) and a negative triggering edge is present at the Trigger input.

4.7.3. Timer “Single pulse”

Symbols of the SE Timer.

STL	LAD
L 10s SE T1	T1  10s.000ms
R T1	T1 

Time function performed:

If the triggering signal (leading edge) appears at the Trigger input, the Reset input being inactive, then the system activates the output for the time set and returns to ‘0’ state afterwards – state of the Trigger at that time is of no importance (it can have the value of ‘0’).

Each positive edge at the Trigger input extends the pulse by another time set. Setting of the Reset input at any time point resets the Timer output state to '0'. Next triggering can occur after the Reset input is set to '0' and another leading edge appears at the Trigger input.

4.7.4. Timer "Pulses" (FLASHING)

Symbols of the SL Timer.

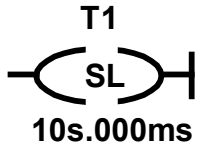
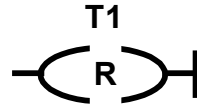
STL	LAD
L 10s SL T1	
R T1	

Time function performed:

The Timer acts as a square wave generator of pulse-width modulation of 50%. The system starts to generate pulses of the preset duration time when the Trigger input state is '1'.

Durations of '1' and '0' states are equal and the operating frequency for that Timer type is: $f=1/(2T)$, "T" being the preset time to be measured by the Timer.

Setting the Reset input state to high results in immediate setting of the output state to low. When the Trigger signal goes to low, the Timer output also goes to '0'.

The interdependence between the Trigger and Reset inputs and the Timer output are as follows:

- Once the state '1' is sent to the Trigger, the Reset input being at '0', the output first remains in the '0' state for the time period preset previously and then goes to '1', the cycle being repeated afterwards.
- If both Trigger and Reset are set to 'high' at the same time, then the output is '0'. Once the Reset goes to low state, the Trigger remaining at '1', the system activates the output to the time set and deactivates it afterwards, the cycle being repeated.

4.8. Counters

SYMBOL: **Cn** , “n” being the Counter number within the range of 1 to 8

LOGICAL STATES OF INPUTS: **CU, CD, RESET**:

‘0’ or ‘1’ depending on the function in the program.

LOGICAL STATES OF OUTPUT:

‘0’ or ‘1’ depending on the function in the program.

RANGE OF VALUES COUNTED:

0- 65535.

The counter counts the pulses that occur during the presence of the leading edge at that input which triggers the counting.

The logical structure of the Counter comprises inputs, output and the numerical value of pulses to be counted.

Counter inputs and outputs can be logically combined also via bit signals (I,Q,M).

Inputs

The inputs comprise:

- resetting input (RESET) – sets the Counter output to low state (‘0’) and stops pulse count, and sets the Counter to zero
- inputs triggering the count – CU,CD – signals sent to those inputs, leading edges, trigger the count-up or count-down, respectively. Thus, the same Counter can perform simultaneous count-up and count-down functions.

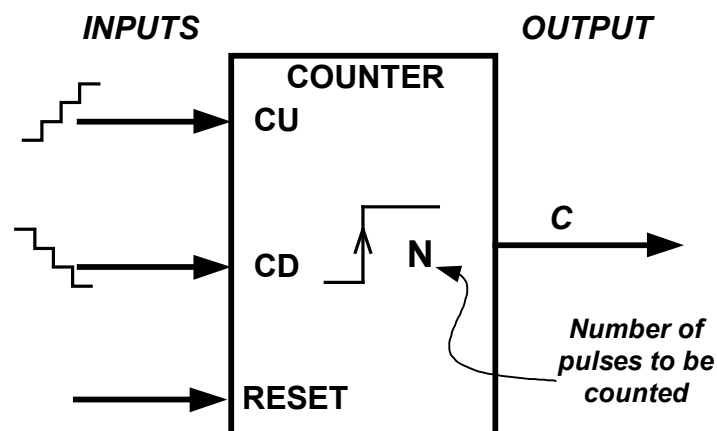

Fig. 4.8.1. Logical structure of the counter.

Number of pulses to be counted

Number of pulses to be counted, from the range of 0 to 65535, can be defined using loading instruction (STL) or settings file (“*.set”) of the relay for the LAD diagram.

Output

Counter output is set to high or reset (set to low) depending on the pulse Counter state.

Counter output state goes to ‘1’ if the below condition is true

- the current number of pulses counted \geq preset number to be counted.

Counter output state goes to ‘0’ if the below condition is true

- the current number of pulses counted $<$ preset number to be counted.

Occurrence of a positive edge at the CU input results in increasing the number counted by 1 while the positive edge at the CD input reduces that value by 1. The Counter outputs can be used in the program as Markers, the letter M being replaced in the designation by the letter "C".

Symbols of Counter

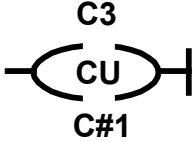
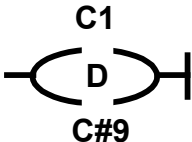
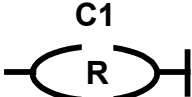
STL	LAD
L C#3 CU C1	
L C#9 CD C1	
R C1	

Pulse count up:

- The Counter counts the pulses that occur at the CU input.
- Counting is performed in ascending order. If the number of pulses counted is higher than or equal to the preset number of pulses then the Counter output state goes to '1'. This state remains unchanged until high state occurs at the Reset input, which causes both the output and the current counter value to be reset.
- The Counter can never overflow; if the number of the pulses counted reaches 65535, the Counter stops counting up.

Pulse count-down:

- The Counter counts the pulses that occur at the CD input.
- Counting is performed in descending order. If the number of pulses counted is higher than or equal to the preset number of pulses then the Counter output state goes to '1'. This state remains unchanged until high state occurs at the Reset input, which causes both the output and the current counter value to be reset.
- The Counter can never overflow; if the number of the pulses counted reaches 0, the Counter stops counting down.



In the NEED-12DC-11-16-8, NEED-24DC-11-16-8, NEED-12DC-22-.. and NEED-24DC-22-.. versions, in addition to the above-mentioned 8 Counters, there is also an HC Fast Counter, which counts impulses with maximum frequency of 20kHz. HC is a hardware counter and counts impulses appearing at the **I11** input for NEED-12DC-11-16-8, NEED-24DC-11-16-8, NEED-12DC-22-16-8 and NEED-24DC-22-16-8 and at the **I4** input for NEED-12DC-22-08-4 and NEED-24DC-22-08-4. Apart from the count direction function, the CU, CD inputs also function as the Fast Counter

activation in that case.

The Fast Counter can operate in the frequency mode – it counts impulses appearing at the I11 or I4 input within 1s.

Once the maximum value of 65535 is reached, the Fast Counter starts counting from 0 after the Reset instruction is executed.

The Fast Counter can run in the frequency mode – it counts pulses appearing at the I11 input during 1second.

The Fast Counter, after reaching the maximum value - 65535, starts counting from zero after performing the reset function.



For the NEED-230VAC-...-16-8 version the *Fast Counter* HC measures the power supply network frequency (50Hz or 60Hz) – for the frequency mode. Whereas in the counter mode it counts pulses of the power supply network every 20ms (for the 50Hz frequency of the power supply network) or 16,6ms (for the 60Hz power supply network)

4.9. Clocks

SYMBOL: **H<n>** , “n” being the Clock number: n=1..4, NEED-...x1-..
n=1..8, NEED-...22-..

LOGICAL STATES OF THE OUTPUT:

‘0’ or ‘1’ depending on the function in the program.

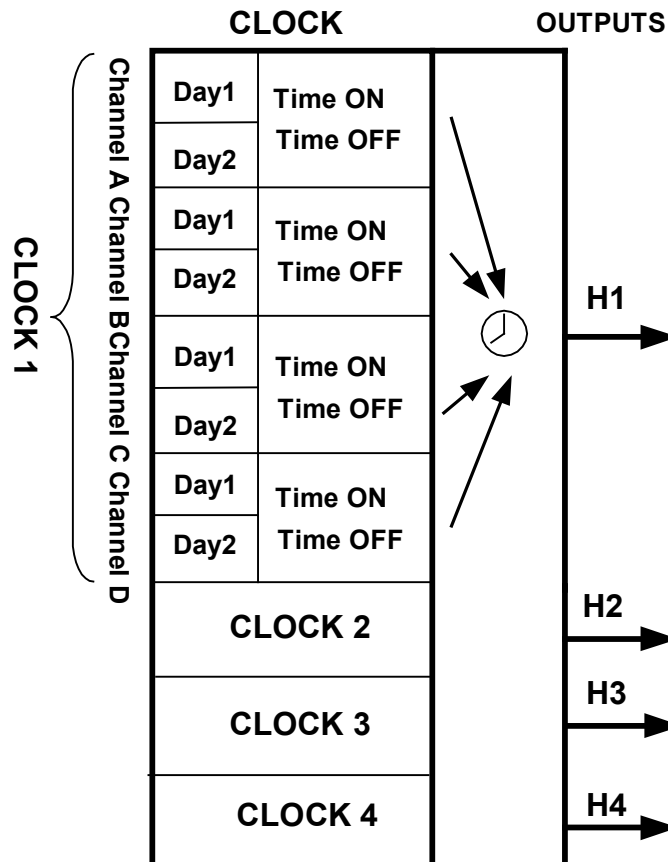

Fig. 4.9.1. Logical structure of the Clock – NEED-...x1-..

When programming the relay, one-week H1, H2, H3 and H4 for NEED-..-x1-.. or H1 – H8 for NEED-..-22-.. control clocks can be used.

Each Clock has four channels A,B,C and D. The Clock output is common for the four channels. Figure 4.9.1 illustrates the logical structure of the Clocks.

4.9.1. Clock operation

Clock operation in the programmable relay can be compared to the operation of a device, the schematic diagram of which is presented in Fig. 4.9.2. The clock is turned on using „ON” switches and turned off using „OFF” switches. Clock setting is performed using “PC Need” program.

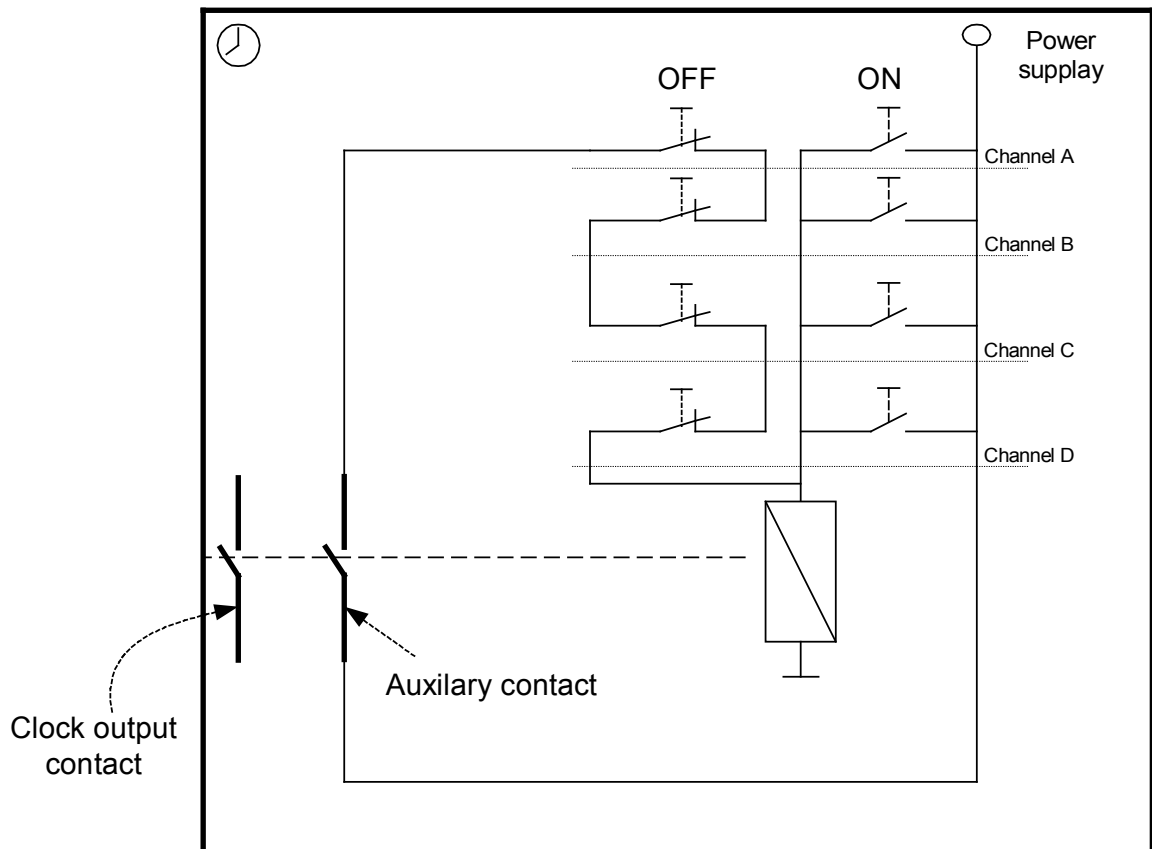

Fig. 4.9.2. Schematic diagram of a single clock.

Example 1

Fig. 4.9.3. shows a sample configuration window for the Clock 1.

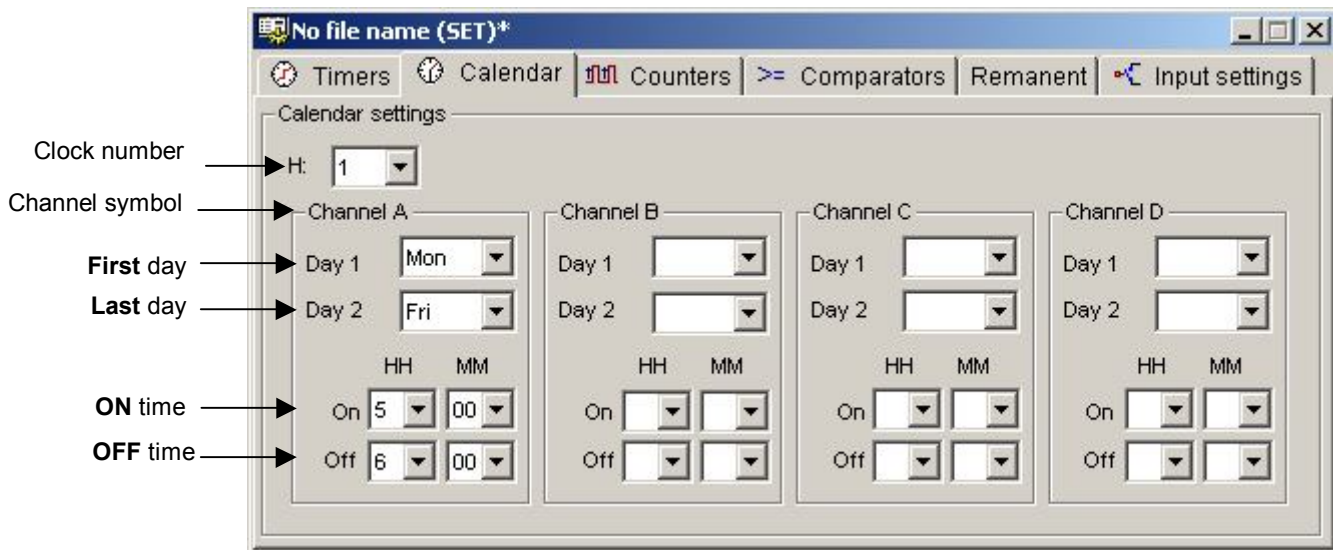

Fig. 4.9.3. Sample Clock 1 configuration window.

- First day** – first day in a one-week schedule when the clock is turned on /off (Monday in the above example).
- Last day** – last day in a one-week schedule when the clock is turned on/off (Friday in the above example).
- ON time** – time of turning on the clock output (range: from 0.00 to 23.59) (5.00 in the above example).
- OFF time** – time of turning off the clock output (range: from 0.00 to 23.59) (6.00 in the above example).

In the configuration presented above Clock 1 will set its output state to high each day, Monday through Friday, between 5 a.m. (ON time) and 6 a.m. (OFF time). This situation is presented in Fig. 4.9.4.

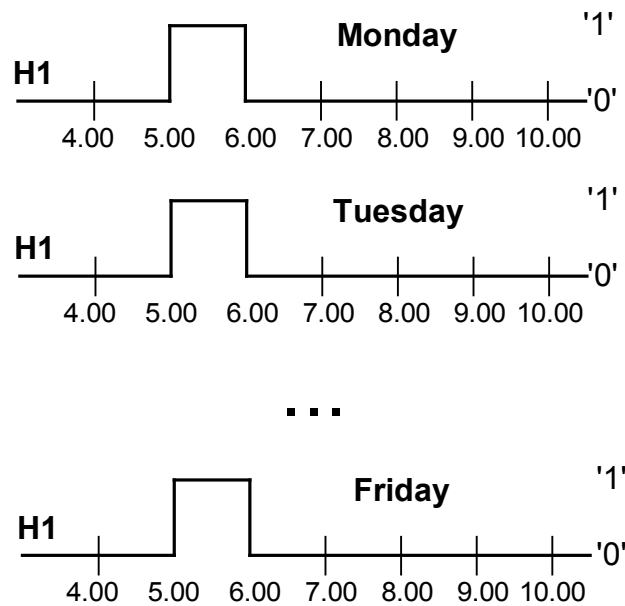

Fig.4.9.4. Clock 1 operation in the configuration presented in Fig. 4.9.3.

Example 2

Fig. 4.9.5. shows a sample configuration window for the Clock 1.

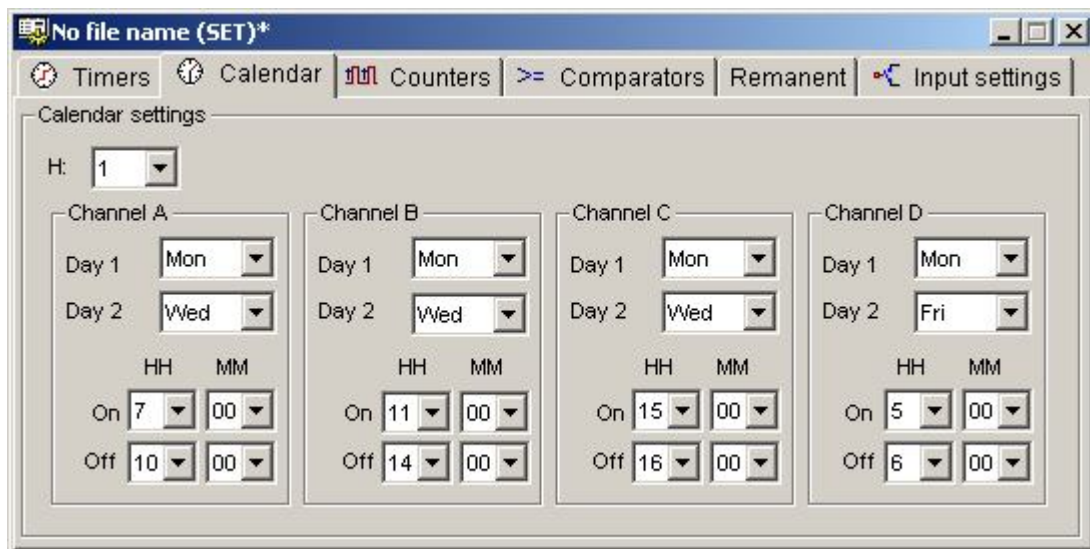

Fig. 4.9.5. Clock 1 sample configuration window.

In the configuration presented above Clock 1 will set its output state to high on each day, Monday through Wednesday, between 7 a.m. (ON time) and 10 a.m. (OFF time) and between 11 a.m. (ON time) and 2 p.m. (OFF time) and between 3 p.m. (ON time) and 4 p.m. (OFF time). Additionally the Clock 1 output will be set Monday through Friday between 5 a.m. and 6 a.m. This situation is presented in Fig. 4.9.6.

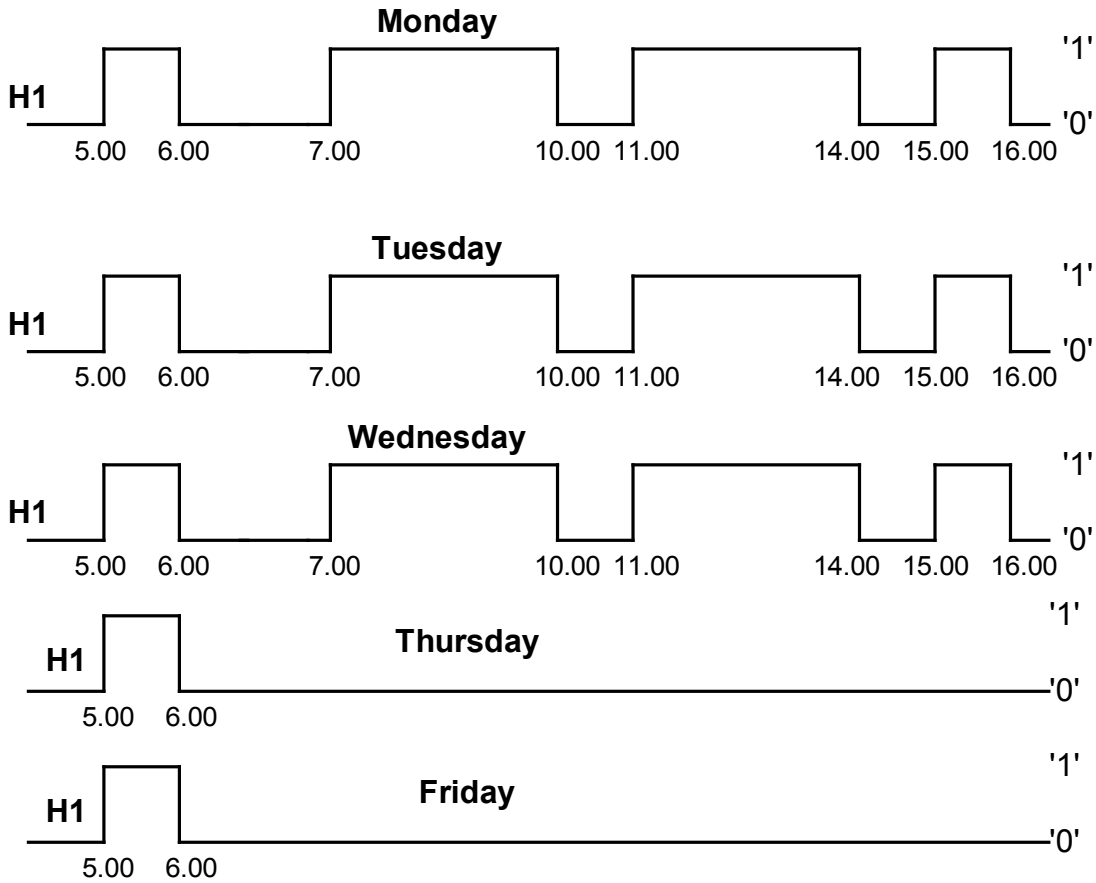

Fig. 4.9.6. Clock 1 operation in the configuration presented in Fig.4.9.5.

Example 3

Fig. 4.9.7. shows a sample configuration window for Clock 2.

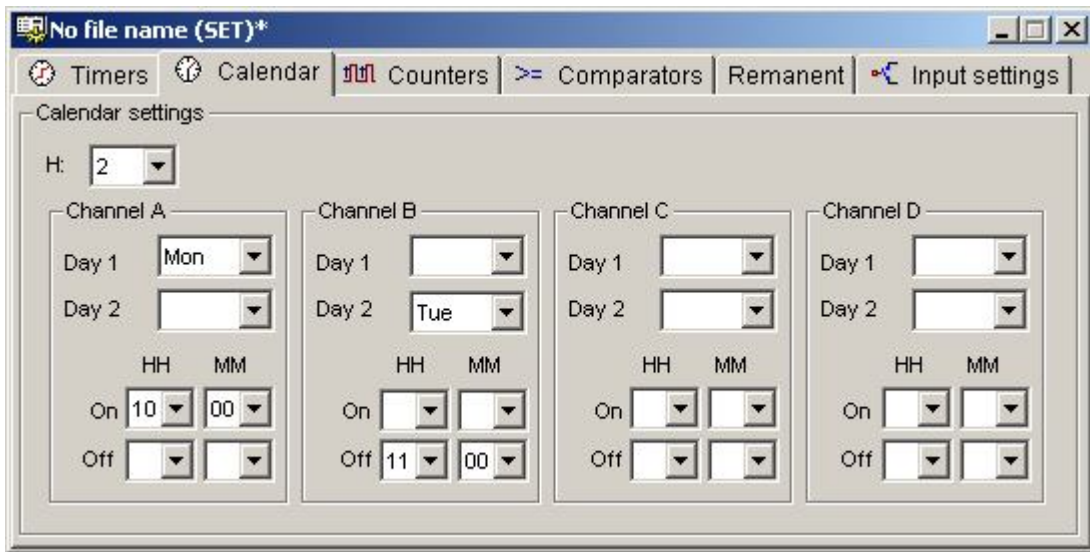

Fig.4.9.7. Clock 2 sample configuration window.

In the configuration presented above, Clock 2 will set its output state to high each Monday at 10 a.m. (turn-on time) and will turn off each Tuesday at 11 a.m. If this control is to be applied to a greater number of days, the fields „ON time” or „ OFF time must be left blank for appropriate channels. Clock 2 operation diagram is shown in Fig. 4.9.8.

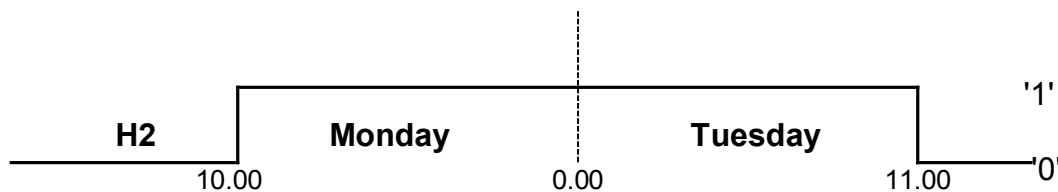

Fig. 4.9.8. Clock 2 operation in the configuration presented in Fig. 4.9.7.

Identical Clock 2 operation can be achieved if the configuration is made as shown in Fig. 4.9.9.

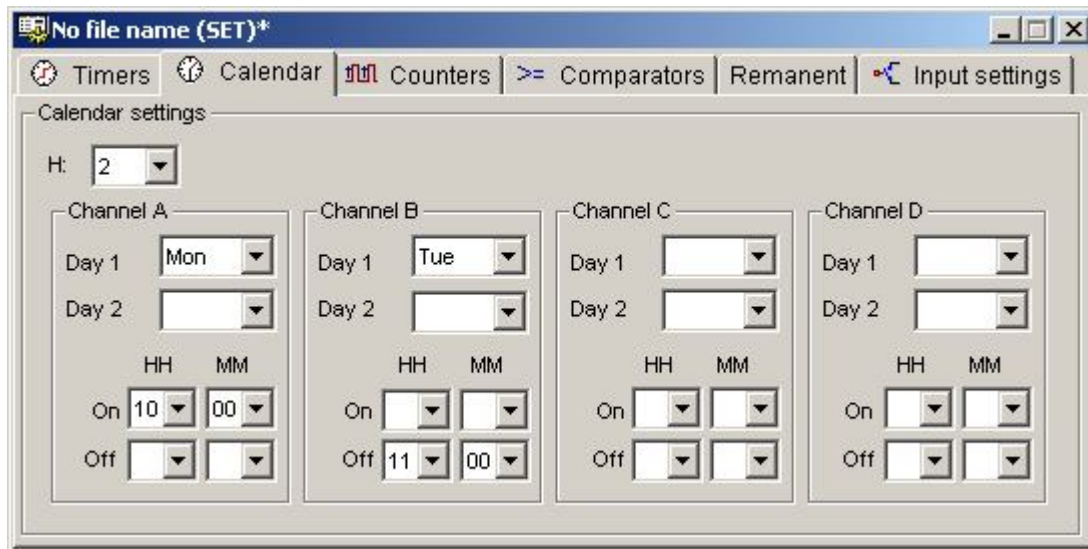

Fig. 4.9.9. Clock 2 sample configuration window.

Example 4

If the ON time is later than the OFF time the clock output is turned off on the following day - configuration according to Fig. 4.9.10.

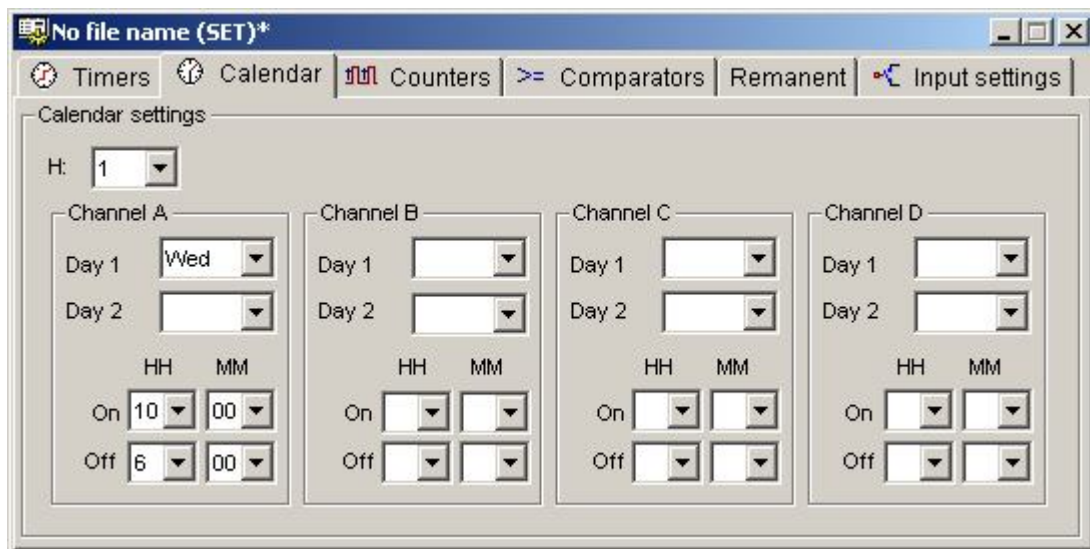

Fig. 4.9.10. Clock 1 sample configuration window.

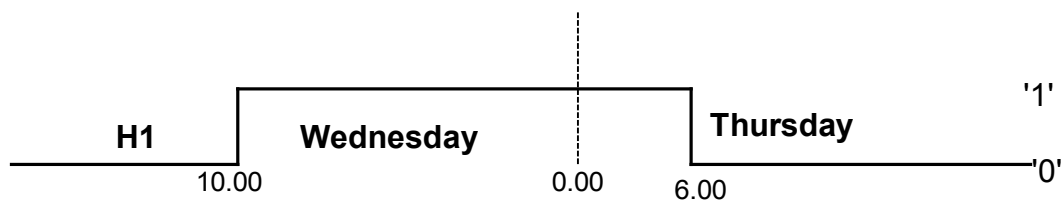

Fig. 4.9.11. Clock 1 operation in the configuration presented in Fig. 4.9.10.



If the OFF time is earlier than the ON time NEED programmable relay turns off the output of the Clock being used, on the following day.

Example 5

Turning the clock output on for 24 hours.

In order to achieve a 24-hour operation the Clock 3 must be configured as shown in Fig. 4.9.12.

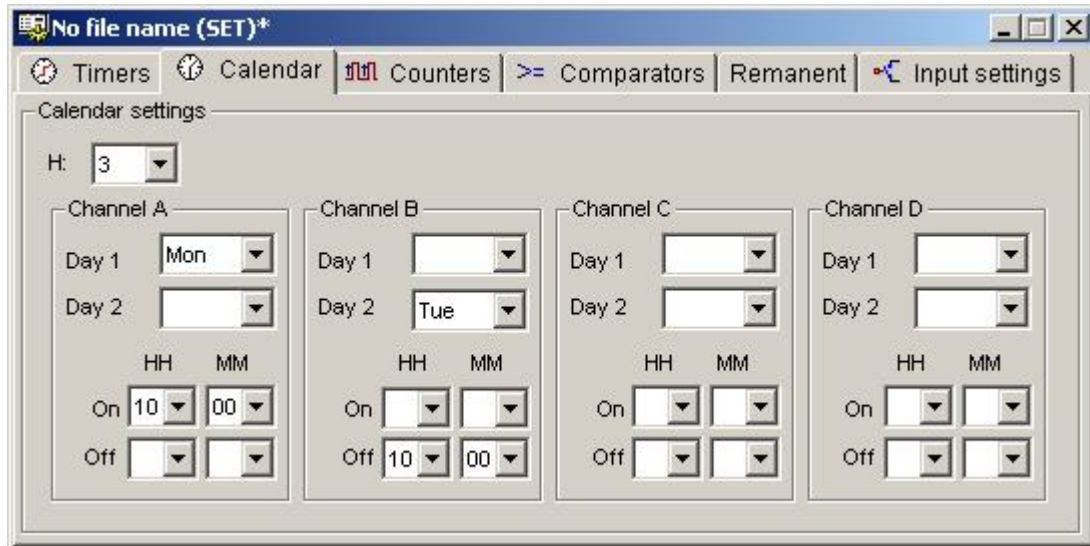

Fig. 4.9.12. 24-hour operation sample configuration window.

Example 6

It must be remembered that the clock output state depends on the states of all four channels. Let's analyse the configuration of Clock 4 shown in Fig.4.9.13.

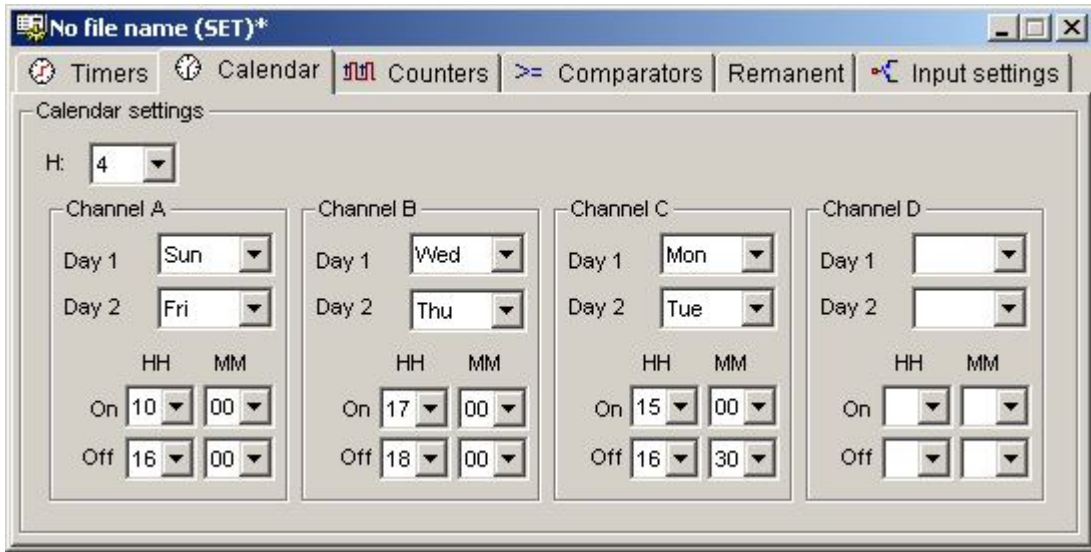

Fig.4.9.13. Clock 4 sample configuration window.

Please note that the times preset in channels A and C are the same – Fig.4.9.14.

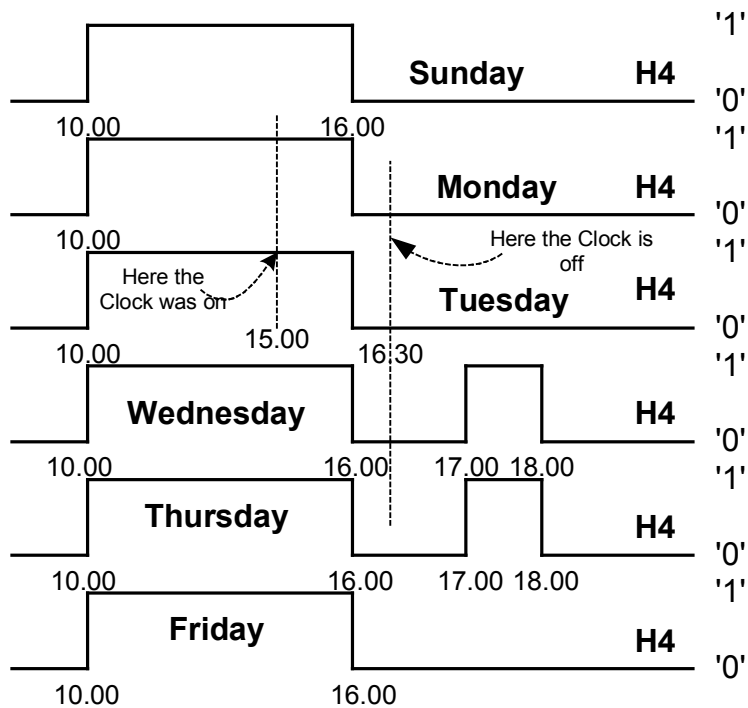

Fig. 4.9.14. Operation of Clock 4 in the configuration shown in Fig. 4.9.13.

As the clock time settings may overlap it must be always taken into account that the clock output turns on that channel the turn-on time of which is earlier and it turns off the channel the turn-off time of which is earlier.

Example 7

Let's analyse the configuration of Clock 4 shown in Fig.4.9.15.

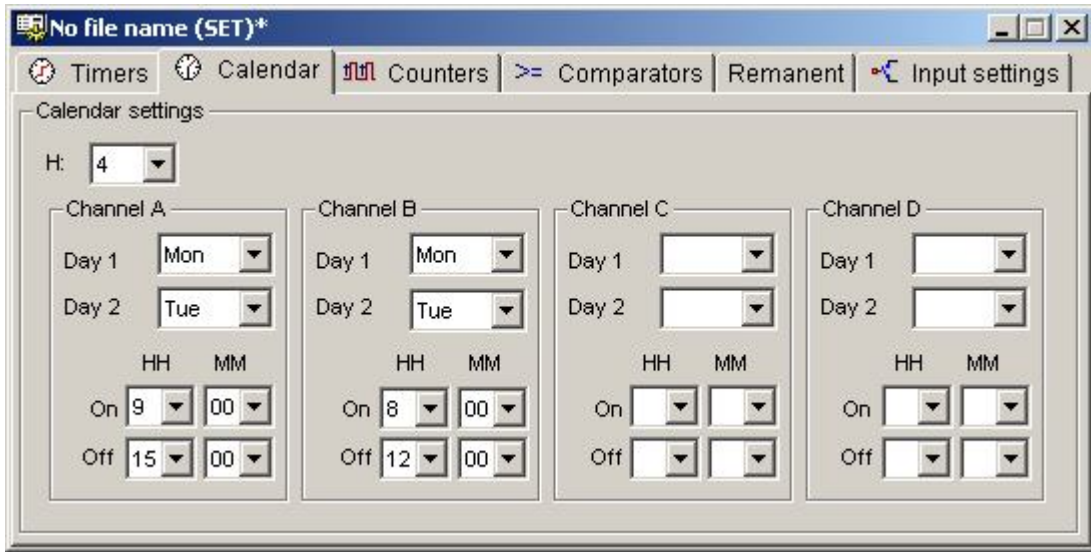

Fig. 4.9.15. Clock 4 sample configuration window.

The clock will turn on its output on Monday and Tuesday at 8 a.m. and will turn it off at 12 noon (and not 3 p.m. ! – “first on - first off” rule is used). Clock 4 operation diagram is presented in Fig. 4.9.16..

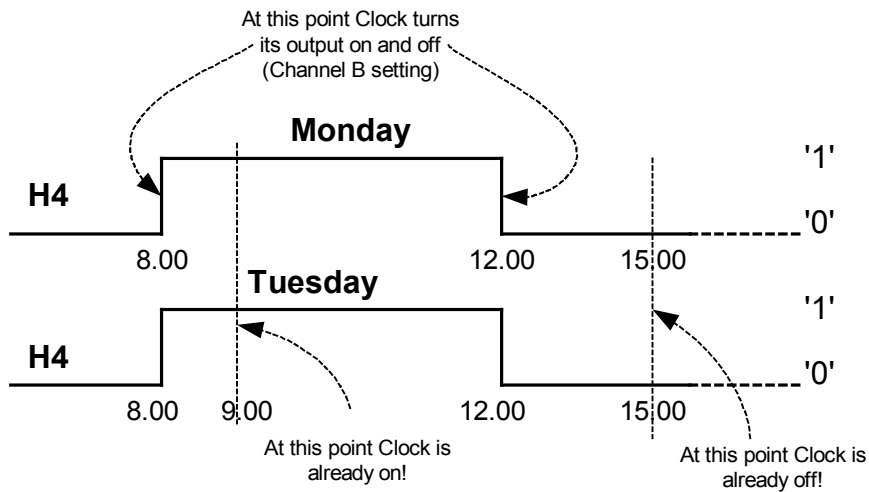

Fig. 4.9.16. Operation of Clock 4 in the configuration shown in Fig.4.9.15.

Example 8

Figure 4.9.17. shows the configuration of Clock 1. If the power is turned on between 10 a.m. and 12 noon, the relay output contacts will be open but the time will be still monitored. On return of the supply voltage at 12 noon the Clock H1 output state will be high – according to H1 configuration. This situation is illustrated in Fig. 4.9.18.

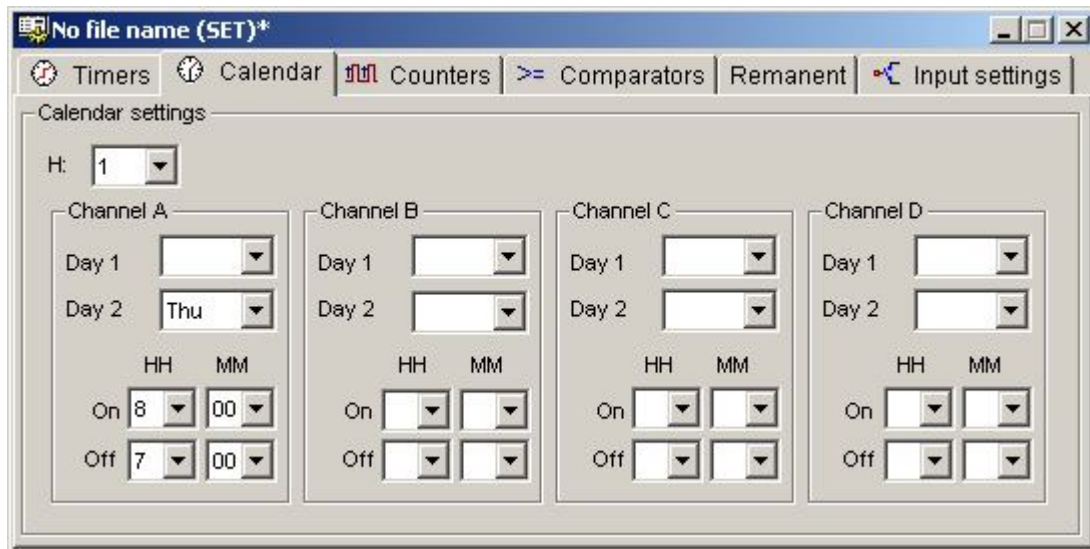

Fig. 4.9.17. Clock 1 sample configuration window .

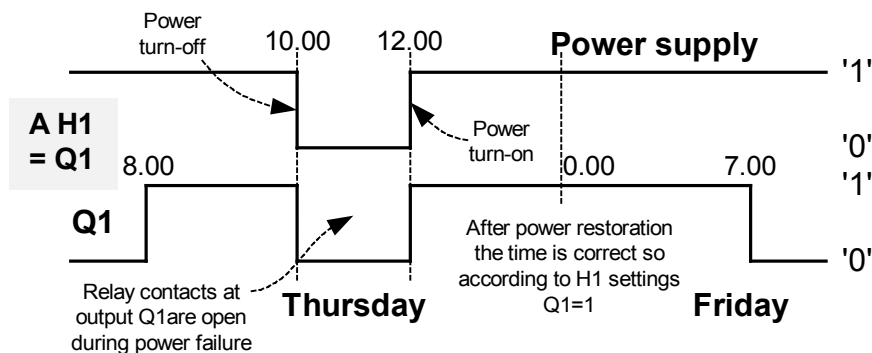

Fig. 4.9.18. Operation of Clock 1 in the configuration shown in Fig.4.9.17.



In case of power failure, time is still measured by the relay however the contacts of the output relays do not close. Clock back up during power supply is 64 hours (at 25°C).

4.9.2. Remarks concerning Clock configuration

4.9.2.1 One blank field – 3 filled fields (for 1 channel)

1. All fields filled, “ON “ field blank

Example:

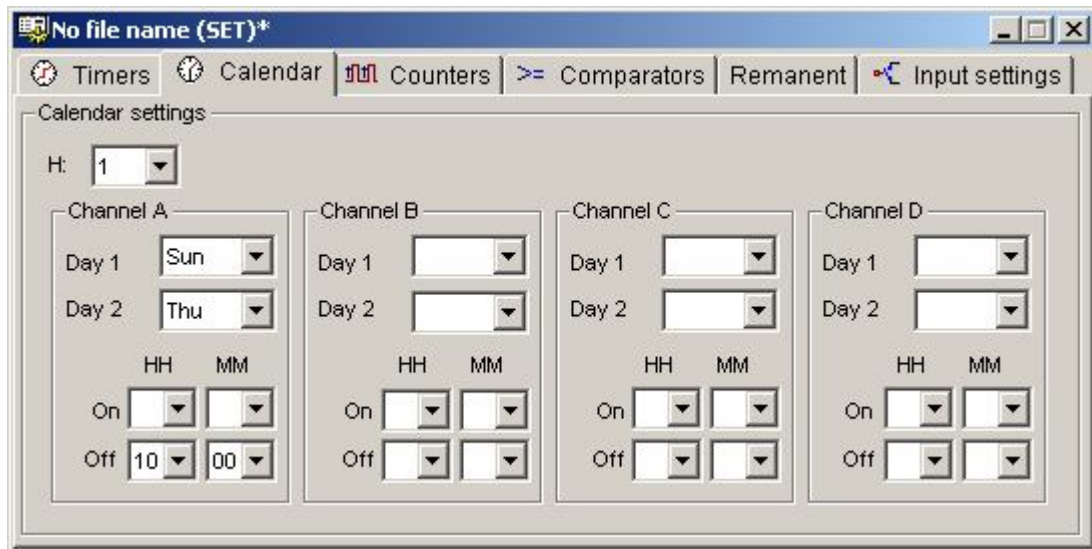

Fig. 4.9.2.1.1. Sample Clock configuration – “ON” field blank.

The Clock will turn its output on from Sunday to Tuesday at 10 a.m.

2. All fields filled, “OFF” field blank

Example:

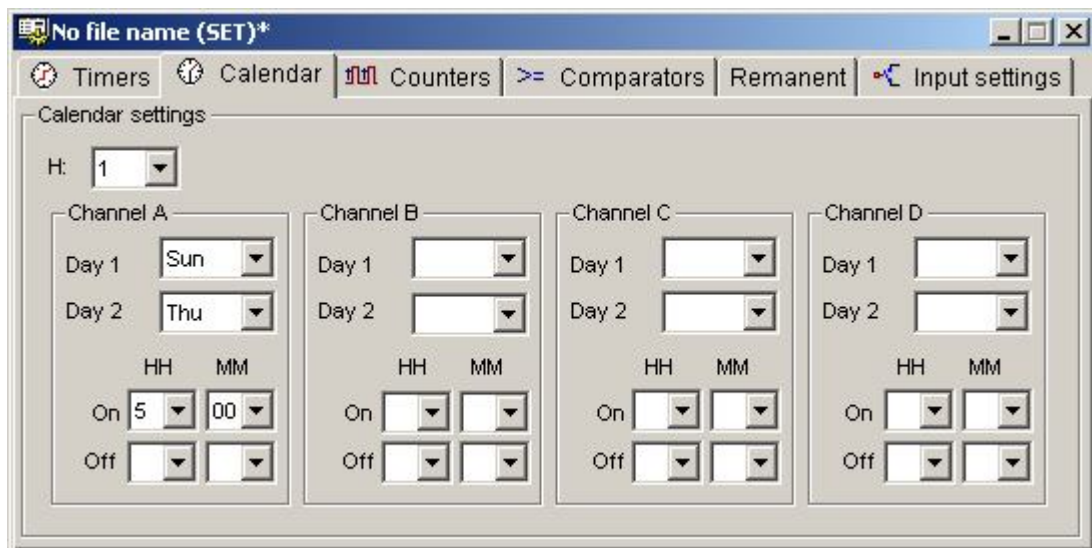

Fig. 4.9.2.1.2. Sample Clock configuration – 3 fields filled.



From Sunday to Tuesday the Clock will turn its output on at 5.00 a.m. If only the “ON” time is set, the Clock will remain on all the time.

3. All fields filled, “Day 1” field blank

Example:

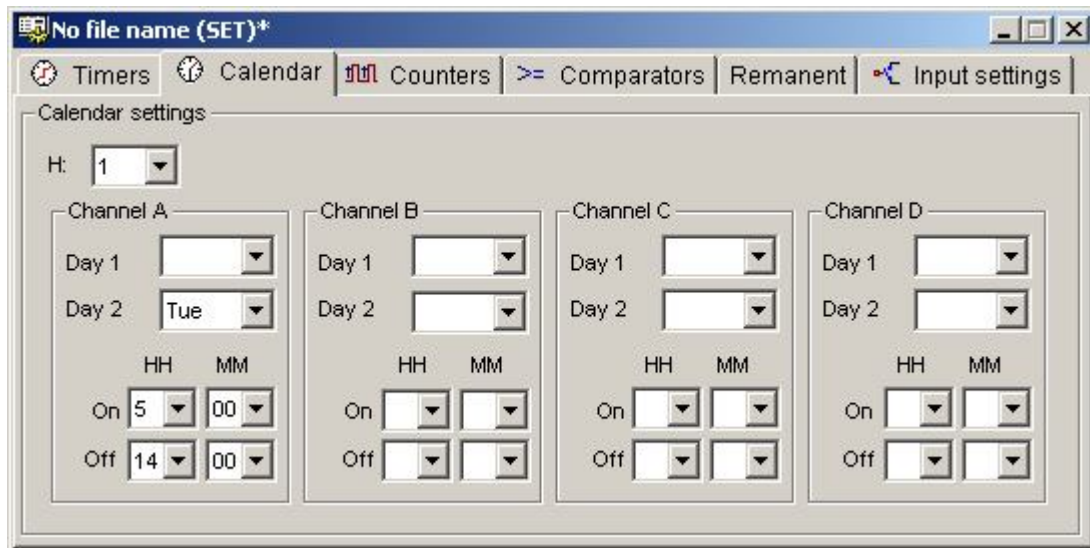

Fig. 4.9.2.1.3. Sample Clock configuration – “Day 1” field blank.

The Clock will enable its output only on Tuesdays at 5.00 a.m. and will disable it only on Tuesdays at 2 p.m.

4. All fields filled, “Day 2” field blank.

Example:

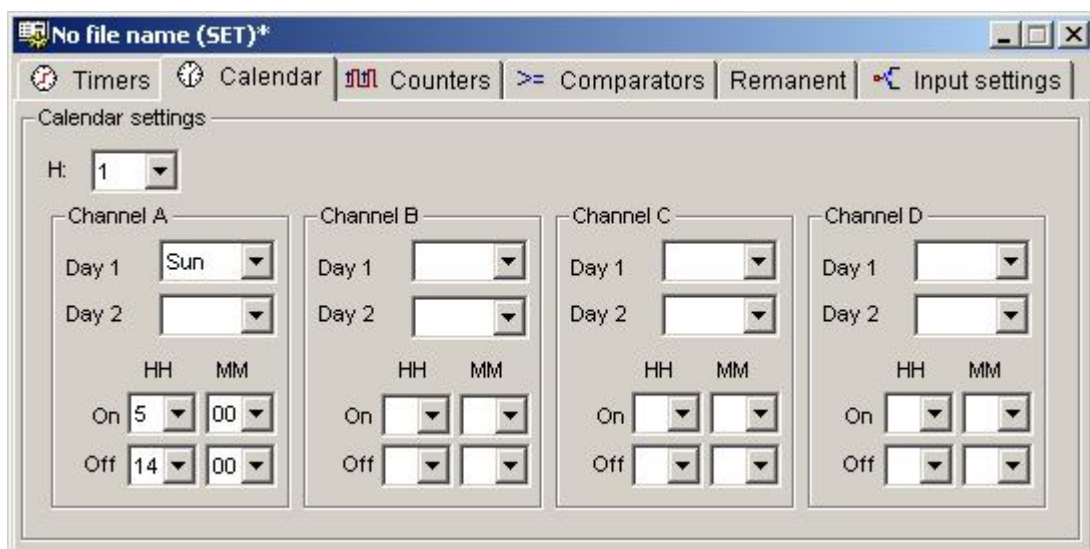

Fig. 4.9.2.1.4. Sample Clock configuration – “Day 2” field blank.

The Clock will enable its output only on Sunday at 5.00 a.m. and will disable it only on

Sunday at 2 p.m.

4.9.2.2. Two fields blank – 2 fields filled (for one channel)/

1. “ON” and “OFF” fields blank

Example:

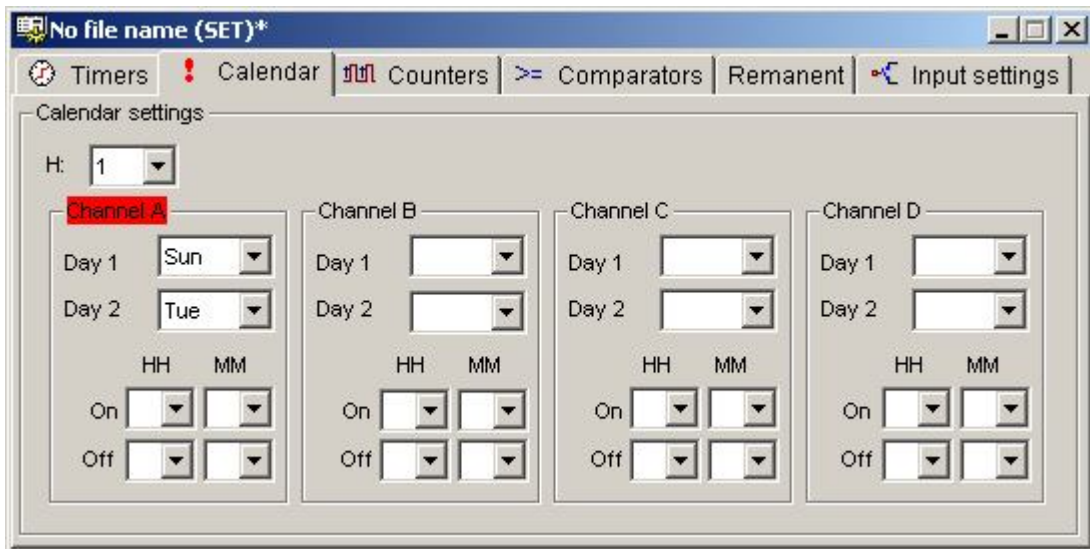

Fig. 4.9.2.2.1. Sample Clock configuration – “ON” and “OFF” fields blank.

The Clock is not operating – invalid setting which may not be sent to the relay.

2. “Day 1” and “Day 2” fields blank

Example:

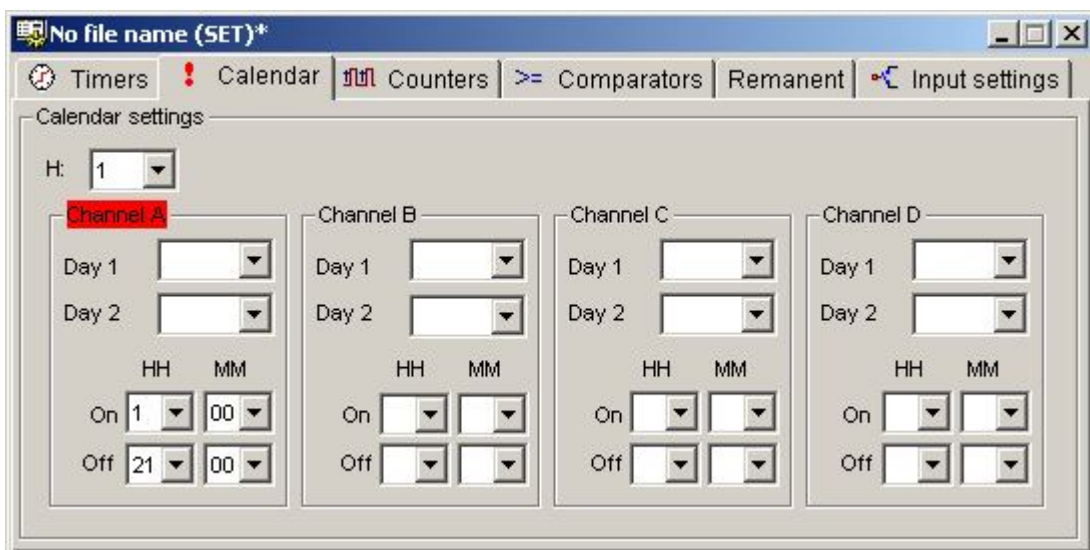

Fig. 4.9.2.2.2. Sample Clock configuration – “Day 1” and “Day 2” fields blank.

The Clock is not operating – invalid setting which may not be sent to the relay.

4.9.2.3. Three fields blank (for one channel)

The Clock is not operating – invalid setting which may not be sent to the relay.

4.10. Real time clock,

The *real time clock* makes it possible to set the time, date and time zone according to which the summer/winter time change takes place in the NEED-..-16-8 relay, NEED-..22-... The settings for the *Real Time Clock* are made through the PCNeed program. Fig. 4.10.1. shows the settings dialog box.



Fig. 4.10.1. The Real Time Clock Settings Dialog Box.

The real time clock supports the following time zones:

- EU 1:00 – The zone where the change to summer time takes place on the last Sunday of March from 1:00 to 2:00 a.m., and the change to winter time - on the last Sunday of October from 2:00 to 1:00 a.m.
- EU 2:00 – The zone where the change to summer time takes place on the last Sunday of March from 2:00 to 3:00 a.m., and the change to winter time - on the last Sunday of October from 3:00 to 2:00 a.m.
- EU 3:00 – The zone where the change to summer time takes place on the last Sunday of March from 3:00 to 4:00 a.m., and the change to winter time - on the last Sunday of October from 4:00 to 3:00 a.m.
- RU – The zone where the change to summer time takes place on the last Sunday of March from 2:00 to 3:00 a.m., and the change to winter time - on the last Sunday of October from 3:00 to 2:00 a.m.
- US – The zone where the change to summer time takes place on the 2nd Sunday of March from 2:00 to 3:00 a.m., and the change to winter time - on the first Sunday of November from 3:00 to 2:00 a.m.

4.11. Comparator – analogue inputs

SYMBOL: **An**, where n – is the comparator number: n=1..8, NEED-...x1-08-..
 n=1..12, NEED-...-11-16-..
 n=1..16, NEED-...-22-..

LOGICAL STATES OF INPUT:

'0' or '1' depending on analogue voltage values and the programmable relay configuration settings.

Symbols of Comparator.

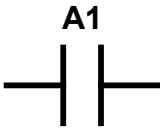
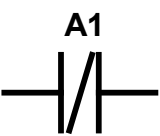
STL	LAD
A A1 or O A1 or X A1	 A1
AN A1 or ON A1 or XN A1	 A1

The programmable relay system is equipped with two (NEED-...-08-4) or three (NEED-...-16-8) analog inputs. Fig. 4.11.1. shows the logical structure of the *Comparators* in the NEED-...-01-08-4 relay.

Analog signals can be compared in the *Comparator* with each other, with a predefined standard value and with the set-point of an external potentiometer. The result of the comparison defines the state of the *Comparator's* outputs. The outputs are always set to the high state ('1'), if the condition of the comparison is satisfied. Available comparisons are shown in table 4.11.1 and 4.11.12.

Table 4.11.1. Possible configurations of comparator comparisons for NEED... – 08-4.

No.	Comparison type
1.	$I7 \geq \text{Standard value}$
2.	$I7 \leq \text{Standard value}$
3.	$I8 \geq \text{Standard value}$
4.	$I8 \leq \text{Standard value}$
5.	$I7 \geq \text{Potentiometer}$
6.	$I7 \leq \text{Potentiometer}$
7.	$I8 \geq \text{Potentiometer}$
8.	$I8 \leq \text{Potentiometer}$
9.	$I7 \geq I8$
10.	$I7 \leq I8$

Table 4.11.2. Possible configurations of comparator comparisons for NEED... – 16-8.

No.	Comparison type
1.	I14 ≥ Standard value
2.	I4 ≤ Standard value
3.	I15 ≥ Standard value
4.	I15 ≤ Standard value
5.	I16 ≥ Standard value
6.	I16 ≤ Standard value
7.	I14 ≥ Potentiometer
8.	I14 ≤ Potentiometer
9.	I15 ≥ Potentiometer
10.	I15 ≤ Potentiometer
11.	I16 ≥ Potentiometer
12.	I16 ≤ Potentiometer
13.	I14 ≥ I15
14.	I14 ≤ I15
15.	I14 ≥ I16
16.	I14 ≤ I16
17.	I15 ≥ I16
18.	I15 ≤ I16
19.*	ASYM ≥ Standard value
20.*	ASYM ≤ Standard value
21.*	ASYM ≥ Potentiometer
22.*	ASYM ≤ Potentiometer

* - possible only for NEED-230AC-01-16-8



ASYM is the phase asymmetry index (only for NEED-230AC-x1-16-8). Shows the rms values of the total of L1, L2, L3 phases. ASYM takes the value of 0V for correct levels of L1, L2, L3 phases. When asymmetry is present (the voltage level of any phase is different from the rated. Value ASYM takes the value greater than 0V.



ASYM with the MDIR *Marker* and the *Comparators* make it possible to use the NEED-230AC-...-16-8 device as a supervisory relay, controlling asymmetry, order and voltage levels of the L1, L2, L3 phases.

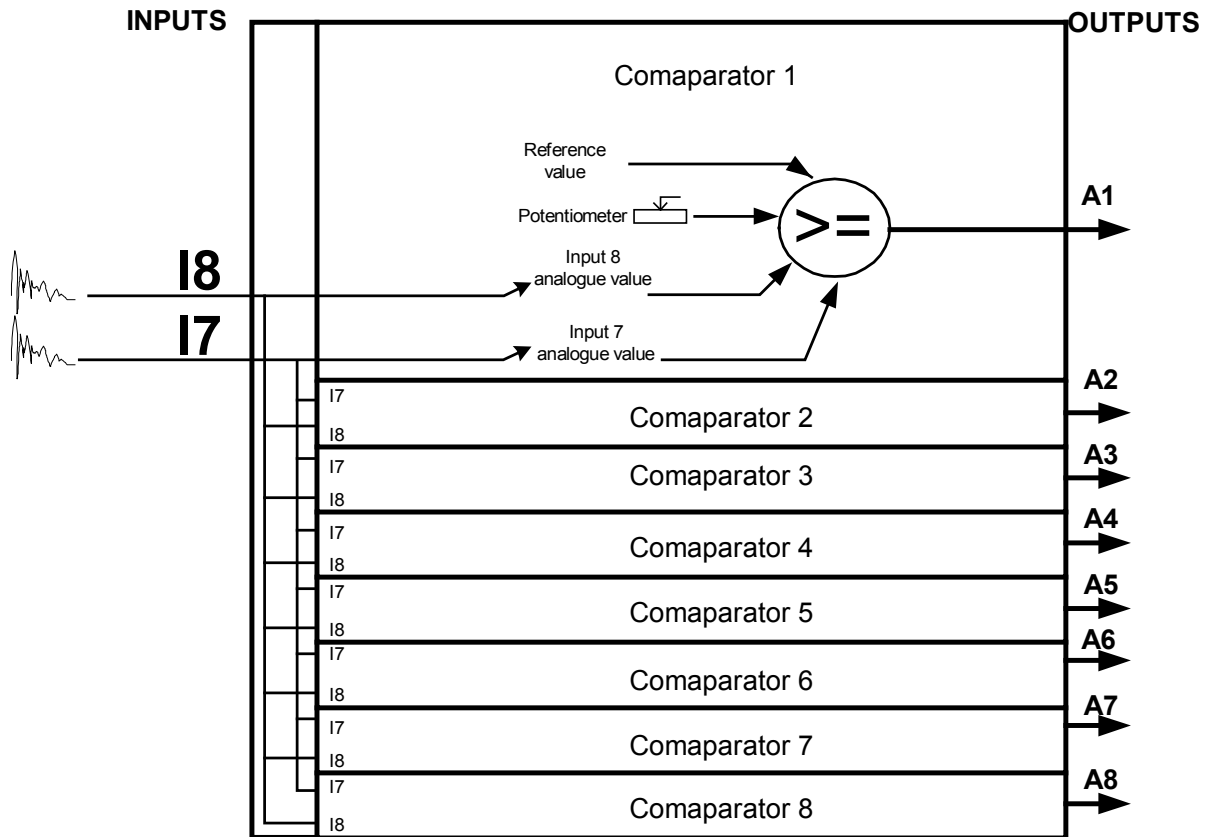

Fig. 4.10.1. Logical structure of Comparator

The following are used for comparison:

1. Model value (defined when configuring the PC Need program) of the following range:
 0 – 255V for NEED-230AC-..
 0 – 25.5V and 0 – 12.75V for NEED-24DC-...-16-8., NEED-12DC-...-16-8.
2. Potentiometer (control range 1 – 255) – available at the front relay board.
3. Voltage values of analog inputs.

Table 4.11.3 shows the ranges taken by the standard value.

Table 4.11.3. Possible standard value ranges for the comparator comparisons.

Type	Standard value range
NEED-230AC-..	0 – 255V
NEED-12DC-..	0 – 25.5V
NEED-24DC-..	0 – 25.5V
NEED-12DC-...16-8	0 – 12.75V
NEED-24DC-...16-8	0 – 12.75V

An example of the A6 *comparator* configuration for comparison with the standard value is shown in fig. 4.11.3.

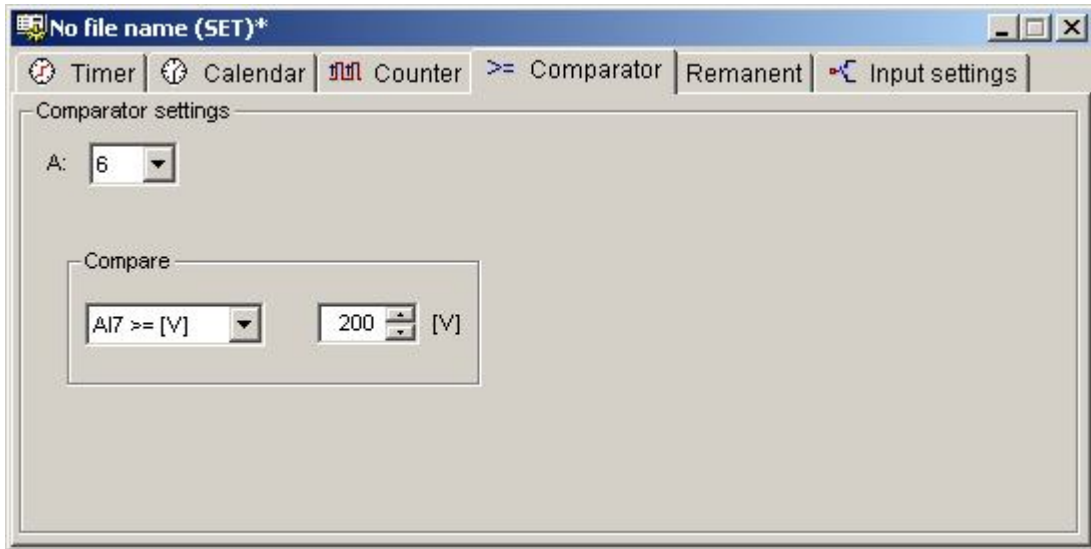

Fig. 4.11.3. An example of the A6 comparator configuration for comparison with the standard value.

The A6 Comparator output is set to '1', when the voltage value at the I7 input is equal to, or greater than 200V.

Table 4.11.4 shows the Potentiometer range for comparator comparisons.

Table 4.11.4. Possible standard value ranges for the comparator comparisons.

Type	Standard value range
NEED-230AC-..	1 - 255
NEED-12DC-..	
NEED-24DC-..	

An example of the A7 comparator configuration for comparison with the Potentiometer is shown in fig. 4.11.4.

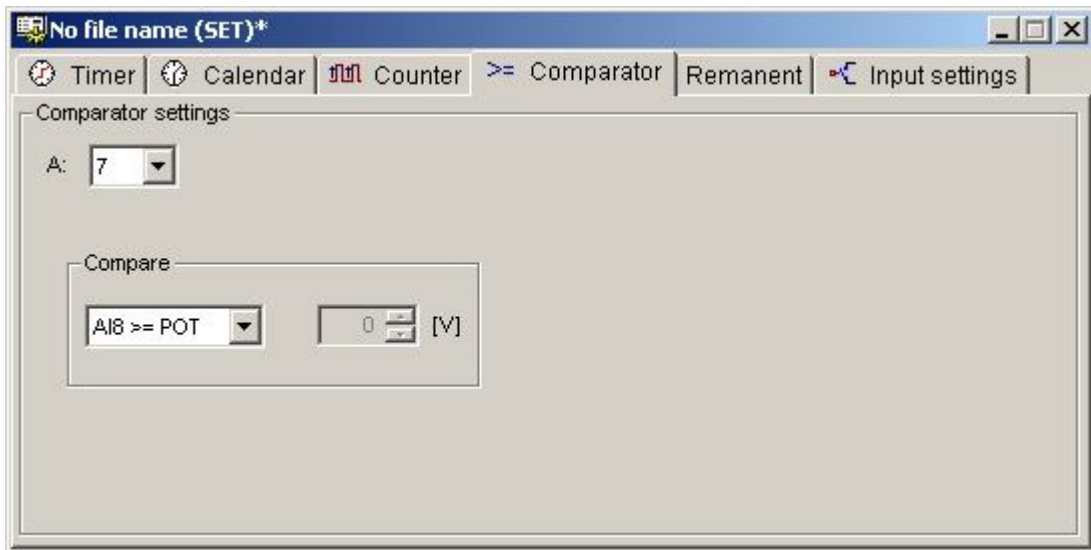

Fig. 4.14.4. An example of the A7 comparator configuration for comparison with the Potentiometer.

The A7 Comparator output is set to '1', when the voltage value at the I8 input is equal to, or greater than the value set with the Potentiometer.



For NEED-24DC-..., NEED-12DC-.. the potentiometer takes values from 0.1 to 25.5. It must be pointed out that in the Variable view window POT takes values from 1 – 255, but for the comparator comparisons values from 1/10 (i.e. 0.1) to 255/10 (i.e. 25.5) are used!

For example for the “A17<=POT” relationship at the voltage of A17=5V, the comparator output will be set to the high state, e.g. to the variable setting of POT=50 (i.e. 50/10) in Variable view.

Therefore for the potentiometer to be set correctly for NEED-24DC-..., NEED-12DC-.. relays, the POT variable value shown in the Variable view must always be divided by 10.

Table 4.11.5. shows the ranges of analog inputs in the NEED relay.

Table 4.11.5. Ranges of analog inputs in the NEED relay

Type	Analog input type	Scope	Resolution
NEED-230AC-..	Voltage	0 – 255V	1V
NEED-12DC-..	Voltage	0 – 25.5V	0.1V
NEED-24DC-..	Voltage	0 – 25.5V	0.1V
NEED-12DC-...-16-8	Voltage	0 – 12.75V	0.05V
NEED-24DC-...-16-8	Voltage	0 – 12.75V	0.05V
NEED-12DC-...-16-8	Current	0 – 51mA	0.2mA
NEED-24DC-...-16-8	Current	0 – 51mA	0.2mA
NEED-12DC-...-16-8	Current	0 – 25.5mA	0.1mA
NEED-24DC-...-16-8	Current	0 – 25.5mA	0.1mA

An example of the A10 Comparator configuration for comparing the values of signals at the I14, I15 analog inputs is shown fig. 4.11.5.

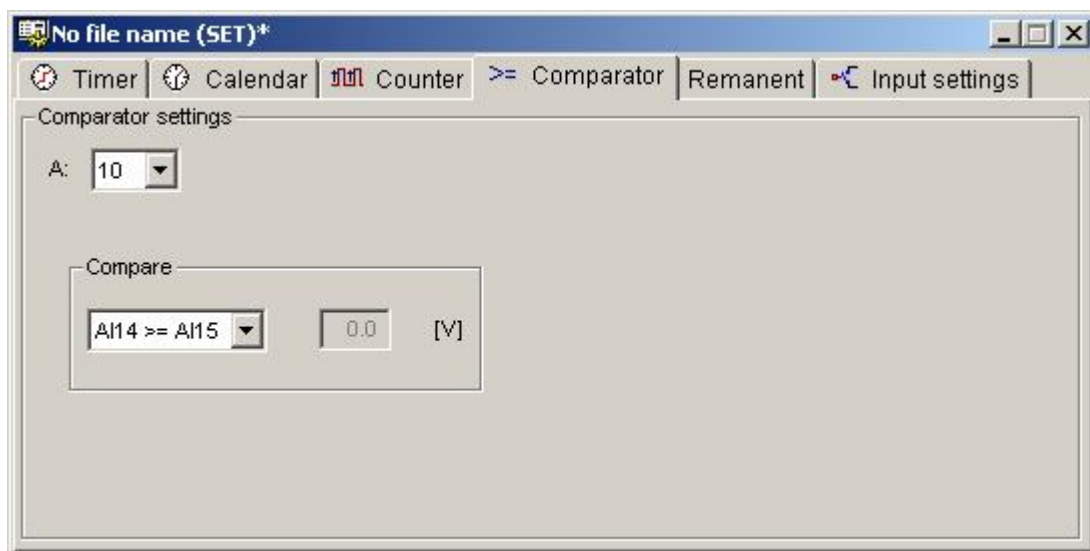

Fig. 4.11.5. An example of the A10 comparator configuration for comparison of two analog values.



The A10 Comparator output is set to '1', when the voltage value at the I14 analog input is equal to, or greater than the value at the I15 analog input.

If any analog input of the NEED relay is configured as a current input, then only the **voltage** value is taken for comparison, according to the following formula:

*The comparator voltage value [V] = 0,5*value of the current measured at the input [mA]*

This is linear scaling, where 20mA is equal to 10V.

Example:

A current output sensor is connected to the I16 analog input. We want the measured analog value (for example pressure), “converted” to current, not to exceed 10mA.

The A1 comparator must be configured as shown in fig. 4.11.6. – according to the formula presented above.

$0,5 * 10\text{mA} = 5\text{V}$

Enter 5 in the field on the left.

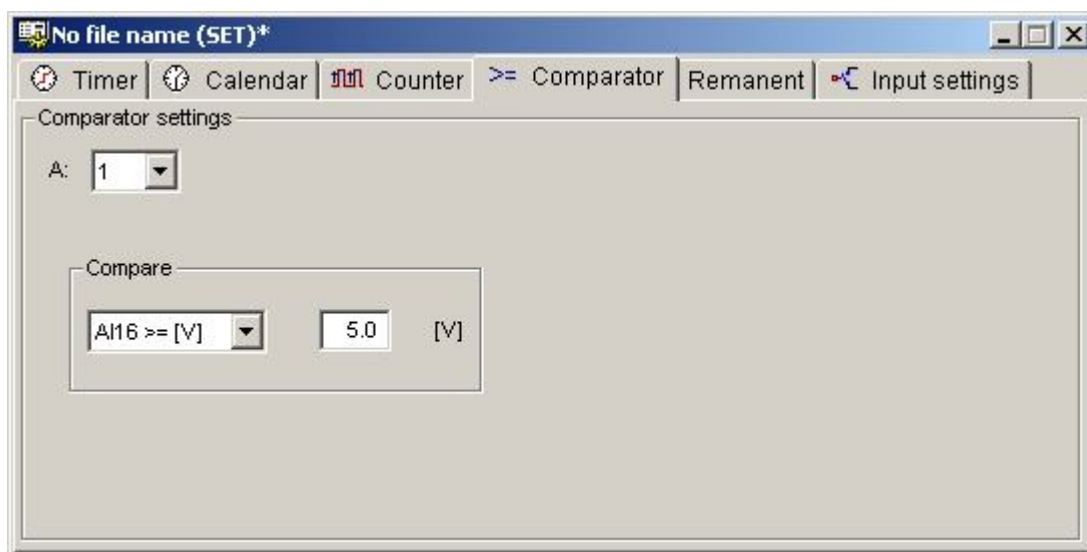

Fig. 4.11.6. An example of the A1 comparator configuration in the PC Need program for the A16 analog input configured as a current input.



In the NEED-230AC-.. relay the analog inputs are read every 4ms. This delay does not depend on the delay settings for the I7, I8 or I14, I15, I16 with configuration through the PC Need software – please refer to section “8.4. Input delays”.

For relays: NEED-12DC-.. and NEED-24DC-.. delay settings for the I7, I8 or I14, I15, I16 analog inputs will cause averaging of the measured values read, according to the following formula:

Current value = (previous value + value read from the analog input) / 2

Analog inputs in NEED-12DC-.. and NEED-24DC-.. relays are read every 4ms.

4.12. Potentiometer

Potentiometer is a typical hardware resource and can be used to:

- adjust times for Timers,
- adjust values to be counted by Counters,
- adjust switching threshold of the Comparator, .

Full turn of the Potentiometer corresponds to values 1 - 255. Appropriate Potentiometer values can be set using „L” instruction (STL – see Item 5.1.2.21., LAD - see Item 5.2), in which the Potentiometer ranges can be modified by means of a program, in order to better adapt them to the expected measured value. An example of the use of Potentiometer is presented in Fig. 4.11.1.

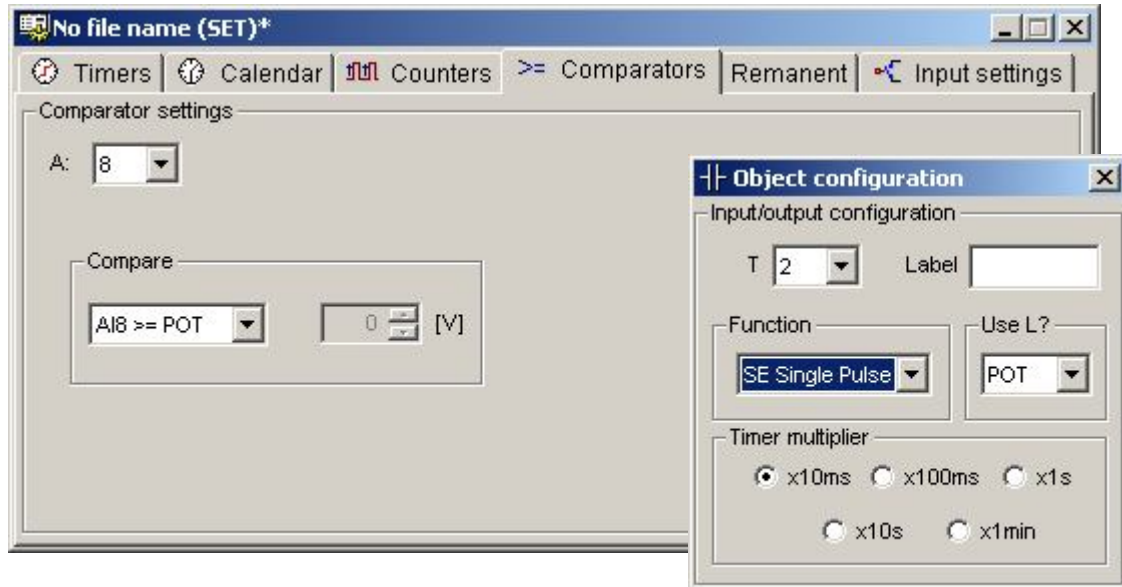

Fig. 4.11.1. Example of the use of the Potentiometer.

In the above example T1 Timer will measure time the length of which is equal to:
*Potentiometer setting x 10ms (e.g. 12*10=120ms)*

At the same time the Comparator A8 output will be at high state when the value of voltage present at the I8 analogue input is higher than the value set with the Potentiometer (1 – 255).

4.13. Remanent values of the programmable relay

It is frequently required in the control processes that data must be retained after power off. The programmable relay allows definition of some „areas” of the relay resources, to be the so-called remanent resources, which can be backed up during power off or after switching the relay to STOP mode. Resources which can be defined as remanent are presented in Table 4.11.1.

Table 4.11.1. Remanent resources in NEED programmable relay.

Remanent resources	Range
Markers	M1– M16
Timers	T5 – T8
Counters	C5 – C8

In order to define the programmable relay resources as remanent, respective fields must be marked in the PC Need configuration application. Sample configuration of relay remanent values is presented in Fig. 4.11.2.

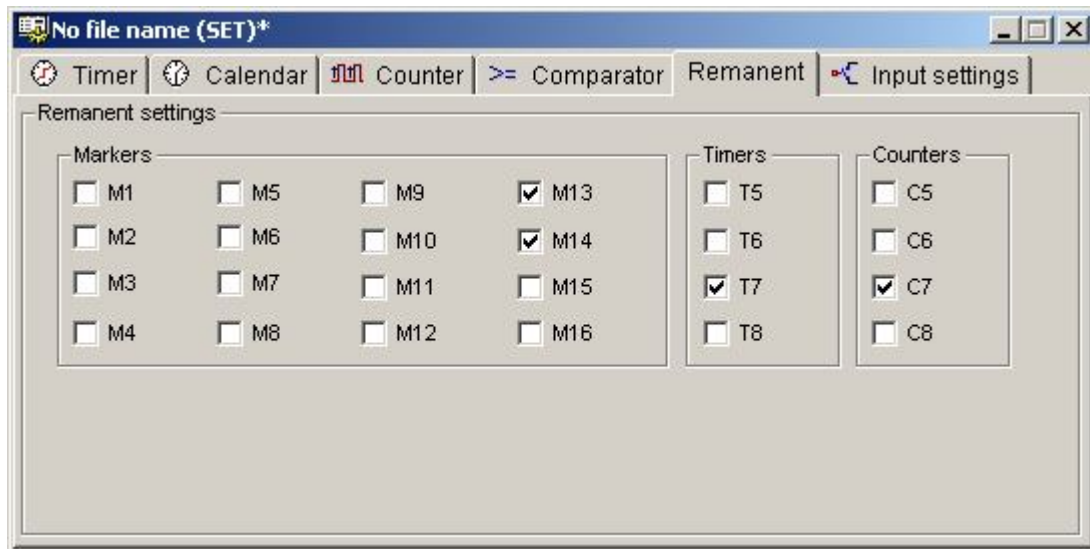

Fig. 4.11.2. Sample configuration of remanent resources.

Markers M13, M14, Timer 7 and Counter 7 were configured as remanent in the above example.

Such configuration should be made in the relay STOP mode.

Remanent resources are not factory-set, neither are they set after a RESET operation.



Remanence setting may cause unexpected program execution due to undefined initial conditions.

4.13.1. Remarks on remanent values

1. Markers

If the Marker is set as remanent then, after switching the power off and on again or after the relay has gone through the cycle of RUN → STOP → RUN, it will “remember” the logical state it had before the power off.

Example:

Let's set Marker M7 as remanent.

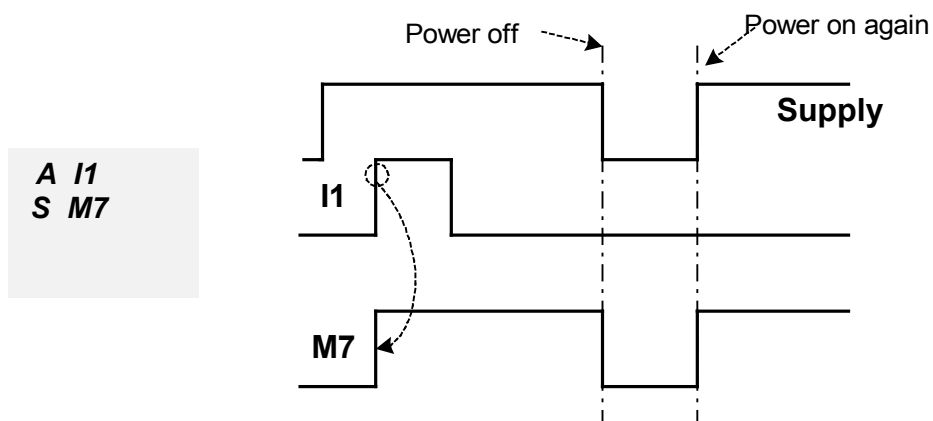

Fig. 4.12.1.1. Remanence of Marker M7.

Once the power is switched off and on again the state of M7 is high, despite I1='0'.

2. Timers

If the Timer is set as remanent then, after switching the power off and on again or after the relay has gone through the cycle of RUN → STOP → RUN, it will “remember” the logical state it had before the power off.

Example:

Let's set Timer T5 as remanent

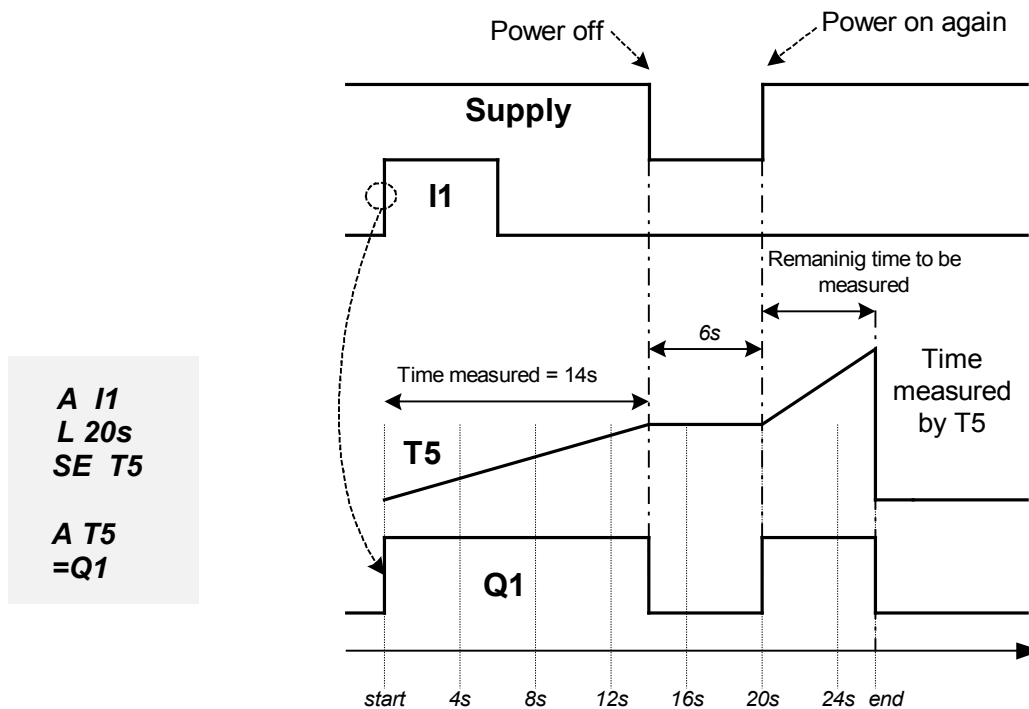

Fig. 4.12.1.2. Remanence of Timer T5.

Once triggered, T5 Timer starts the time measurement. After power off at 14s the time measured is remembered, and once the power is on again the Timer resumes the measurement of the 20 s period and sets its output to high for the remaining 6 seconds.

3. Counters

If the Counter is set as remanent it will remember its logical state and the number of pulses counted after the power is switched off and then on again.

Example:
Let's set Counter C5 as remanent

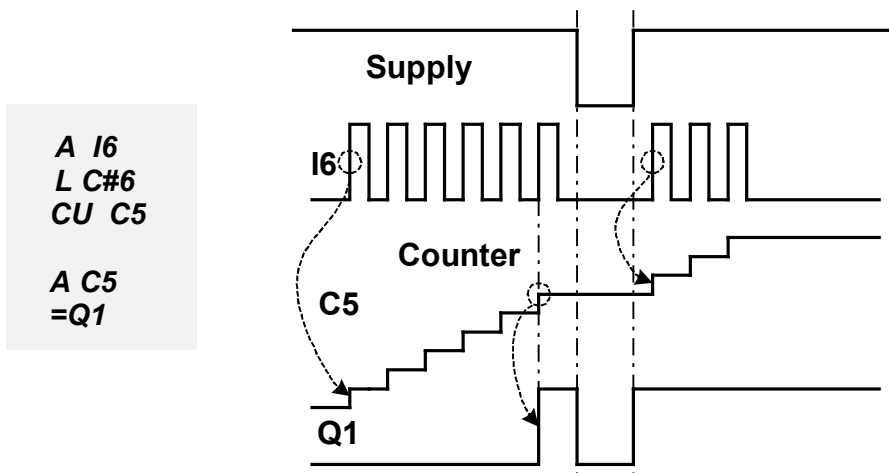

Fig. 4.12.1.3. Remanence of Counter C5.

Pulses that occur at I6 increase the value of Counter C5. Once the power is switched off and on again the Counter remembers its value and the original state it had before the power off. Further triggering pulses cause the Counter to count not from zero but starting from the value remembered before the power off.



A remanent Counter will count the pulse if the input state was '0' before the power off and '1' after the power on. Such a pulse will not be counted by a non-remanent Counter.

If the Counter input state was '1' before the power off and it remained high after the power on, a remanent Counter will not count such a pulse.

4.14. Keyboard buttons

The NEED relays with support for LCD panel and keyboard have four buttons: B1-B4.

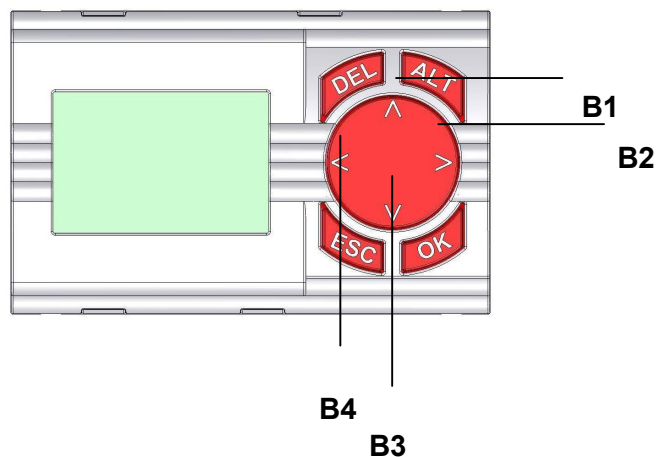

The buttons follow the same principles as inputs.

4.14.1. Buttons as normally open digital inputs

Symbols for buttons as normally open digital inputs.

STL	LAD
A B1 or O B1 or X B1	

SYMBOL: **Bn**, where n is the input number n=1..4 for NEED-..-D

LOGIC STATES:

'1' – button is pressed

'0' – button is not pressed

4.14.2. Buttons as normally closed digital inputs

Symbols for buttons as normally closed digital inputs.

STL	LAD
AN B1 or ON B1 or XN B1	

SYMBOL: **Bn**, where n is the input number n=1..4 for NEED-...-D

LOGIC STATES:

'0' – button is pressed

'1' – button is not pressed



In NEED-..-22-.. relays the B1-B4 resources are available regardless of whether a panel is installed or not.

5. PROGRAMMING LANGUAGES

NEED relay can be programmed using two programming languages. They were defined in such a way as to make the relay programming as effective as possible and to provide user with a possibility to select the most convenient programming language. Hence, the following languages can be used to describe control tasks:

- text language – Statement List (STL),
- graphic language – Ladder Diagram (LAD),

5.1. Text language (STL) programming

STL text language (*Statement List*) is a set of instructions comprising logical operations, relations as well as functions of flip-flops, timers, counters etc. which allow proper programming of the relay. The use of a text language for programming of the NEED relay is very efficient and produces an object code which is closest to the internal structure of the program.

5.1.1. STL program structure

An STL program is a sequence of successively executed instructions.

Each instruction is composed of two elements:

- 1) Instruction symbol - identifier (code), which is a keyword in STL language,
- 2) Argument i.e. variable.

<code>	<argument>
A, A(, AN, AN(, O,O(, ON, ON(X, X(, XN, XN(S, R, =, FP SD, SF, SE, SL CU, CD L, SET, CLR	I,Q,M, MT, MDIR, H, A, T, C, HC1, H L-Counter ¹⁾ L- Timer ²⁾

1- *L-Counter* – is a set number of counts to be performed by the Counter.

2- *L-Timer* – is a set time to be measured by the Timer.

Logical notation of some sequences, of which the program is composed, consists of a condition (so-called preceding part) and a result (so-called successive part). In other words if the conditions, noted using specific instructions and variables, are met that situation will yield a result which is also noted using specific instructions and variables. Such composition of a condition and a statement is called a circuit.

Thus, the following record type is allowed:

```

A I1
A I2
S Q5
```

However, it is not allowed to use an entry like this:

```

I1
A I2
S Q5
```

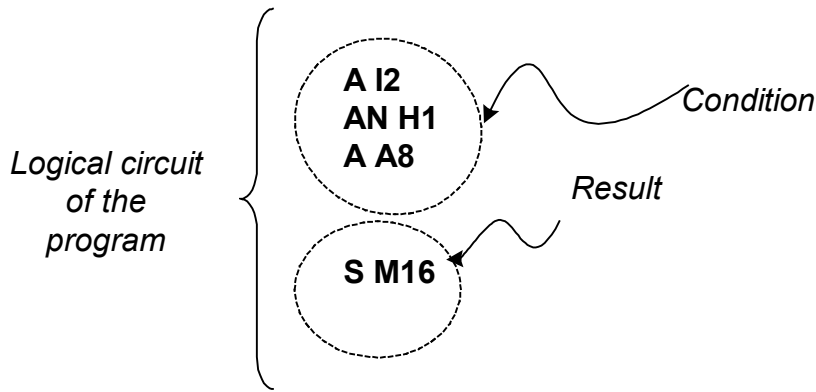

Fig 5.1.1.1. STL program structure

Example:

1)	A I1	}	<i>Condition (checks relations: I1 AND A2)</i>
2)	A A2		
3)	S Q4	}	Result
4)	R Q1		

Instructions recorded in lines 1 and 2 are conditions in this example. If both conditions are met, the I1 output and A2 comparator output states being high, then the Q4 output will be set (state '1') and Q1 output will be reset (state '0'). Thus instructions 'S Q4' and 'R Q1' are the result.

Instructions: A, A(, AN, AN(, O, O(, ON, ON(, X, X(, XN, XN(compose the conditional part of the circuit while the instructions: S, R, =, FP, SD, SF, SL, SE, CD, CU are the resultant part of the circuit.

Each separate circuit should begin with a condition and end with a result.

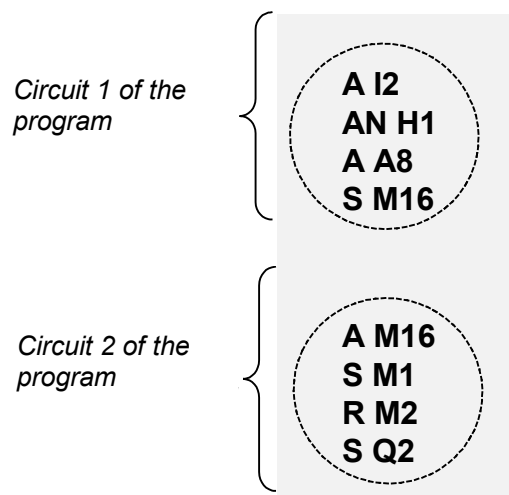

Fig.5.1.1.2. Two sample circuits in STL.

There is only one program in the programmable relay which cannot be split into subroutines to be called.

The controller processor executes individual instructions successively, beginning with the first and ending with the last one. Once the last instruction is executed the program cycle is repeated. Controller program processing is presented in Fig. 5.1.1.3.

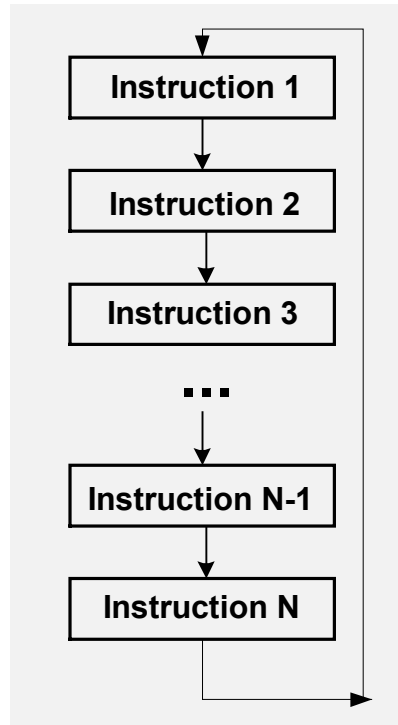

Fig. 5.1.1.3. STL program processing.

Table 5.1.1. contains all available STL instructions.

Table 5.1.1. STL instructions.

STL Instruction	Description	Operands
A	AND instruction	I,Q,M,MT,MDIR,A,H,C,HC1,T
A(AND parenthesis instruction	
AN	AND NOT instruction	I,Q,M,MT,MDIR,A,H,C,HC1,T
AN(AND NOT parenthesis instruction	
O	OR instruction	I,Q,M,MT,MDIR,A,H,C,HC1,T
O(OR parenthesis instruction	
ON	OR NOT instruction	I,Q,M,MT,MDIR,A,H,C, HC1,T
ON(OR NOT parenthesis instruction	
X	XOR instruction	I,Q,M,MT,MDIR,A,H,C,HC1,T
X(XOR parenthesis instruction	
XN	XOR NOT instruction	I,Q,M,MT,MDIR,A,H,C, HC1,T
XN(XOR NOT parenthesis instruction	
S	Setting instruction	Q,M,MT
R	Resetting instruction	Q,M,MT,T,C,HC1
=	Assigning instruction	Q,M,MT
FP	Pulse relay	Q,M,MT
L	Loading instruction	Constant operand value

Table 5.1.1. STL instructions – ctd.

STL Instruction	Description	Operands
SD	Timer – Delayed turn-on	T
SE	Timer – Delayed turn-off	T
SF	Timer – Single pulse	T
SL	Timer – Pulses	T
CU	Counter – Up-count	C, HC1
CD	Counter – Down-count	C, HC1
SET	„Always setting” instruction	
CLR	„Always clearing” instruction	

5.1.1.1. Symbolic names

For the NEED relays it is possible assign symbolic names to variables in a project. This way the program is easier to analyze and clearer.

To associate a variable with a symbolic name, use an expression with the following syntax:

. DEFINE < symbolic name > = < variable >

After that a symbolic name preceded with the % character can be used instead of the variable address, such as Q1, I11, for example:

```
.DEFINE Pump = Q1
.DEFINE Failure = I11

A %Failure
R %Pump
```

Symbolic names are case insensitive.

Names of relay resources and statements cannot be symbolic names.

Symbolic names may not begin with a digit, and can contain up to 30 characters.

5.1.2. Description of STL instructions

5.1.2.1. AND instruction

SYMBOL - **A**

'A' instruction is a logical instruction of AND type.

SYNTAX:

A < I,Q,M,MT,MDIR,A,H,C,HC1,T >

Instruction execution time: 6 μs

Example:

STL

Relay diagram

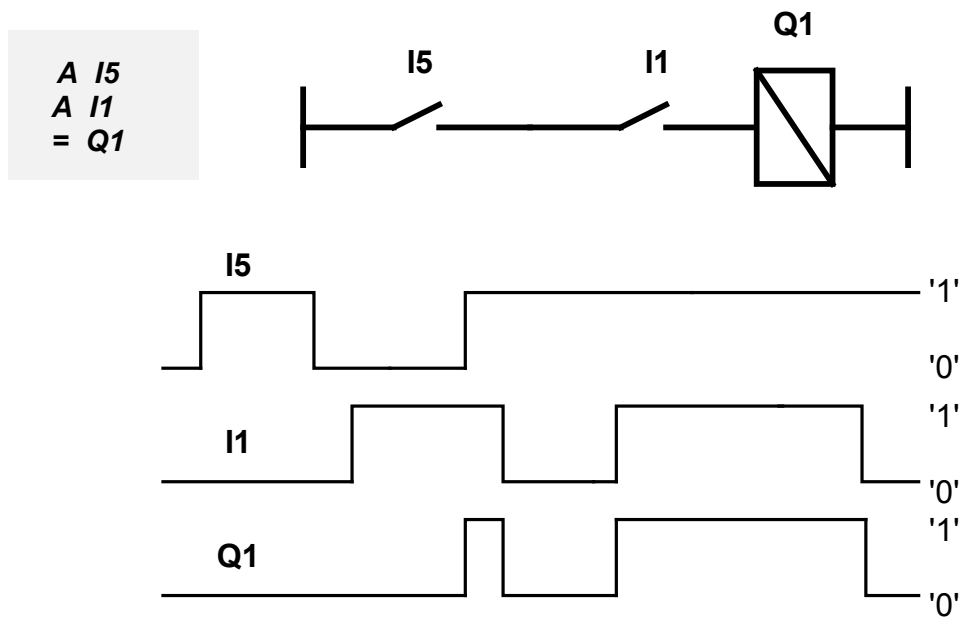

Fig. 5.1.2.1. Sample time series at I5 and I1 inputs and Q1 output.

The example above employs a series connection.

Q1 output will be set (state '1') when states of both inputs are high, according to the principle of AND function.

5.1.2.2. AND parenthesis instruction

SYMBOL – **A(**

'A(' is a logical instruction of AND, type the operand of which is the result of logical operations given in the parentheses.

SYNTAX:

A(

Conditional instructions

)

Instruction execution time: 6μs

Figure 5.1.2.2.1. illustrates the principle of execution of the 'A(' instruction. All other „parenthesis” instructions are based on the same principle.

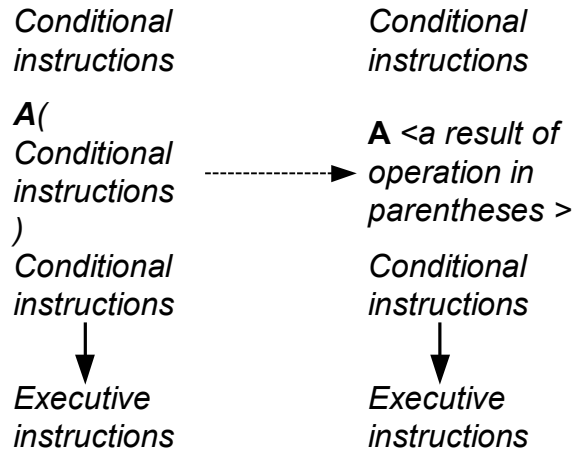

Fig. 5.1.2.2.1. Principle of 'A(' "parenthesis" instruction.

Parenthetical operations are performed. The logical operations produce a result ('0' or '1'), which is used in subsequent logical operations for example in the program:

```

A I1
A(
  O M1
  O M2
)
=Q1 // it is equivalent to I1 AND (M1 OR M2) = Q1 logical operation
  
```

and logical states: M1='0', M2='0', I1='1'.
Thus, it can be noted that:

```

A I1      A '1'
A(      A '0' //because '0' O '0' = '0'
  O M1
  O M2
)
=Q1      = '0'
  
```

Which means that, for the states analysed, the Q1 output state will be '0' while in case of states M1='1', M2='0', I1='1' the following results are produced:

```

A I1      A '1'
A(      A '1' //because '1' O '0' = '1'
  O M1
  O M2
)
=Q1      = '1'
  
```

Example:
STL

Relay diagram

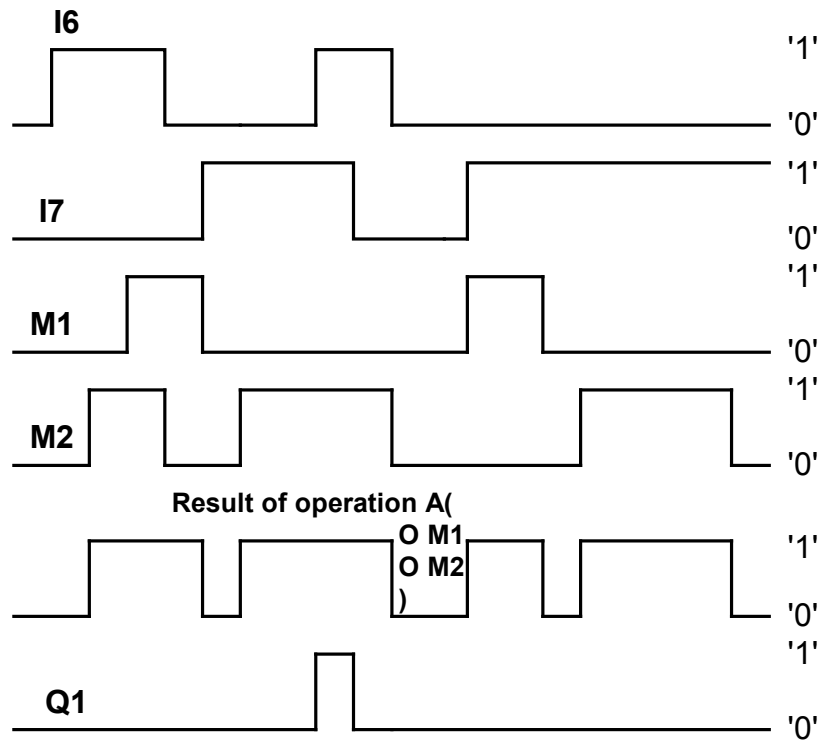
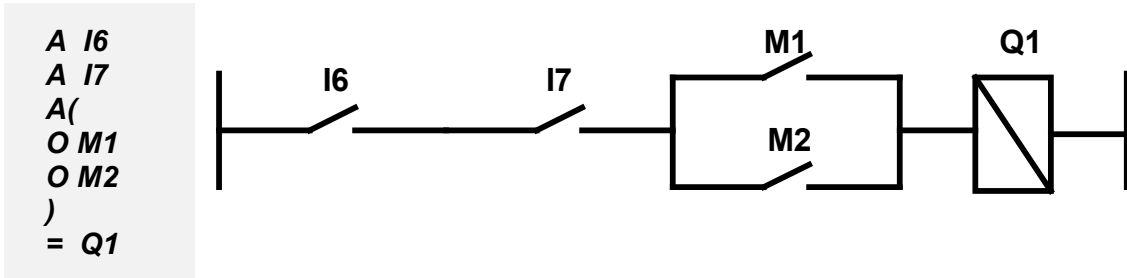

Fig. 5.1.2.2.2. . Sample time series at I6, I7 , M1 and M2 inputs and Q1 output.

Q1 output will be set (state '1') when states of I6 and I7 inputs are high and one of the Markers (M1 or M2) is at state '1'.

5.1.2.3. *AND NOT* instruction

SYMBOL - **AN**

'AN' instruction is a logical instruction of *AND NOT* type (*AND* instruction with negated operand state).

SYNTAX:

AN < I,Q,M,MT,MDIR,A,H,C,HC1,T >

Instruction execution time: 6µs

Example:

STL

Relay diagram

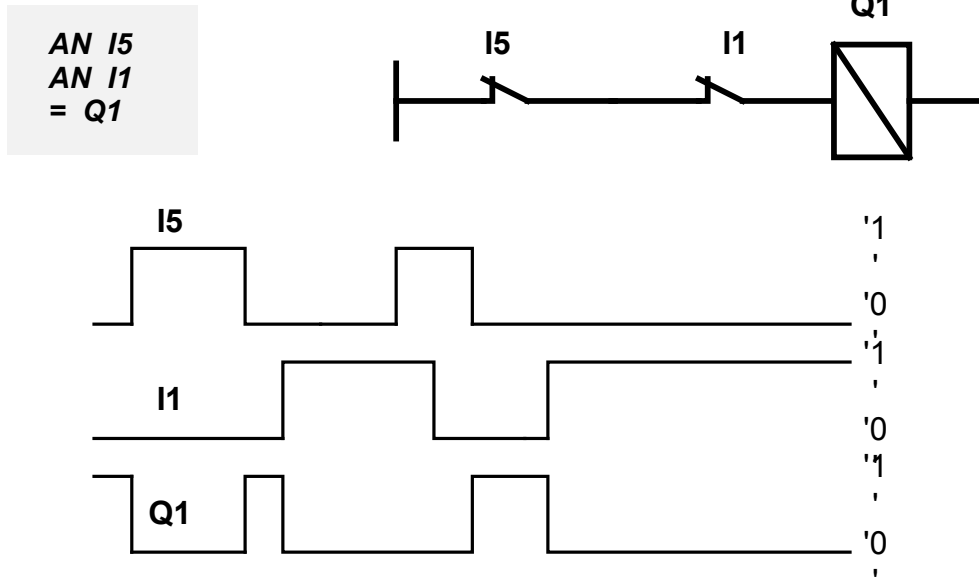

Fig. 5.1.2.3. Sample time series at I5 and I1 inputs and Q1 output.

Comments:

Q1 output will be set (state '1'), when states of both inputs are low ('0').

5.1.2.4. *AND NOT* parenthesis instruction

SYMBOL - **AN(**

'AN(' is a logical instruction of *AND NOT* type the operand of which is the result of logical operations given in the parentheses.

SYNTAX:

AN(

Conditional instructions

)

Instruction execution time: 6µs

Example:
STL

```
A I6
A I7
AN(
O M1
O M2
)
= Q1
```

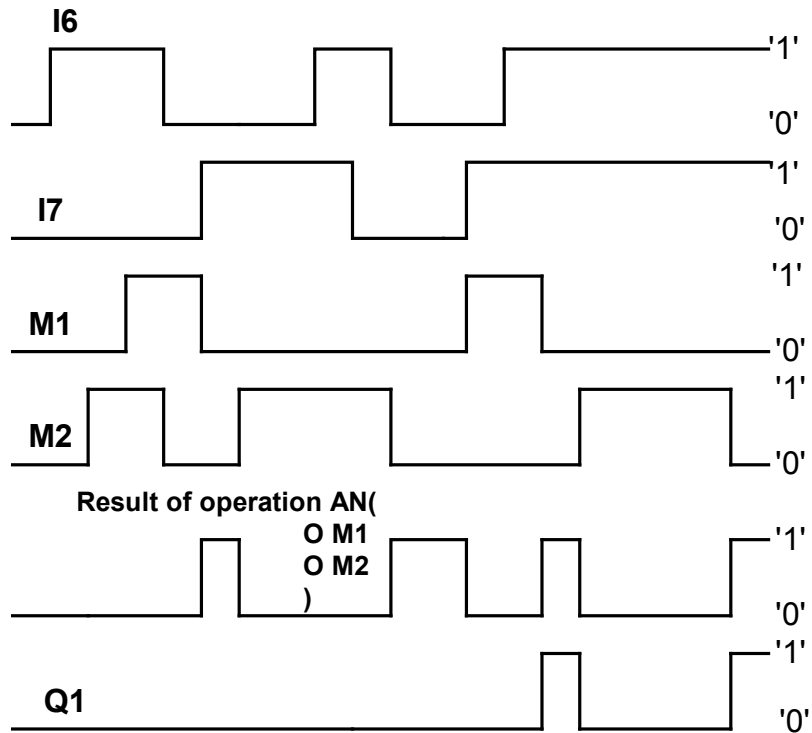

Fig. 5.1.2.4. Sample time series at I6, I7, M1 and M2 inputs and Q1 output.

Comment:

Q1 output will be set (state '1') when states of I6 and I7 inputs are high and both Markers (M1 and M2) are at state '0'.

5.1.2.5. OR instruction

SYMBOL - O

'O' instruction is a logical instruction of OR type

SYNTAX:

O < I,Q,M,MT,MDIR,A,H,C,HC1,T >

Instruction execution time: 6µs

Example:
STL

```
O I5
O I1
= Q1
```

Relay diagram

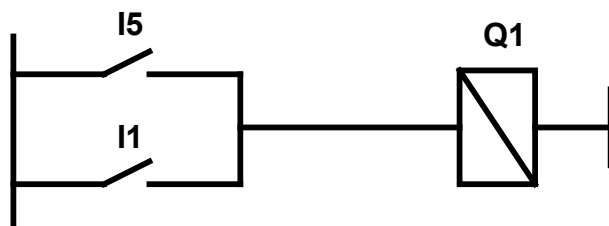

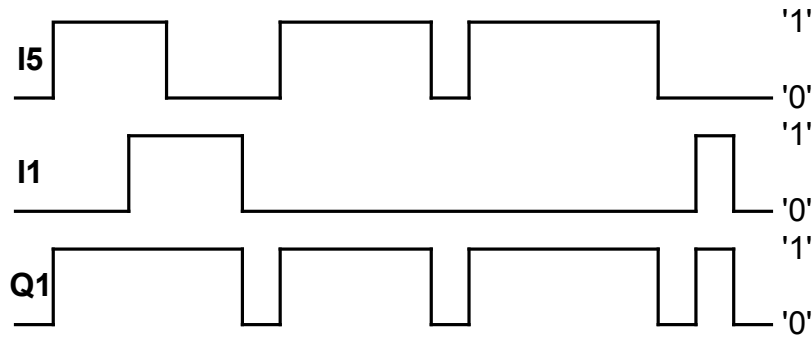

Fig. 5.1.2.5. Sample time series at I5 and i1 inputs and Q1 output.

Comment:

Q1 output will be set (state '1'), when state of one the inputs is high ('1').
Parallel connection is employed.

5.1.2.6. OR parenthesis instruction

SYMBOL – O(

'O(' is a logical instruction of OR type the operand of which is the result of logical operations given in the parentheses.

SYNTAX:

O(

Conditional instructions

)

Instruction execution time: 6µs

Example:

STL

Relay diagram

```

A I6
A I7
O(
A M1
A M2
)
= Q1
    
```

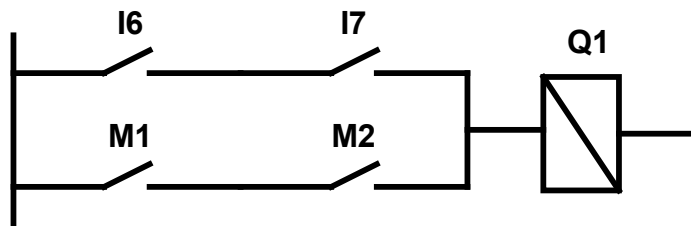

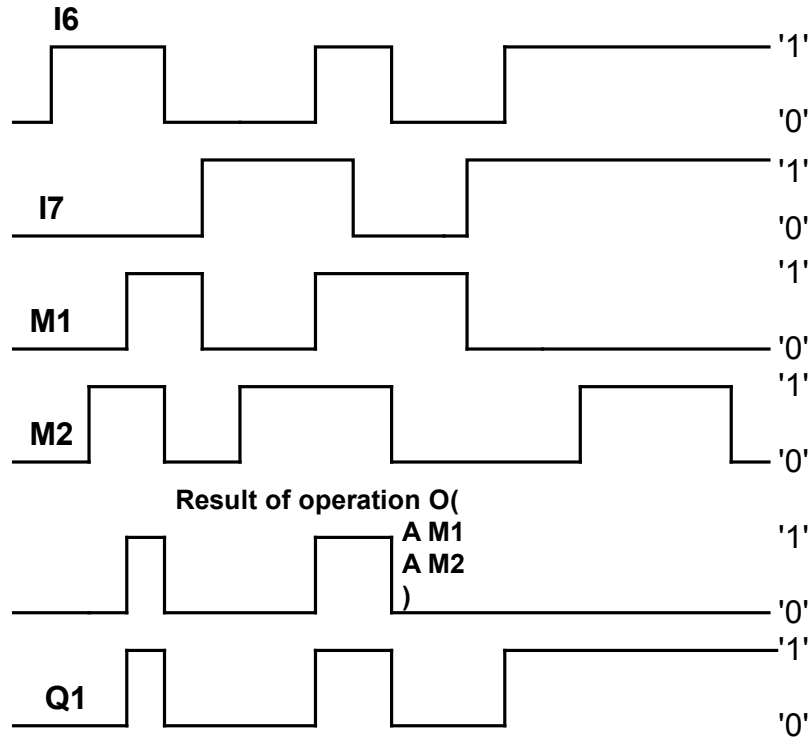

Fig. 5.1.2.6. Sample time series at I6, I7 , M1 and M2 inputs and Q1 output.

Q1 output will be set (state '1') when states of I6 and I7 inputs are high or both Markers (M1 or M2) are at state '1'.

5.1.2.7. OR NOT instruction

SYMBOL - **ON**

'O' instruction is a logical instruction of OR NOT type (OR instruction with negated operand state).

SYNTAX:

ON < I,Q,M,MT,MDIR,A,H,HC1,C,T >

Instruction execution time: 6µs

Example:

STL

Relay diagram

**ON I5
ON I1
= Q1**

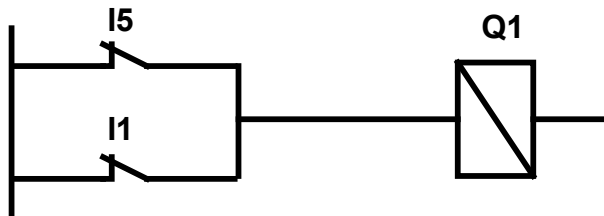

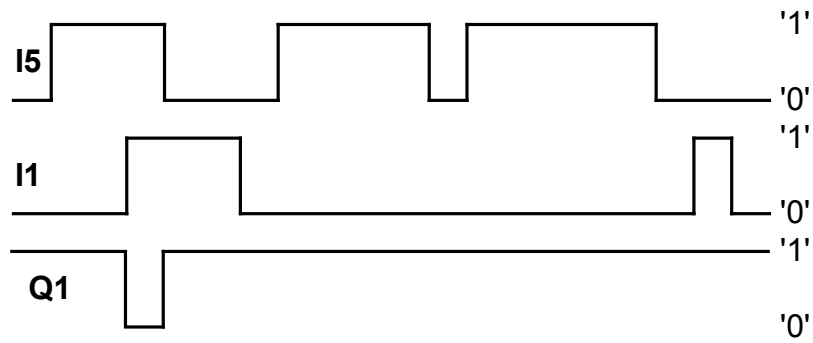

Fig. 5.1.2.7. Sample time series at I5 and I1 inputs and Q1 output.

Comment:

Q1 output will be set (state '1'), when state of at least one the inputs is low ('0').

5.1.2.8. OR NOT parenthesis instruction

SYMBOL – **ON(**

'ON(' is a logical instruction of OR NOT type of the result of logical operations given in the parentheses.

SYNTAX:

ON(

Conditional instructions

)

Instruction execution time: 6µs

Example:

STL

```
A I6
A I7
ON(
A M1
A M2
)
= Q1
```

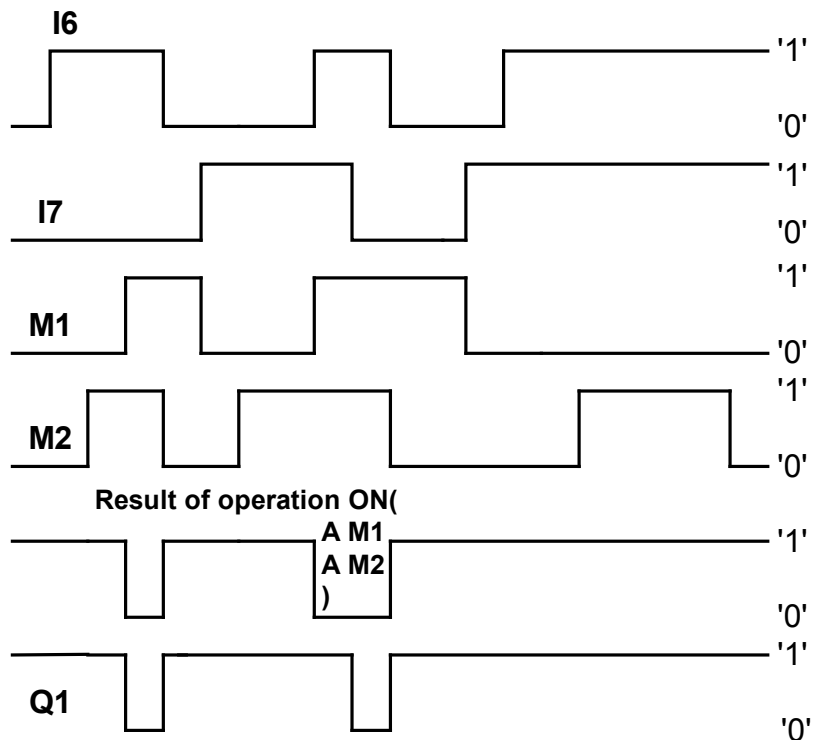

Fig. 5.1.2.8. Sample time series at I6, I7, M1 and M2 inputs and Q1 output.

Q1 output will be set (state '1') when states of I6 and I7 inputs are high or one of the Markers (M1 or M2) is at state '0'.

5.1.2.9. XOR instruction

SYMBOL - **X**

'X' instruction is a logical instruction of XOR type

SYNTAX:

X < I,Q,M,MT,MDIR,A,H,C,HC1,T >

Instruction execution time: 6µs

Example:

STL

Relay diagram

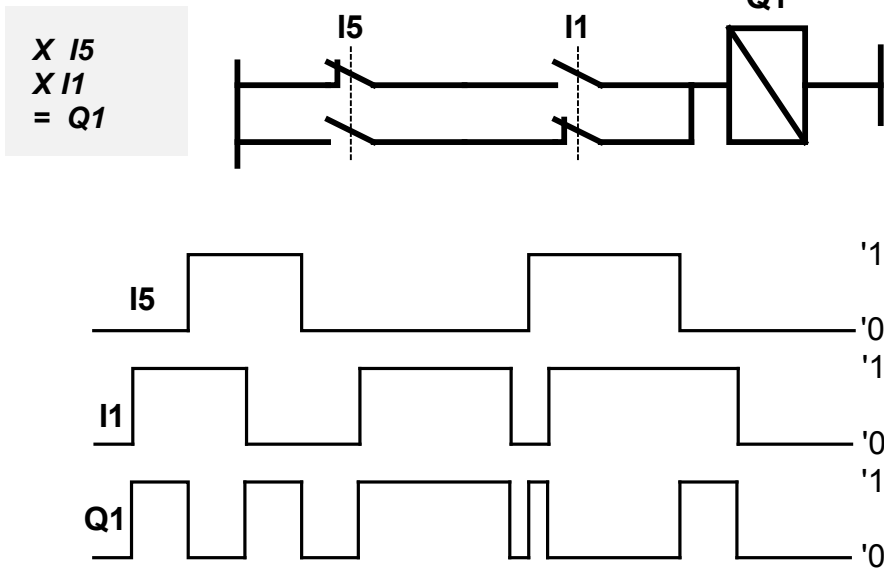

Fig. 5.1.2.9. Sample time series at I5 and I1 inputs and Q1 output.

Q1 output will be set (state '1') when states of I5 and I1 inputs are opposite (I5='1' and I1='0' or I5='0' and I1='1').

5.1.2.10. XOR parenthesis instruction

SYMBOL - **X(**

'X(' is a logical instruction of XOR type the operand of which is the result of logical operations given in the parentheses.

SYNTAX:

X(

Conditional instructions

)

Instruction execution time: 6µs

Example:
STL

```

A I7
X(
A M1
A M2
)
= Q1
    
```

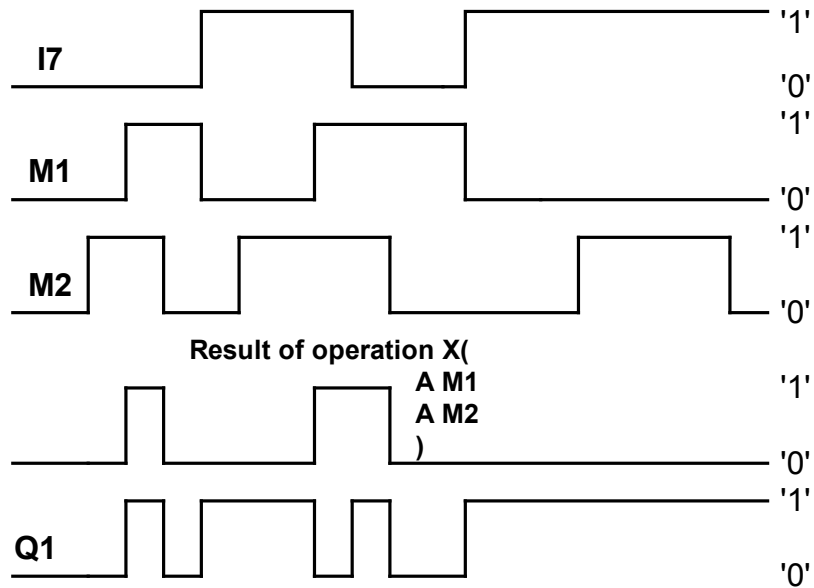

Fig. 5.1.2.10. Sample time series at I7, M1 and M2 inputs and Q1 output.

Q1 output will be set (state '1') according to the principle of XOR function, i.e.:
 Q1=1 for I7=1 and one of the Markers is set to '0' state.
 Q1=1 for I7=0 and both Markers are set to high state ('1').

5.1.2.11. XOR NOT instruction

SYMBOL - **XN**

'XN' instruction is a logical instruction of XOR NOT type

SYNTAX:

X < I,Q,M,MT,MDIR,A,H,HC1,C,T >

Instruction execution time: 6µs

Example:
STL

Relay diagram

```

X I5
XN I1
= Q1
    
```

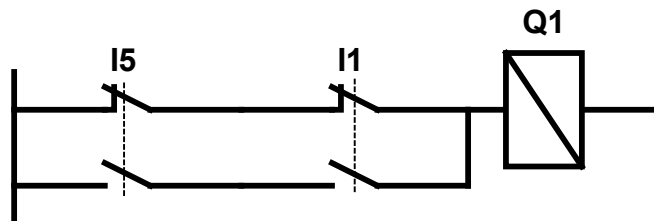

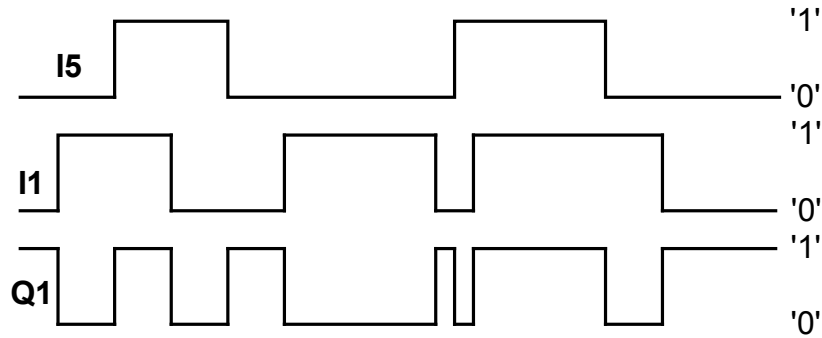

Fig. 5.1.2.11. Sample time series at I5 and I1 inputs and Q1 output.

Q1 output will be set (state '1') when logical states of I5 and I1 inputs are the same (I5='0' and I1='0' or I5='1' and I1='1').

5.1.2.12. XOR NOT parenthesis instruction

SYMBOL – **XN(**

'XN(' is a logical instruction of XOR NOT type of the result of logical operations given in the parentheses.

SYNTAX:

XN(

Conditional instructions

)

Instruction execution time: 6µs

Example:

STL

Relay diagram

```

A I7
XN(
A M1
A M2
)
= Q1
    
```

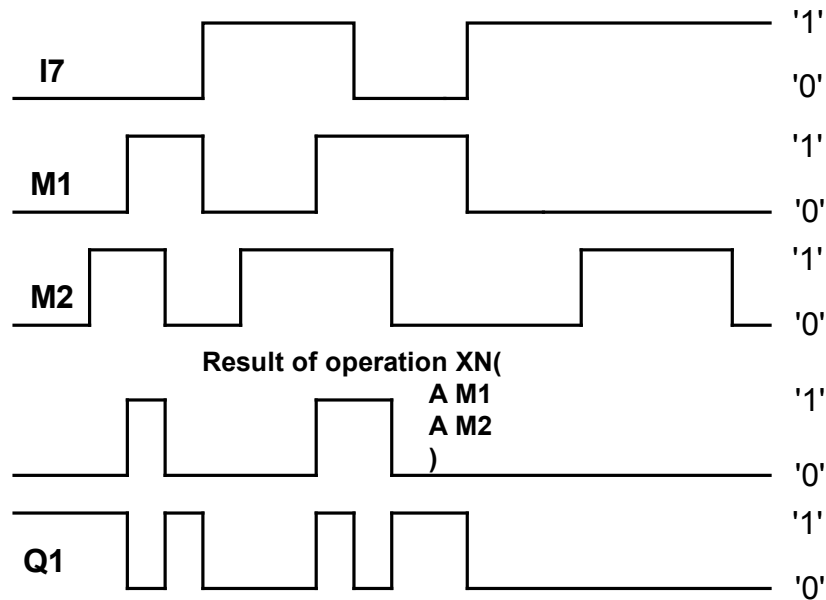

Fig. 5.1.2.12. Sample time series at I7, M1 and M2 inputs and Q1 output.

Q1 output will be set (state '1') according to the principle of XOR NOT function, i.e.:
 Q1=1 for I7=1 and states of both Markers (M1 and M2) are high ('1').
 Q1=1 for I7=0 and state of one of the Markers is low ('0').

5.1.2.13. S setting instruction

SYMBOL - **S**

'S' instruction is a logical instruction that sets the operand to high state ('1')

SYNTAX:

S < Q,M,MT >

Instruction execution time: 6µs

Example:

STL

Relay diagram

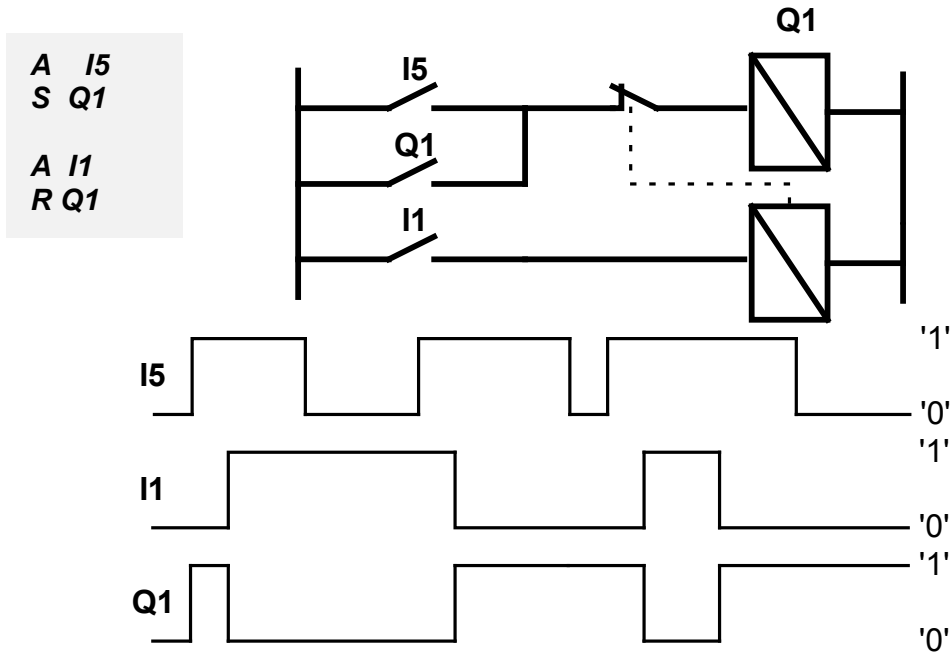

Fig. 5.1.2.13. Sample time series at I5 and I1 inputs and Q1 output.

Q1 output will be set (state '1') when the state of I5 input is high ('1'). It will remain in that state until low state ('0') is set using 'R' instruction – I1 input.

5.1.2.14. R resetting instruction

SYMBOL - **R**

'R' instruction is a logical instruction that sets the operand to low state ('0')

SYNTAX:

R < Q,M,MT,T,C,HC1 >

Instruction execution time: 6,5µs

Example: See 'S' instruction

5.1.2.15. = assigning instruction

SYMBOL - **=**

The instruction of '=' is a logical instruction in which the operand takes on a value ('0' or '1' state) which depends on the result of previous logical operations

SYNTAX:

= < Q,M, MT >

Instruction execution time: 6,7µs

Example:
STL

Relay diagram

```
A I5
A I1
= Q1
```

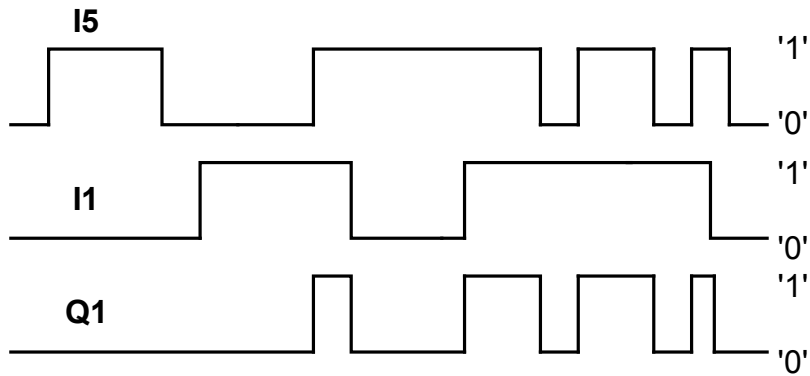
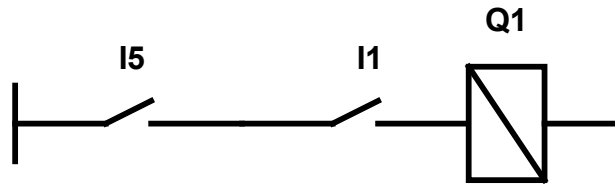

Fig. 5.1.2.15. Sample time series at I5 and I1 inputs and Q1 output.

Q1 output state depends on previous logical operations i.e. it takes on '0' state when the state of one of the inputs is '0', or it takes on the state '1' when the states of both inputs are '1'.

5.1.2.16. FP pulse relay instruction

Pulse relay performs the function of a flip-flop triggered by the leading edge. Each leading pulse changes the output state to opposite.

SYMBOL - **FP**

SYNTAX:

FP < Q,M,MT >

Instruction execution time: 5,9µs

Example:
STL

Relay diagram

```
A I1
FP Q1
```

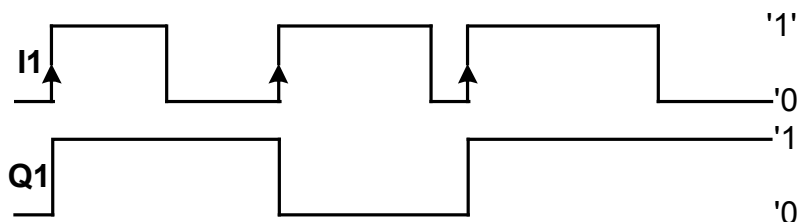
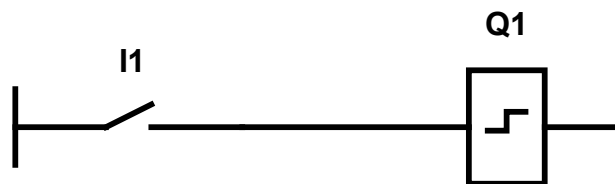

Fig.5.1.2.16. Sample time series at I1 input and Q1 output.

If the state of Q1 output remains low and a positive control edge occurs at I1 input then the Q1 output state will be set to high.
 If the state of Q1 output remains high and a positive control edge occurs at I1 input then the Q1 output state will be set to low.

5.1.2.17. Timer instructions

5.1.2.17.1. Timer „Delayed turn-on” (ON-DELAYED)

Timer delays the turn-on.

SYMBOL - **SD**

SYNTAX:

SD <T>

Instruction execution time: 8.3µs

Example:

```

A I8
L 400ms
SD T1

A T1
= Q1

A I1
R T1
    
```

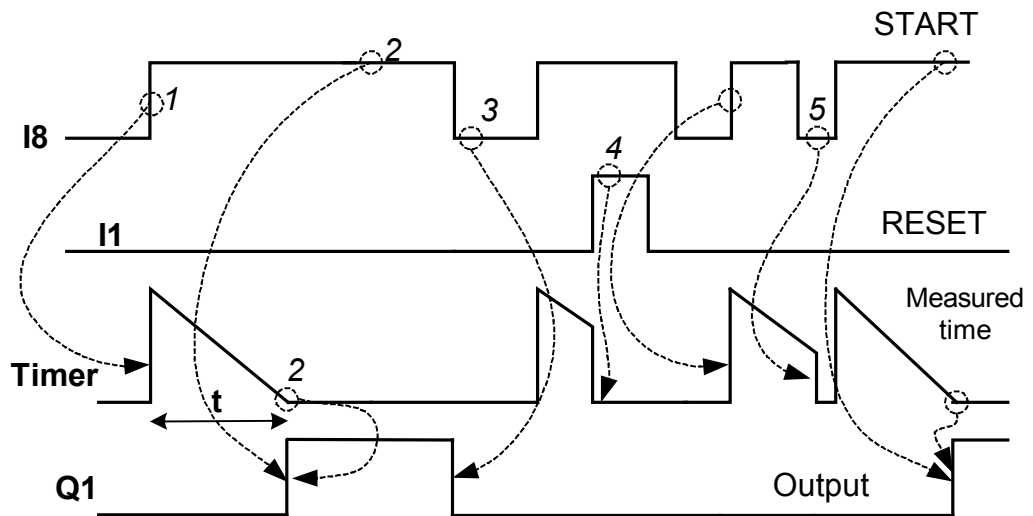

Fig. 5.1.2.17.1. Sample signal time series illustrating the operation of SD Timer.

1. I8 input performs the function of a triggering input (Trigger). Directly after the triggering instruction there is an instruction ('L') loading the specified time value to be measured. The latter instruction should be put directly before Timer instruction (SD). Time is measured after the execution of SD Timer activation instruction (leading edge at I8 input).
2. After a time of t=400ms the Q1 output state is set to high ('1'). At the same time a high ('1') signal should be retained at the I8 triggering input.
3. If a low state occurs at the I8 Trigger input the measured time counter of T1 Timer is reset and Q1 output is set to low ('0').
4. If a high state appears at the I1 input resetting the T1, the measured time T1 Timer will be automatically cleared, and the Q1 output is set to the low state ('0'). If the "L" statement is not used, then the time to be measured by T1 will be set from the "*.set" configuration file (settings window in the PC Need program).

5.1.2.17.2. Timer – Delayed turn-off (OFF-DELAYED)

Timer delays the turn-off.

SYMBOL - **SF**

SYNTAX:

SF <T>

Instruction execution time: 8.3µs

Example:

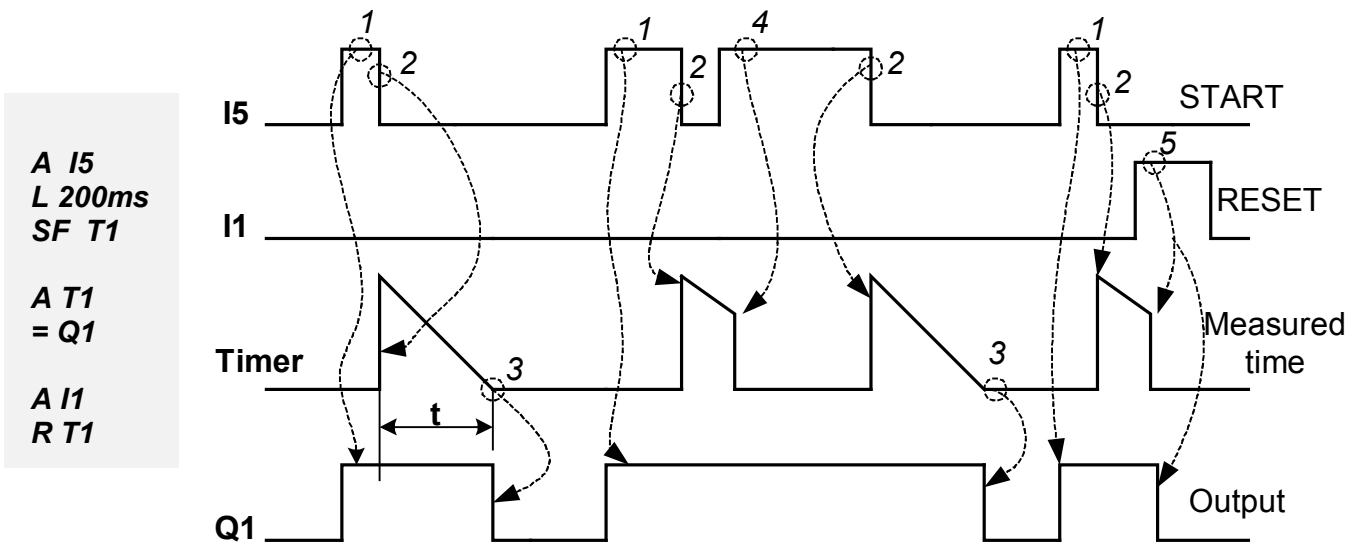

Fig. 5.1.2.17.2. Sample signal time series illustrating the operation of SF Timer.

1. The I5 input performs the function of a triggering input (Trigger). Directly after the triggering instruction there is an instruction ('L') which loads the specified time value to be measured. The latter instruction should be put directly before the Timer instruction (SF). Setting of I5 input results in automatic setting of T1 Timer output.
2. Time is measured after the execution of SF Timer activation instruction (trailing edge at I5 input).
3. After a time of $t=200\text{ms}$ the Q1 output state is set to low ('0') –Q1 is turned off.
4. If, during the Timer's time measurement, a high state ('1') occurs at its trigger input, the measured time counter is reset. The Timer is actuated again once a trailing edge occurs at I5 input.
5. If a high state appears at the I1 input resetting the T1, the time measuring counter and the T1 Timer will be cleared. If the "L" statement is not used, then the time to be measured by T1 will be set from the "*.set" configuration file (settings window in the PC Need program).

5.1.2.17.3. Timer SINGLE PULSE

Timer performs the function of a single pulse.

SYMBOL - **SE**

SYNTAX:

SE <T>

Instruction execution time: 8.3µs

Example:

```

A I5
L 200ms
SE T1

A T1
= Q1

A I1
R T1
    
```

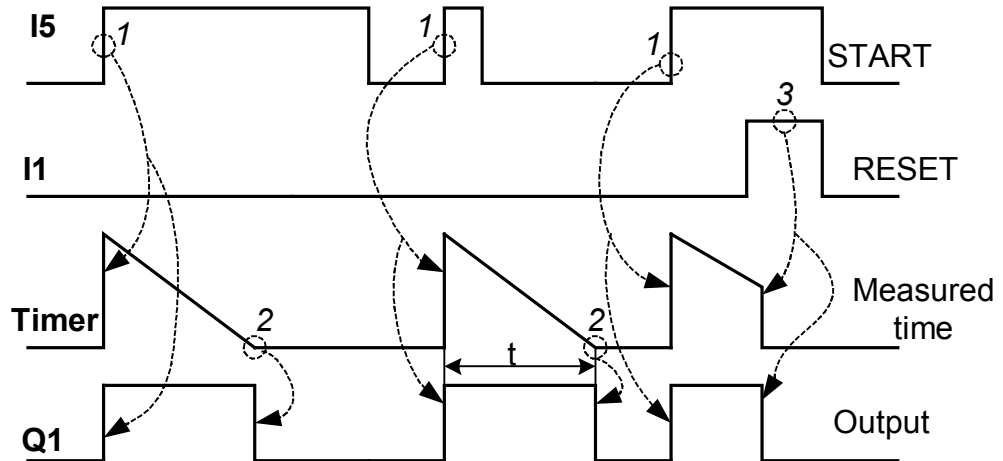

Fig. 5.1.2.17.3. Sample signal time series illustrating the operation of SE Timer.

1.

The I5 input performs the function of a triggering input (Trigger). The triggering instruction is followed by an instruction ('L') which loads the specified time value to be measured. The latter instruction should be put directly before SE Timer instruction.

Time is measured after the execution of the Timer activation instruction (leading edge at I5 input).

2.

For a period of $t=200\text{ms}$ the Q1 output state will be set to high ('1'). The state can be extended if another triggering occurs at the Trigger input. Having measured the preset time value, the Timer output returns to low state ('0') – Q1 goes to low state.

3.

If a high state appears at the I1 input resetting the T1, the time measuring counter and the T1 Timer will be cleared.

If the "L" statement is not used, then the time to be measured by T1 will be set from the "*.set" configuration file (settings window in the PC Need program).

5.1.2.17.4. Timer Pulses (FLASHING)

Timer performs the function of a square wave generator of pulse-width modulation of 50%.

SYMBOL - **SL**

SYNTAX:

SL <T>

Instruction execution time: 8.3µs

Example:

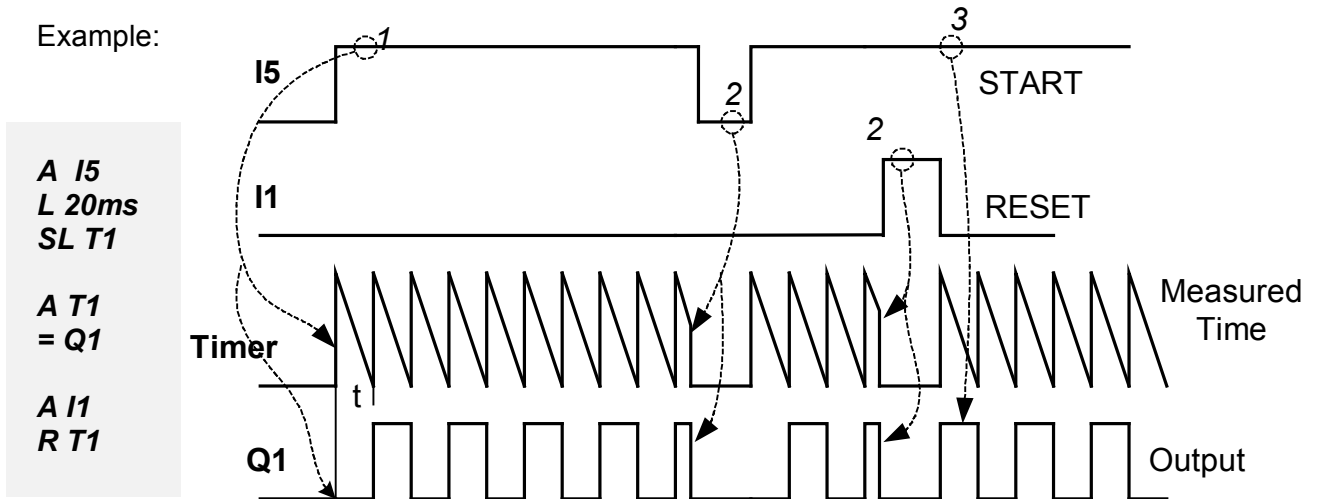

Fig.5.1.2.17.4. Sample signal time series illustrating the operation of SL Timer.

1.

The I5 input performs the function of a triggering input (Trigger). The triggering instruction is followed by an instruction which loads the specified time value to be measured. The latter instruction should be put directly before SL Timer instruction.

Time is measured after the execution of Timer activation instruction (high state '1' at the I5 triggering input).

For a period of $t=20\text{ms}$ the Q1 output state will be set to low ('0') and then, for another period of 20ms, it will be set to high ('1'). The situation will be repeated as long as the high state is present at the I5 input or until a high state occurs at the I1 resetting input.

2.

If a low state ('0') occurs at the I5 triggering input or a high state ('1') is present at the I1 resetting input, the counter of the time being measured and the Timer output are automatically reset.

3.

If high states ('1') are simultaneously sent to both Reset and Trigger inputs and if, after a certain time period, the level of Reset signal is changed to low ('0') then the Timer output is activated for a period of $t=20\text{ms}$ and, afterwards, deactivated for another period of $t=20\text{ms}$ and then again activated and so on. The Timer generates a square wave at its output, which is shifted by 180° in relation to the waveform referred to in item 1.

5.1.2.17.5. Remarks concerning use of Timers

1. The same Timer can be used many times, in different modes.

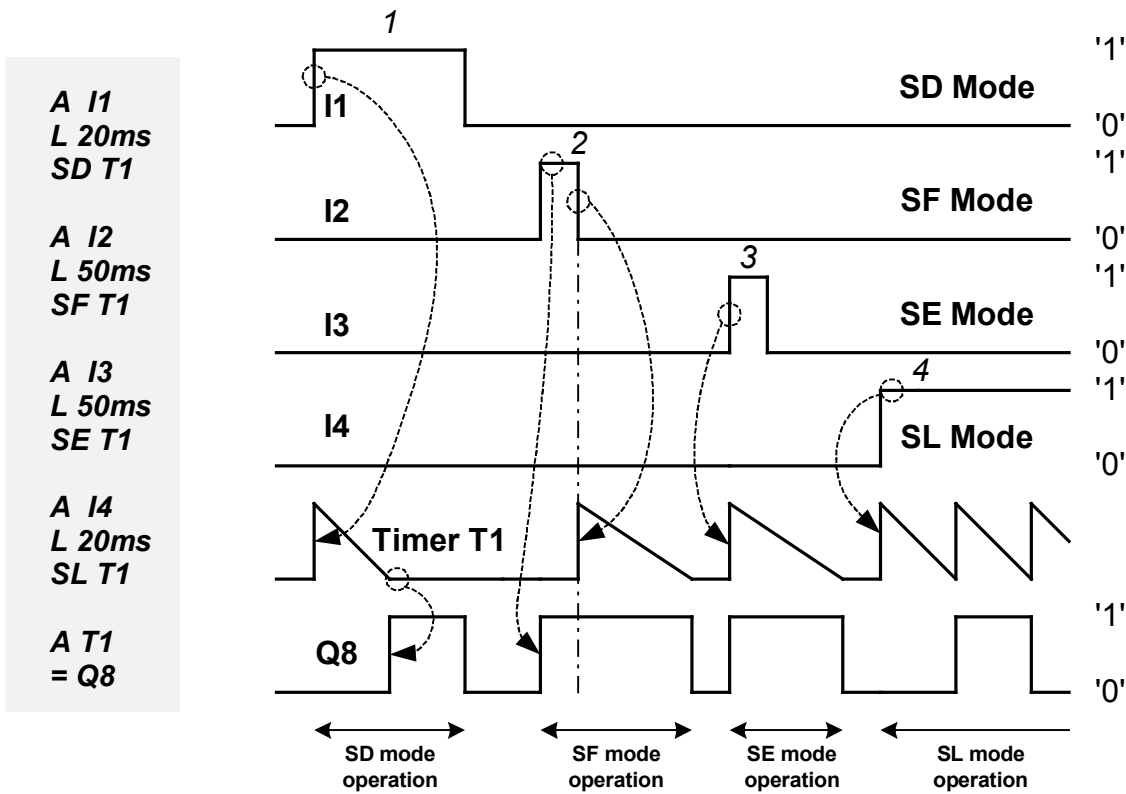

Fig. 5.1.2.17.5. Sample signal time series illustrating multiple use of T1 Timer.

If, according to the above example, the leading edge occurs at the I1 input, then T1 Timer will be triggered in SD mode, with the time of 20 ms (1).

If the trailing edge occurs at the I2 input, then the T1 Timer will be triggered in SF mode, with the time of 50 ms (2).

If leading edge occurs at the I3 input, then the T1 Timer will be triggered in SE mode, with the time of 50 ms (3).

If high state occurs at I4 input then the T1 Timer will be triggered in SL mode, with the time of 20 ms (4). Figure 5.1.2.17.5. illustrates sample time series at I1, I2, I3, I4 and Q8.

5.1.2.18. Counter instructions

5.1.2.18.1. Count-up

SYMBOL – **CU**

SYNTAX:

CU <C>

Instruction execution time: 6.1µs

Example:

```
A I5
L C#100
CU C1
```

```
A C1
=Q1
```

```
A I1
R C1
```

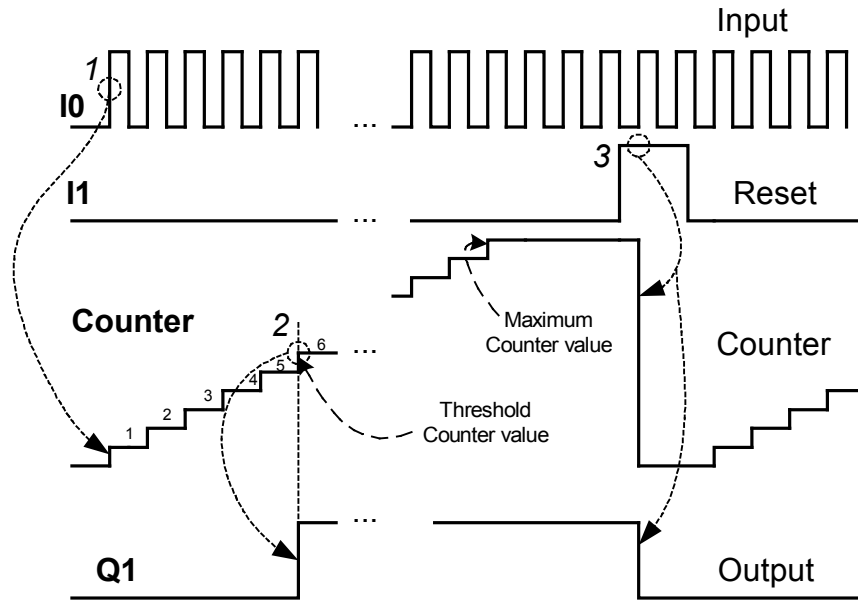

Fig. 5.1.2.18.1. Sample signal time series illustrating operation of CU Counter.

1. Occurrence of leading edge at the I5 triggering input results in the current C1 Counter value being increased by 1.
2. Once the current Counter value reaches the threshold value (6) the Q1 output state is set to high. If further pulses occur at the triggering input, they will be counted by the Counter until the maximum value of 65535 is reached, its output remaining at high state. The Counter never overflows. Once the maximum value is reached the Counter stops responding to the triggering pulses.
3. If a high state appears at the I1 resetting input – the current value of the C1 Counter and its output will be cleared. If the low state appears at this input, the Counter can keep running. If the “L” statement is not used, then the threshold value after which the C1 Counter sets its value to the high state will be based on the “*.set” configuration file (the Settings window in the PC Need program).

5.1.2.18.2. Count-down

SYMBOL – **CD**

SYNTAX:

CD <C>

Instruction execution time: 6.1µs

Example:

```

A I4
L C#100
CD C1

A C1
=Q1

A I1
R C1
    
```

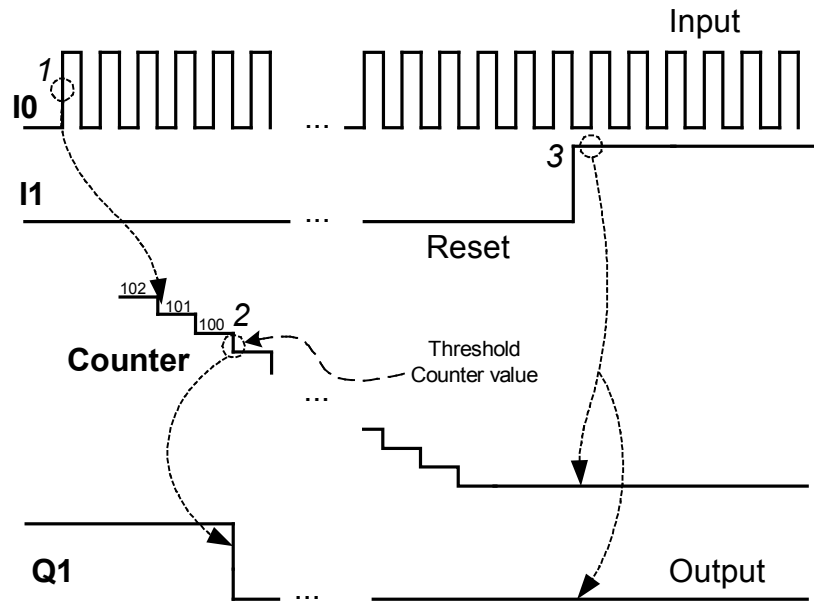

Fig.5.1.2.18.2. Sample signal time series illustrating operation of CD Counter.

1. After occurrence of a leading edge at the I4 triggering input, the current C1 Counter value will be reduced by 1.
2. Once the current value of pulse Counter goes below the threshold value (100), the Q1 output state is set to low. If further pulses occur at the I4 triggering input, they will be counted by the Counter until the minimum value of 0 is reached. The Counter never overflows. Once the minimum value is reached the Counter stops responding to the triggering pulses.
3. If a high state appears at the I1 resetting input – the current value of the C1 Counter and its output will be cleared. If the low state appears at this input, the Counter can keep running. If the “L” statement is not used, then the threshold value after which the C1 Counter sets its value to the high state will be based on the “*.set” configuration file (the Settings window in the PC Need program).



The maximum frequency of counting pulses depends on the program execution time. State of the counting input must be stable for at least one cycle of program loop.

5.1.2.18.3. Remarks on the use of Counters

1. Using the HC *Fast Counter*

To use the *Fast Counter*:

connect the *Counter* triggering signal to the I11 input.

activate the *Fast Counter* using the CU or CD statement, for example:

```
A I11
L # 25000
CU HC1
```

In the aforementioned example the *Fast Counter* will set its output to the high state, if the current value of the *Counter* is greater than or equal to 25000.

```
A I11
L # 100
CD HC1
```

In the aforementioned example the *Fast Counter* will set its output to the high state, if the current value of the *Counter* is greater than or equal to 100.

If the “L” statement is not used, then the threshold value after which the *Fast Counter* sets its output to the high state will be based on the “*.set” configuration file (the Settings window in the PC Need program).

The *Fast Counter* counts up and down. After reaching the maximum value - 65535, starts counting from zero after performing the reset function.

The *Fast Counter* can also measure the frequency – the corresponding mode of operation will be set by means of the PC Need program configuration window.



The maximum guaranteed frequency of operation of the Fast Counter is 20kHz.

Fig. 5.1.2.18.3.1. shows an example of the HC1 *Fast Counter* settings window.

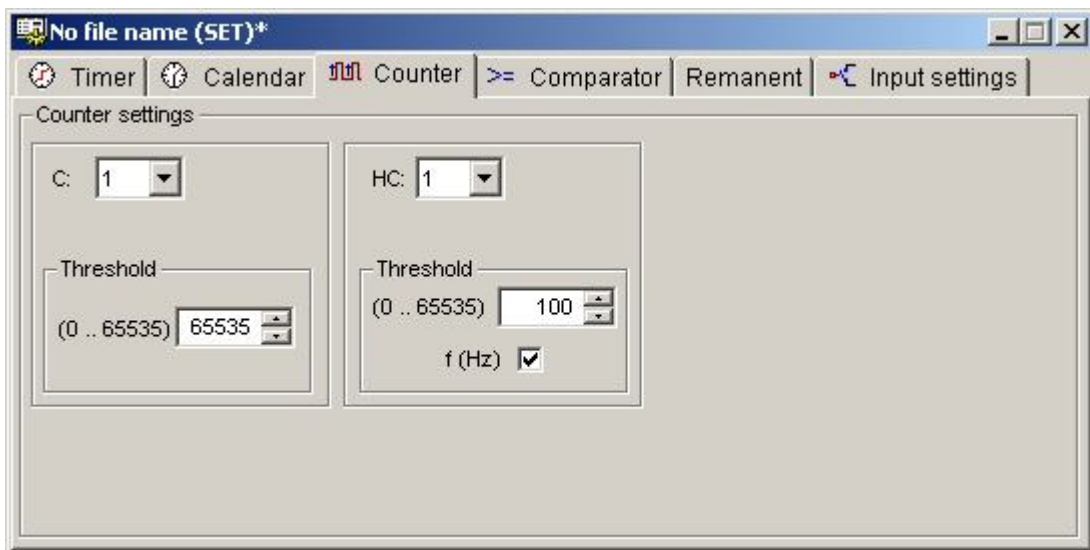

Fig. 5.1.2.18.3.1. HC1 *Fast Counter* - configuration window example.

In the aforementioned example the *Fast Counter* will set its output to the high state, if the number of pulses counted during 1 second is greater than or equal to 100.

2. One switching threshold

In order to set one threshold that switches the Counter output to high state, the same arguments (values to be counted) must be used in the *Load* instruction for both CU and CD - Fig. 5.1.2.18.3.

Leading edges that occur at M1 cause the C1 Counter to count up. If the value counted by C1 is higher than or equal to 6 then the C1 output will be set.

Leading edges that occur at A1 cause the C1 Counter to count down. If the value counted by C1 is lower than 6 then the C1 output state will be set to low.

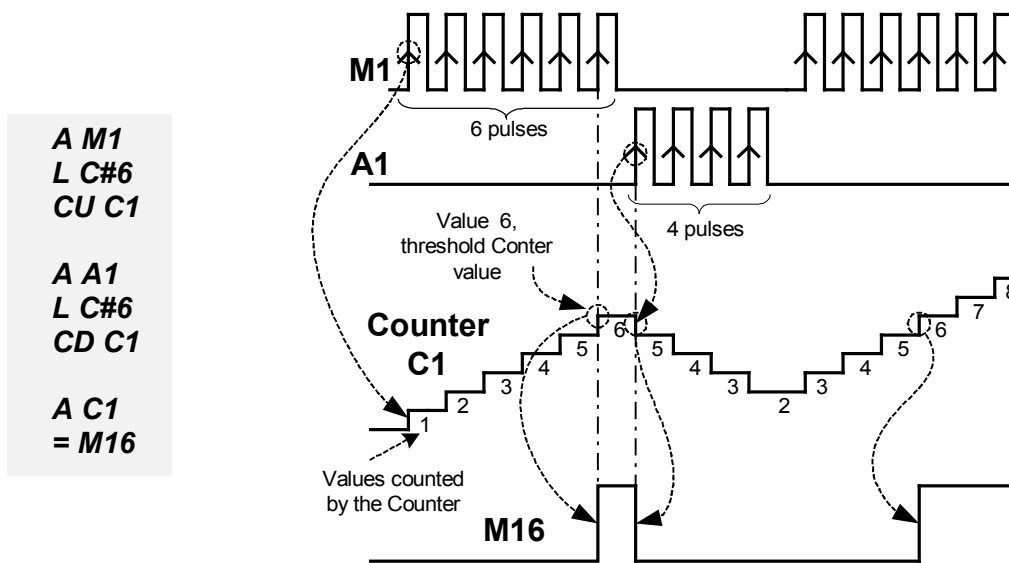

Fig. 5.1.2.18.3. Sample signal time series illustrating the Counter operation for two identical switching thresholds.

3. Two switching thresholds (range)

If the *Load* instructions of the Counters have different arguments (values to be counted) then two switching thresholds are set – Fig. 5.1.2.18.4.

Leading edges that occur at M1 cause the C1 Counter to count up. If the value counted by C1 is higher than or equal to 6 then the C1 output will be set.

Leading edges that occur at A1 cause the C1 Counter to count down. Only when the value counted by C1 is lower than 3 the C1 output state will be set to low. Thus, during count-down the C1 output state is high when the values counted by the Counter are between 6 and 3.

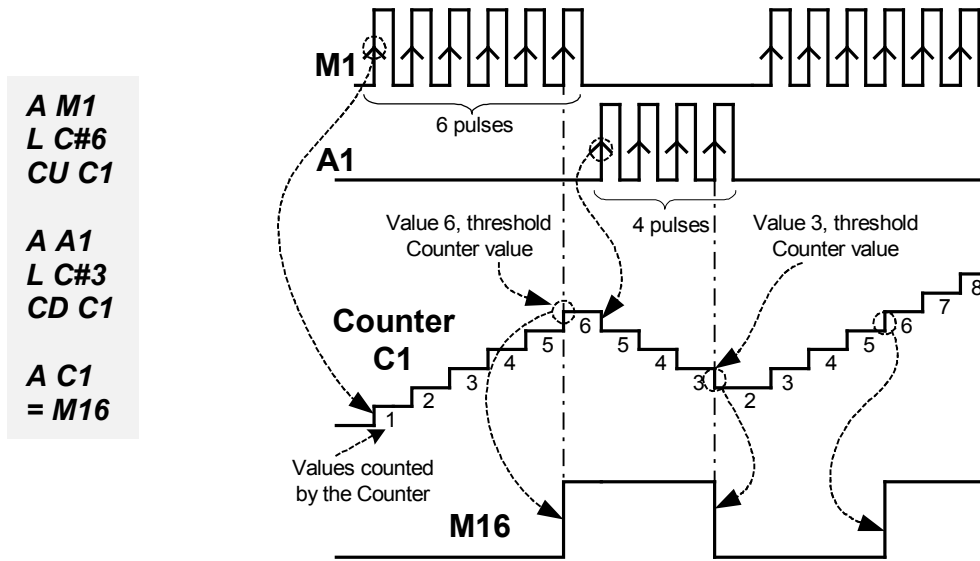

Fig. 5.1.2.18.4. Sample signal time series illustrating the Counter operation for two different switching thresholds .

4. Several switching thresholds

It is also possible to define several switching thresholds. The “always enabled” input „takes control” over the Counter and, depending on the value currently counted and the threshold set for that input, the Counter output is either set or reset – Fig. 5.1.2.18.5.

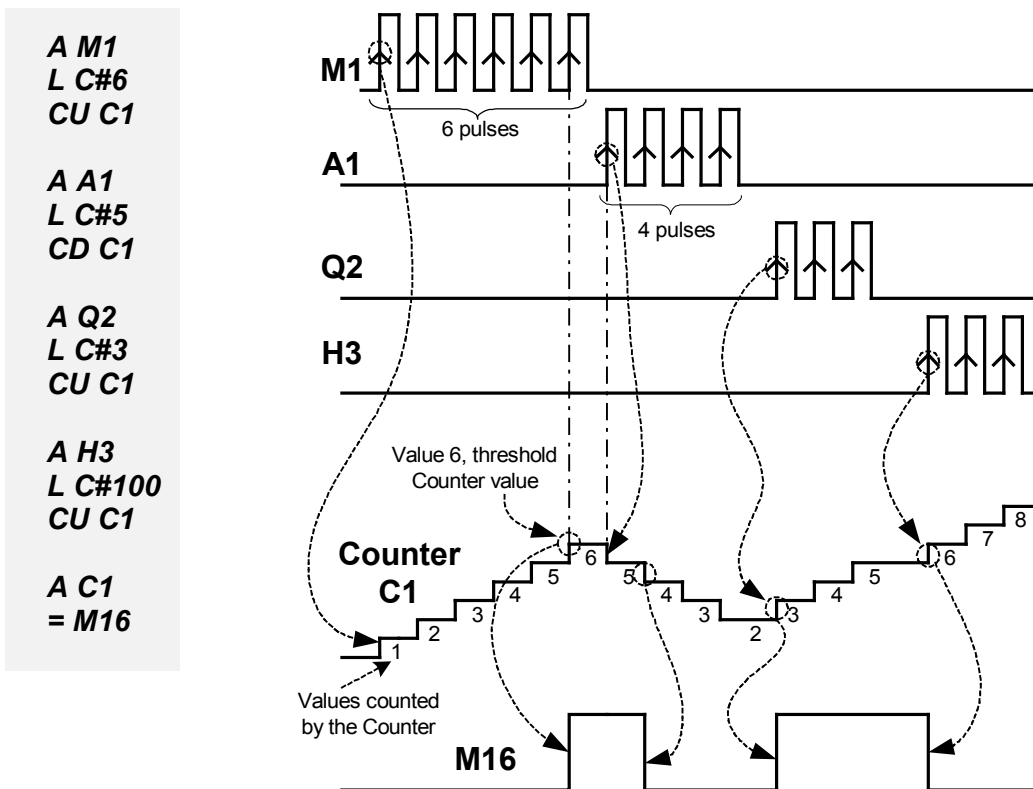

Fig.5.1.2.18.5. Sample signal time series illustrating the Counter operation for multiple different switching thresholds.

5.1.2.19. Clock instructions

The Clock is a real-time clock and its configuration should be carried out using “PC Need” application, see Chapter 6.

Detailed Clock description see Item 4.9 „Clocks”.

SYMBOL – **H**

SYNTAX:

<Conditional instructions> H <Clock number>

Example:

STL

Relay diagram

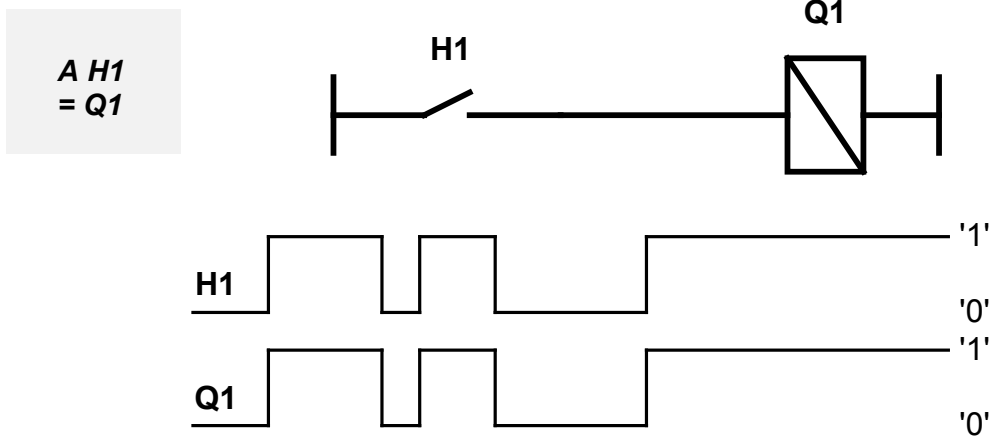

Fig. 5.1.2.19.1 Sample time series at H1 contact and Q1 output.

The H1 Clock is configured appropriately using PC Need program – see Chapter 6. Figure 5.1.2.19.2 presents a sample configuration of H1 Clock.

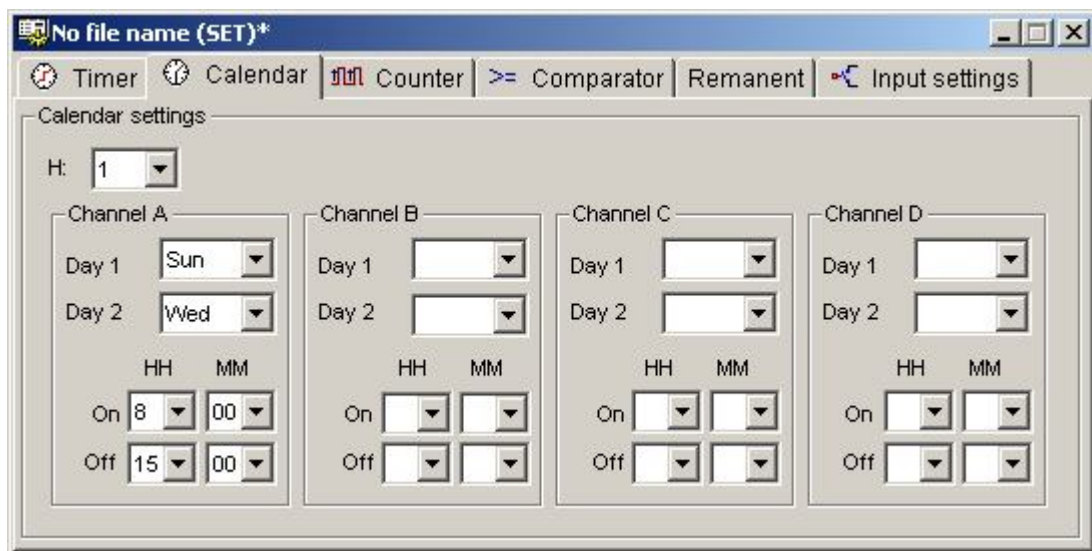

Fig. 5.1.2.19.2 Sample configuration of H1 Clock.

Q1 output will be set according to H1 Clock output state changes Sunday through Wednesday between 8 a.m. and 3 p.m.

5.1.2.20. Analogue inputs

A detailed description of analogue input function see Item 4.10 „Comparator – analogue inputs”.

SYMBOL – A

SYNTAX:

<conditional instructions> A <Comparator number>

Example:

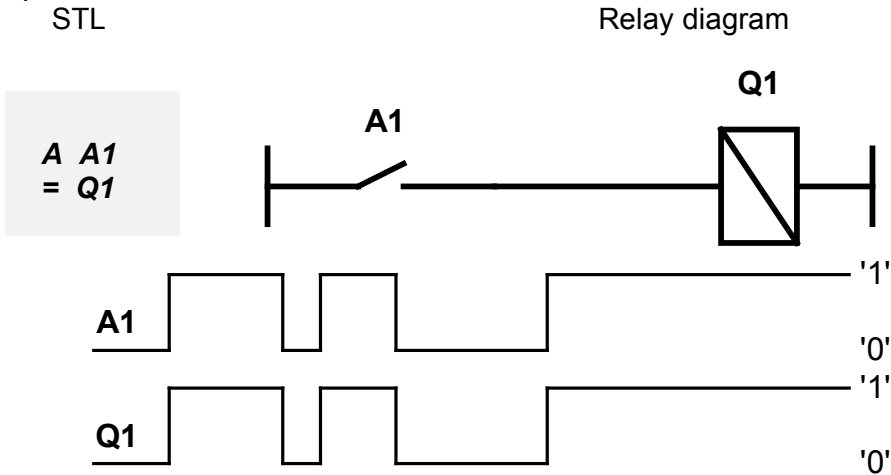

Fig. 5.1.2.20. Sample time series at A1 contact and Q1 output.

Analogue inputs are properly configured using PC Need application – see Chapter 6. Figure 5.1.2.20.2 presents a sample configuration of A1 Comparator.

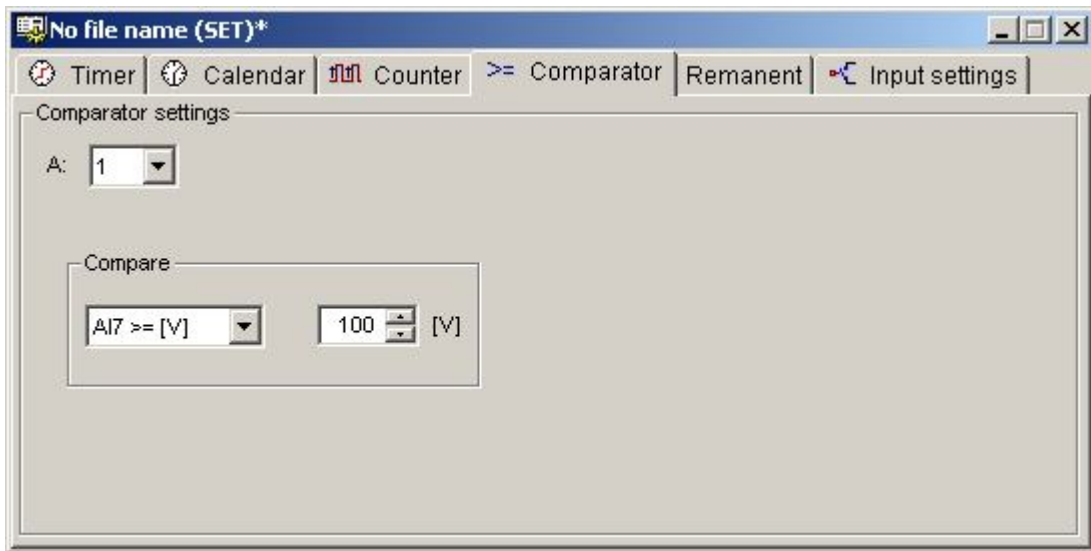

Fig. 5.1.2.20.2 Sample configuration of A1 Comparator.

The Comparator compares the preset value (100) with the analogue value at I7 input. If the voltage value at I7 input is higher than or equal to 100V the Comparator takes on the state '1', otherwise the output of the Comparator will be at the state '0'.

The Q1 output follows the changes that occur at the A1 comparator output.

5.1.2.21. Load statement (LOAD)

The 'L' statement is used for defining the *Timer* times and (counting) threshold values for *Counters*.

SYMBOL – **L**

SYNTAX:

L <value>

5.1.2.21.1. 'L' statement for Timers.

5.1.2.21.1.1. Constant time values for Timers.

Time of statement execution: 8.3µs.

The **<value>** parameter for the 'L' statement assumes the respective constant time values from the ranges given in Tab. 5.1.2.21.1. e.g.:

Table 5.1.2.21.1. shows the available time values, which can be used with the 'L' statement.

Table .5.1.2.21.1. 'L' statement arguments for Timers.

Time format	Range	Step	Examples of values
s.ms (seconds.milliseconds)	0s.10ms – 99s.990ms	10ms	0.50ms, 24s, 50s.120ms
min.s (minutes.seconds)	0min.1s – 99min.59s	1s	2min, 32min, 98min.24s
h.min (hours.minutes)	0h.1min – 99h.59min	1min	1h, 5h.18min

```
L 100ms //The value of 100ms will be loaded into the T1 Timer running in the SL mode
SL T1
```

```
L 10min //The value of 10 min will be loaded into the T2 Timer running in the SD mode
SD T2
```

```
L 1h.34min //Timer T8 running in the SF mode will be loaded with
SF T8 //1h.34min
```

5.1.2.21.1.2. Time values for Timers based on the Potentiometer setting

Time of statement execution: 10.3µs.

You can also use the value read from the Potentiometer as the time to be measured by *Timers*, then the **<value>** argument of the 'L' statement can take the following values (please refer to Table 5.1.2.21.2.):

1. x10ms

```
L Pot x10ms //Time to be measured = current Potentiometer value (1 – 255)x10ms,
//e.g. when the Potentiometer set value = 25, then the time to be measured =
//25x10ms = 250ms.
```

2. x100ms

```
L Pot x100ms //Time to be measured = current Potentiometer value (1 – 255)x100ms,
//e.g. when the Potentiometer set value = 15, then the time to be measured =
//15x100ms = 1500ms = 1.5s
```

3. x1s

```
L Pot x1s //Time to be measured = current Potentiometer value (1 – 255)x1s,
//e.g. when the Potentiometer set value = 10, then the time to be measured =
//10x1s = 10s
```

4. x10s

```
L Pot x10s //Time to be measured = current Potentiometer value (1 – 255)x10s,
//e.g. when the Potentiometer set value = 8, then the time to be measured =
//8x10s = 80s
```

5. x1min

```
L Pot x1min //Time to be measured = current Potentiometer value (1 – 255)x1min,
//e.g. when the Potentiometer set value = 255, then the time to be measured =
//255x1min = 255min
```

Tab.5.1.2.21.1.2. 'L' statement arguments for Timers obtained through Potentiometer settings.

Potentiometer range	Multiplier	Time range
1 – 255	x 10ms	10ms – 2.55s
	x 100ms	100ms – 25.50s
	x 1s	1s – 4min15s
	x 10s	10s – 42min30s
	x 1min	1min – 255min0s

5.1.2.21.1.3. Time values for *Timers* based on the voltage values on analog voltage inputs

Time of statement execution: 10,3µs.



For measuring time for *Timers*, it is possible to use the values of voltages read from the I7, I8 analog inputs in the NEED-12DC-...-08-4, NEED-24DC-...-08-4 version or I14, I15, I16 in the NEED-12DC-...-16-8, NEED-24DC-...-16-8 version.

For the analog voltage inputs the **<value>** argument of the 'L' statement can take the time values presented in the 5.1.2.21.1.3. Table

Tab.5.1.2.21.1.3. The 'L' statement arguments for Timers obtained by reading the analog inputs in voltage mode.

The voltage range measured on the analog input [V]	Range multiplier	General multiplier	Time range
0.10 – 25.50 (in 0.10 steps)	x 10ms	x 10	10ms – 2s550ms
	x 100ms		100ms – 25s500ms
	x 1s		1s – 4min15s
	x 10s		10s – 42min30s
	x 1min		1min – 255min0s
0.05 – 12.75 (in 0.05 steps)	x 10ms	x 20	10ms – 2s550ms
	x 100ms		100ms – 25s500s
	x 1s		1s – 4min15s
	x 10s		10s – 42min30s
	x 1min		1min – 255min0s

The time measured for the NEED-24DC-..., NEED-12DC-.. relays is calculated as follows:

Voltage values on the analog input [V] x range multiplier x general multiplier = measured time

In the STL language syntax the **AI7** or **AI8** symbols are used for NEED-12DC-..-08-4, NEED-24DC-..-08-4 or **AI14**, **AI15**, **AI16** for NEED-12DC-..-16-8, NEED-24DC-..-16-8, for example:

```
L AI7 x1min //Time to be measured = current voltage value at the analog input
//AI7[V] x 1min x 10,
//e.g. voltage value on the AI7 analog input = 20V,
//time to be measured = 20 x 1min x 10 = 20min x 10 = 200min
```

```
L AI14 x100ms //Time to be measured = current voltage value at the analog input
//input AI14[V] (range 0.05V - 12.75V) x 100ms x 20,
//e.g. AI14 analog voltage value = 10V,
//time to be measured = 10V x 100ms x 20 = 1000ms x 20 = 20s
```



Increased resolution of analog inputs (operating range 0.05V – 12.75V) can be used only for the NEED-12DC-..-16-8 or NEED-24DC-..-16-8 relays.

5.1.2.21.1.4. Time values for Timers based on the current values on current analog inputs

Time of statement execution: 10,3µs.

For current analog inputs (only for NEED-12DC-..-16-8, NEED-24DC-..-16-8) the **<value>** argument of the 'L' statement can take the time values presented in the 5.1.2.21.1.4 Table.

Table 5.1.2.21.1.4. The 'L' statement arguments for Timers obtained by reading the analog inputs in the current mode.

The current range measured on the analog input [mA]	Range multiplier	General multiplier	Time range
0.2 – 51.0 (in 0.2 steps)	x 10ms	x 5	10ms – 2s550ms
	x 100ms		100ms – 25s500ms
	x 1s		1s – 4min15s
	x 10s		10s – 42min30s
	x 1min		1min – 255min0s
0.1 – 25.50 (in 0.1 steps)	x 10ms	x 10	10ms – 2s550ms
	x 100ms		100ms – 25s500s
	x 1s		1s – 4min15s
	x 10s		10s – 42min30s
	x 1min		1min – 255min0s

The time measured for the NEED-24DC-.-16-8, NEED-12DC-.-16-8 relays is calculated as follows:

The current values on the analog input [mA] x range multiplier x general multiplier = measured time

L AI16 x1min //time to be measured = present current value in [mA] (range 0.2 – 51) x //1min x 5
 //e.g. AI16 current value = 10mA
 // the time to be measured = 10mA x 1min x 5 = 10minx5=50min

L AI14 x1s //time to be measured = present current value in [mA] (range 0.1 – 25.5) x 10
 //e.g. AI16 current value = 5mA
 //time to be measured = 5mA x 1s x 10 = 5s x 10 = 50s



Increased resolution of analog inputs (operating range 0.10mA – 25.50mA) can be used only for the NEED-12DC-.-16-8 or NEED-24DC-.-16-8 relays.

5.1.2.21.2. 'L' statement for Counters.

5.1.2.21.2.1. Constant threshold values for counters

Time of statement execution: 8.3µs

The **<value>** parameter of the 'L' statement takes the corresponding constant values for Counters from the range of 0–65535 e.g.:

L C#10
CU C1 //Setting of value 10 to be counted by the C1 up counter

L C#1000
CD C8 //Setting of value 1000 to be counted by the C8 down counter

5.1.2.21.2.2. Threshold values for counters, defined according to the Potentiometer setting

Time of statement execution: 10.3µs.

You can also use the value read from the Potentiometer as the set value to be counted by the *Counters*, then the 'L' statement format can take the following value:

1.

```
L Pot x1 //value to be counted from the (1 – 255)x1 range (e.g. the Potentiometer's
CU C1 //value is set to 23 – then the value to be counted by C1 is
//equal to 23x1=23)
```

2.

```
L Pot x10 // value to be counted from the (10 – 255)x1 range (e.g. the Potentiometer's
CD C2 //value is set to 23 – then the value to be counted by C2 is
//equal to 23x10=230)
```

3.

```
L Pot x100 // value to be counted from the (1 – 255)x100 range (e.g. the Potentiometer's
//value is set to 23 – then the value to be counted by C3 is
//equal to 23x100=2300)
```

Table 5.1.2.21.2.1. 'L' statement arguments for Counters obtained through Potentiometer settings.

Potentiometer range	Range multiplier	Number range
1 – 255	X 1	1 – 255
	X 10	10 – 2550
	x 100	100 – 25500

5.1.2.21.2.3. Threshold values for *Counters* based on the voltage values on analog voltage inputs

Time of statement execution: 10.3µs.



For setting thresholds for the *Counter* it is possible to use the values of voltages read from the I7, I8 analog inputs in the NEED-12DC-...-08-4, NEED-24DC-...-08-4 version or I14, I15, I16 in the NEED-12DC-...-16-8, NEED-24DC-...-16-8 version. In this case the **<value>** argument of the 'L' statement can take the threshold values shown in the Table no. 5.1.2.21.2.3.

Table 5.1.2.21.2.3. The 'L' statement arguments for Counters obtained by reading the analog inputs.

The voltage range on the analog input [V]	Range multiplier	General multiplier	Number range
0.1 – 25.5 (in 0.1 steps)	x 1	x 10	1– 255
	x 10		10 – 2550
	x 100		100 – 25500
0.05 – 12.75 (in 0.1 steps)	x 1	x 20	1– 255
	x 10		10 – 2550
	x 100		100 – 25500

The threshold set for the NEED-24DC-..., NEED-12DC-.. relays is calculated as follows:

Voltage values on the analog input [V] x range multiplier x general multiplier = Counter threshold

In the STL language syntax the **AI7** or **AI8** symbols are used for NEED-12DC-...-08-4, NEED-24DC-...-08-4 or **AI14**, **AI15**, **AI16** for NEED-12DC-...-16-8, NEED-24DC-...-16-8, for example:

```
L AI7 x100 //Value to be counted = current voltage value at the analog input
//((range: 0.1V – 25.5V) AI7[V] x 100 x 10,
//e.g.. voltage value at AI7=10V
//value to be counted = 10V x 100 x 10 = 10V x 1000 = 10 000

L AI15 x10 //Value to be counted = current voltage value at the analog input
//((range: 0.05V – 12.75V) AI15[V] x 10 x 20,
//e.g. AI15 analog voltage value = 1V,
//value to be counted = 1V x 10 x 20 = 1V x 200 = 200
```



Increased resolution of analog inputs (operating range 0.05V – 12.75V) can be used only for the NEED-12DC-...-16-8 or NEED-24DC-...-16-8 relays.

5.1.2.21.2.4. Threshold values for *Counters* based on the voltage values on current analog inputs

Time of statement execution: 10.3µs.



For setting thresholds for the *Counter* it is possible to use the values of currents read from the I14, I15, I16 analog inputs in the NEED-12DC-...-16-8, or NEED-24DC-...-16-8. In this case the **<value>** argument of the 'L' statement can take the threshold values shown in the Table no. 5.1.2.21.2.4.

Table 5.1.2.21.2.4. The 'L' statement arguments for Counters obtained by reading the analog inputs.

The current range on the analog input [mA]	Range multiplier	General multiplier	Number range
0.2 – 51.0 (in 0.2 steps)	x 1	x 5	10 – 255
	x 10		100 – 2550
	x 100		1000 – 25500
0.1 – 25.5 (in 0.1 steps)	x 1	x 10	10 – 255
	x 10		100 – 2550
	x 100		1000 – 25500

The threshold set for the NEED-24DC-..., NEED-12DC-.. relays is calculated as follows:

The current values on the analog input [mA] x range multiplier x general multiplier = Counter threshold

```
L AI16 x100 //Value to be counted = present current value at the analog input
//((range 0.2mA – 51mA) AI16 [mA] x 100 x 5,
//e.g. AI16 current value = 1mA
//value to be counted = 1mA x 100 x 5 = 1mA x 500 = 500
```

```
L AI15 x10 //Value to be counted = current voltage value at the analog input
// (range: 0.1mA – 25.5mA) AI15[mA] x 10 x 10,
//e.g. AI15 current value = 10mA
//value to be counted = 10mA x 10 x 10 = 10mA x 100 = 1000
```



Increased resolution of analog inputs (operating range 0.10mA – 25.50mA) can be used only for the NEED-12DC-..-16-8 or NEED-24DC-..-16-8 relays.

Examples of use of the 'L' statement.

```
A I5
L 20s
SF T1

A I5
L C#10
CU C8

A I8
L Pot x1s
SE T2

A I5
L AI16 x10
CU C1
```

A 20s value will be loaded into the T1 *Timer* .

A fixed threshold value of 10 is set for the C8 *Counter* C8, toggling its output state from low

(‘0’) to high (‘1’).

The T2 *Timer* will be loaded with the Potentiometer value multiplied by 1s
 For the C1 *Counter* a threshold value is set by means of the analog value present on AI16, multiplied by 10 (range multiplier 0.1 – 25.5V) x 10 (general multiplier), toggling its output state from (‘0’) to high (‘1’).

5.1.2.21.3. Remarks concerning the use of ‘L’ instruction

1. If no *Load* statement was performed in the program, then the time values measured by *Timers* and the threshold values for *Counters* are defined in the PC Need program, in the “*.set” configuration file, e.g.:

```
A I3
SE T2

A I5
CD C2
```

In the example above the T2 *Timer* will measure the time of 1s, set in the PC Need program, whereas the *Counter* will set/clear its output at the threshold of 21. The following configurations are set in fig. 5.1.2.21.3.1. and fig. 5.1.2.21.3.2.

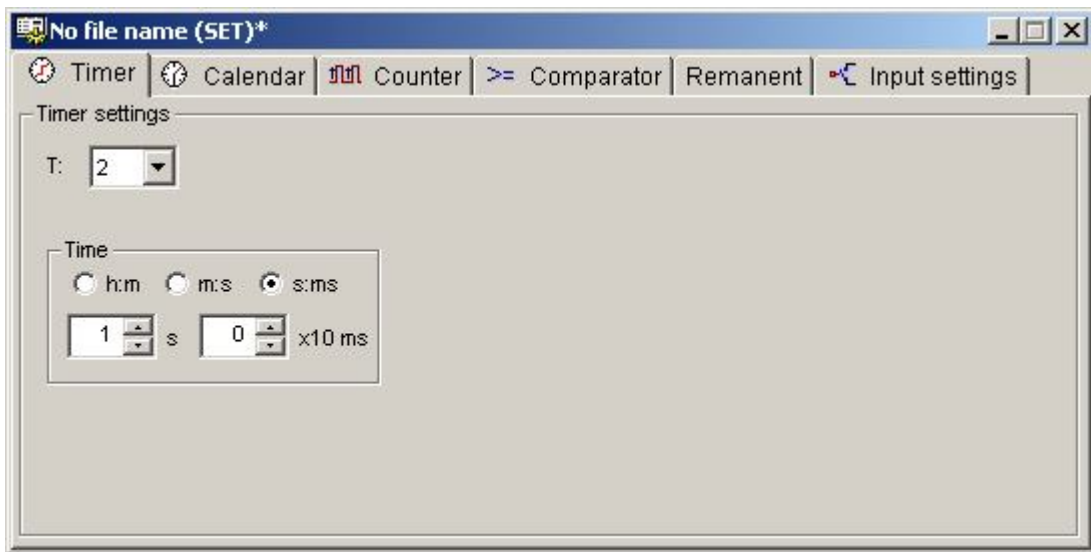

Fig. 5.1.2.21.3.1. Time setting for T2 Timer.

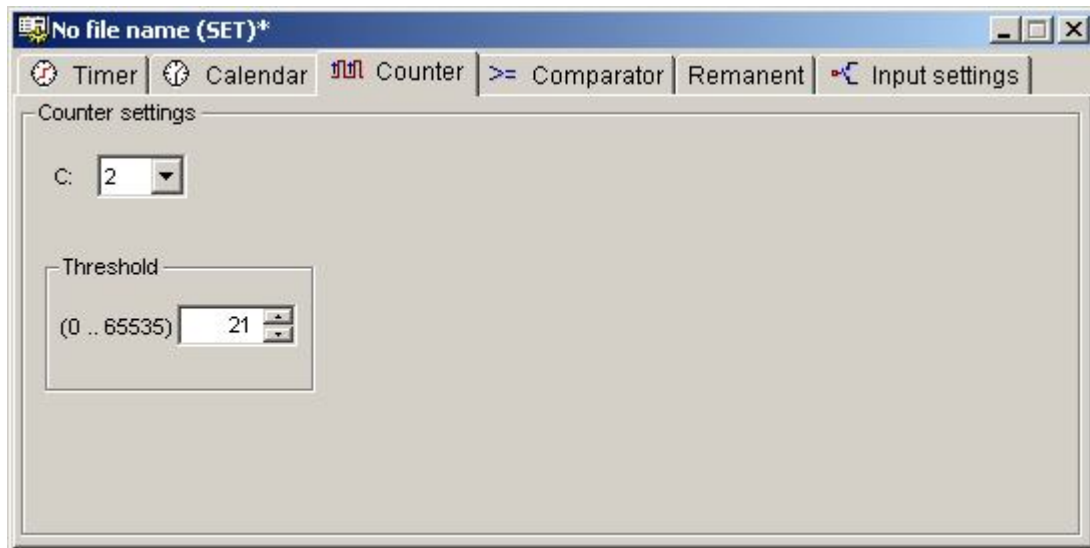

Fig. 5.1.2.21.3.2. Time setting for C2 Counter.

2. If a *Load* statement was performed in the program, then all time values to be measured by *Timers* and values to be counted by *Counters* are defined by this statement.

A I3
SE T2

A I8
L 1min
SE T3

A I8
SE T4

In the example above triggering of the T2 *Timer* with the ramp-up on the I3 input will cause T2 to measure the time set in the PC Need program, in the configuration file. If a rising edge appears at the I8 input, then the T3 *Timer* will measure the time defined in the *Load* statement – 1min, and the T4 *Timer* will measure the time set in the “*.set” settings file.

5.1.2.22. “Always setting” instruction SET

‘SET’ instruction permanently sets the state to high ‘1’.

SYMBOL – **SET**

SYNTAX:

SET

Instruction execution time: 8.9µs

‘SET’ instruction is unconditional (always executed), and it permanently sets the logical state of ‘1’ in the conditional part of the circuit.

Example:

SET
= Q4
SL T1
S M16

Upon execution of that instruction Q4 output and M16 Marker will be permanently set to high state '1' while the T1 Timer will be permanently released to operate in the pulse generator mode.

5.1.2.23. "Always clearing" instruction CLR

'CLR' instruction permanently sets the state to low '0'.

SYMBOL – **CLR**

SYNTAX:

CLR

Instruction execution time: 8.9µs

'CLR' instruction is unconditional (always executed), and it permanently sets the logical state of '0' in the conditional part of the circuit.

Example:

```
CLR  
=Q4  
=M1  
SL T1
```

Upon execution of the 'CLR' instruction M1 Marker and Q1 output will be permanently set to low state '0' while T1 Timer will never be started.

5.2. Programming in LAD graphic language

LAD (*Ladder Diagram*) is a simple programming method used to edit PLC programs. As the basic language standard principles are maintained, the application of that language should cause no problems to users who are familiar with a similar programming method. First time users of NEED relays will be able to learn and use a programming method based on drawing electrical connection diagrams.

5.2.1. Symbols in LAD.

Ladder diagram language (LAD) is based on symbols of contact and relay logics. It enables representation of contacts (input elements), two-state outputs (reflecting the relay coils) and function outputs.

Basic LAD language symbols to represent the inputs are presented in Fig. 5.2.1.1.

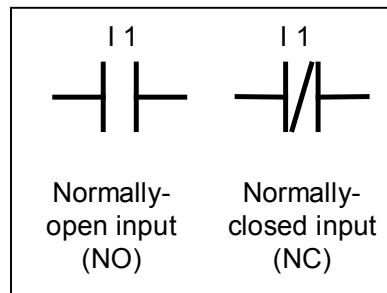

Fig. 5.2.1.1. Basic LAD language elements- inputs.

Functional outputs are Timers - Fig. 5.2.1.2. and Counters – Fig. 5.2.1.3.

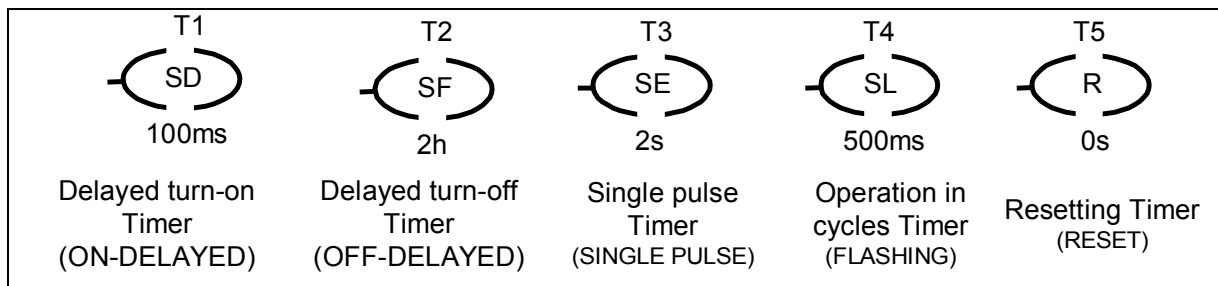

Fig.5.2.1.2. LAD language elements – Timers.

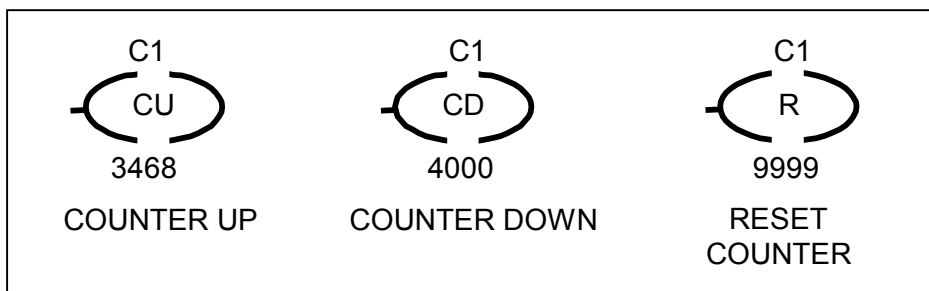

Fig. 5.2.1.3. LAD language elements - Counters.

LAD language symbols to represent outputs are presented in Fig. 5.2.1.4.

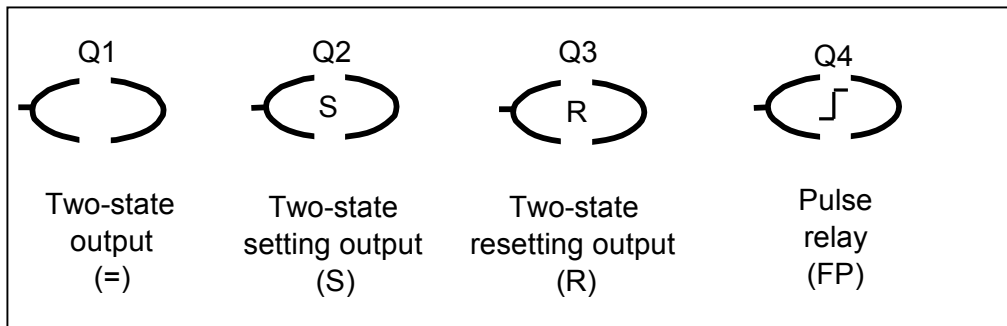

Fig.5.2.1.4. LAD language elements – outputs.

LAD language symbols to represent Markers are presented in Fig. 5.2.1.5.

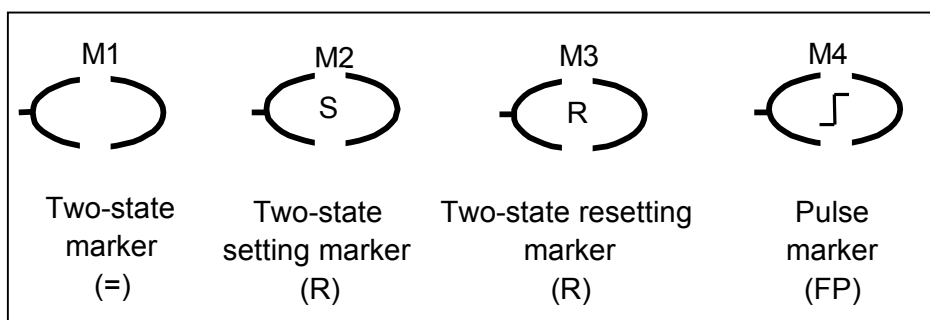

Fig.5.2.1.5. LAD language elements – Markers.

5.2.2. Inputs

From the point of view of the LAD program, not only a physical contact of an electric device (discrete input) can be an input but also a state (logical level) of Timer, Counter, Clock, Marker or even output. Since those elements, during their operation, are assigned two-state values ('0' or '1') it is possible to check them and make the operation of other circuit components dependent on them.



Note: Output check consists only in acquiring program information on the state of the register which controls that physical output. That means that the efficiency of the relay and of execution system of the output are not taken into account.

5.2.3. Outputs

The simplest arrangement involves a two-state element such as a relay with powered or unpowered coil. In such a case the relay is active if the relay coil is powered, i.e. a specific logical state is assumed for it. Our case employs a "positive" logics which means that the state '1' represents an active output while the inactive output is that of the logical state '0'. Depending on the function assigned (see Table 5.2.6.) an output may be set to be continuously dependent on the outputs ('=' instruction) which is analogous to an active relay, if the coil is powered. Functioning of both SET and RESET outputs is different as, once the conditions are met, the logical state '1' is set permanently ('S' instruction). Such a state is maintained until a resetting operation (R) is executed which is corresponding to the functioning of a backed-up relay.

LAD outputs also do not need to have corresponding physical outputs in the relay structure, they are so-called functional outputs which enable the use of such elements as Timer, Counter, Clock, Marker. The elements are set similarly to physical outputs (they take on state '0' or '1') depending on functions assigned to them (see Table 5.2.6.).

5.2.4. LAD program structure

Symbols are placed in networks. Networks are placed in a ladder in a rung-like manner. Successive networks (ladder rungs) are read one by one from the top to the bottom. After the last rung has been reached the program tracking process is started from the beginning. The network is limited on the left and right by current rails. The right rail may be either visible or invisible. Due to analogy to relay diagram, LAD programs can be read as the passage of current from the left vertical line to the right (e.g. left side being the power supply, right side being the ground potential) through individual networks.

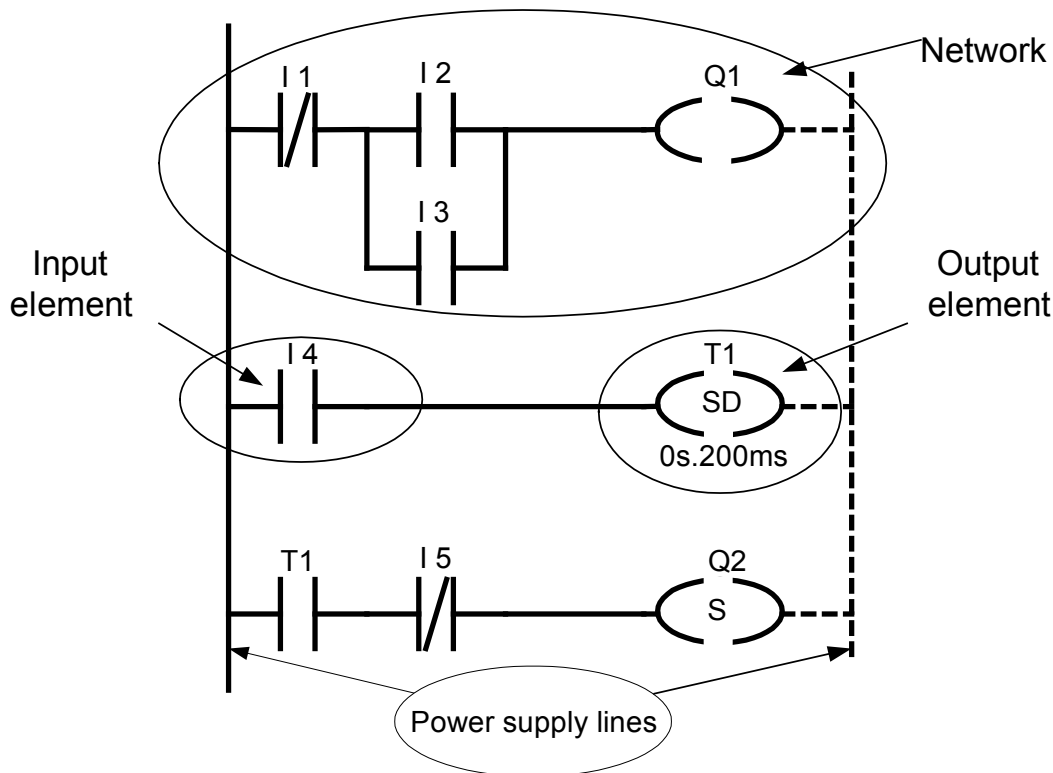

Fig. 5.2.3. Sample application in LAD language

5.2.5. LAD network structure.

Network must have appropriate format and syntax. Below please find several main principles:

- each network may have up to 16 parallel lines, each line may have up to 4 logical elements connected in series,
- the last element of the series connection in the network must be one of the executive elements (two-state output or function output),
- network can have maximum 16 output elements,
- network must have at least one contact (input) upstream the execution element (output) or vertical connection,
- there must be no branch having its beginning or end within another branch, which is connected with the "supply line" or outputs

Sample prohibited connections are presented below:

- No output element

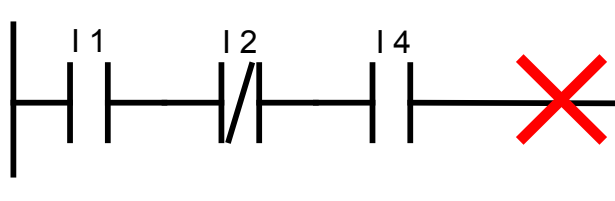

- Branch within another network the end (or beginning) of which is connected with „supply line” or outputs (in the example below the Q4 output must not be connected to the I3 and I5 branches).

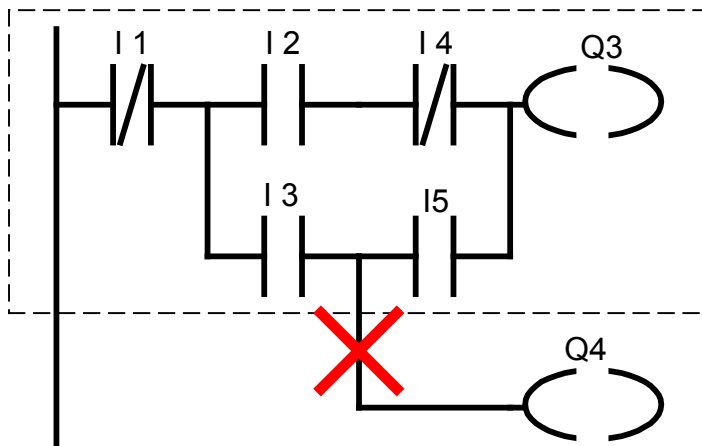

5.2.6. Description of elements used.

The logical element (symbol – see Table 5.2.6), which performs the function of a signal input or output in the LAD language can be assigned different variables i.e. the signal input can be not only the voltage supplied to hardware inputs (designated as I1..I8) but also the state of Timer, Counter, Clock or output. The assignment is made according to the description on the element symbol. The designation digit is the number of input to be checked. Similarly, not only the physical inputs but also Markers (outputs without physical leads) and states of Timers, Counters etc. can be set. Symbols of the LAD language including description and permissible signal XY variables for the specific element (X – input, Y – output) are presented in Table 5.2.6.

Active input – an input the state of which allows signal flow (logical ‘1’ for the NO input, logical ‘0’ for the NC input)

Active output – an output the logical signal of which is ‘1’.

Table 5.2.6. Basic symbols of LAD language.

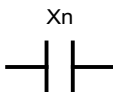
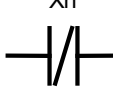
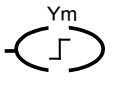
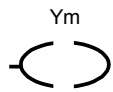
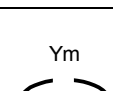
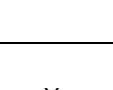
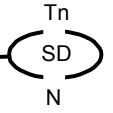
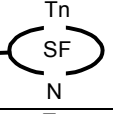
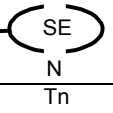
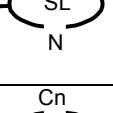
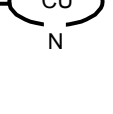
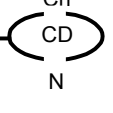
LAD	Description	Variable
	Normally open input. Active input (contact closed), when the logical value of the variable assigned is '1'.	X: I,A,H Q,M, T, C, n: number of possible inputs of a specific type
	Normally closed input. Active input (contact open), when the logical value of the variable assigned is '0'.	
	Pulse relay – performs the function of a flip-flop triggered by the leading edge. Each leading pulse changes the output state to opposite. (FP)	Y: Q, M m: number of the outputs of the specific type
	Assigning output Sets the value of the assigned variable to '1' when the signal is applied to the output. Equivalent of an open-contact relay (copying of the input state to the output)	Y: Q, M m: number of the output of the specific type
	Set output Sets the value of the assigned variable to '1' when the signal is applied to the output and maintains the state until "Reset" instruction is executed or the programmable relay is powered off (backed-up relay).	Y: Q, M m: number of the output of the specific type
	Reset output Sets the value of the assigned variable to '0' when the signal is applied to the output and maintains the state until "Set" (S-STL) instruction is executed or the programmable relay power supply is cut off (output resetting).	
	Delayed turn-on Timer Sets the value of Tn = '1' after the preset time „N” has elapsed counted from the time of activation.	T n: number of Timer
	Delayed turn-off Timer Maintains the value of Tn = '1' for the preset time „N” after the activation signal has ceased.	
	Single pulse Timer After activation a single pulse is generated of the duration of „N”.	
	Pulse Timer If active, a square wave is generated (pulses) with pulse-width modulation of 50% (pulse high state duration time „N” and low state duration time „N”).	
	Counter up Pulses are counted on activation – Counter state is increased at the input assigned to the specific Counter. After the current Counter has reached the threshold of „N” the Counter state goes to '1'.	C, HC n: number of Counter
	Counter down Pulses are counted on activation – Counter state is decreased at the input assigned to the specific Counter. After the current Counter value has gone below the threshold of „N” the Counter state goes to '1'.	

5.2.7. Configuration

5.2.7.1. Configuration of inputs

Each input in the program (network) must be assigned a type and a variable. The type is assigned in a graphic manner – by selecting the normally open or normally closed contact, the variable is placed above the graphic symbol. The variable which defines the input type is composed of a letter designation and a number.

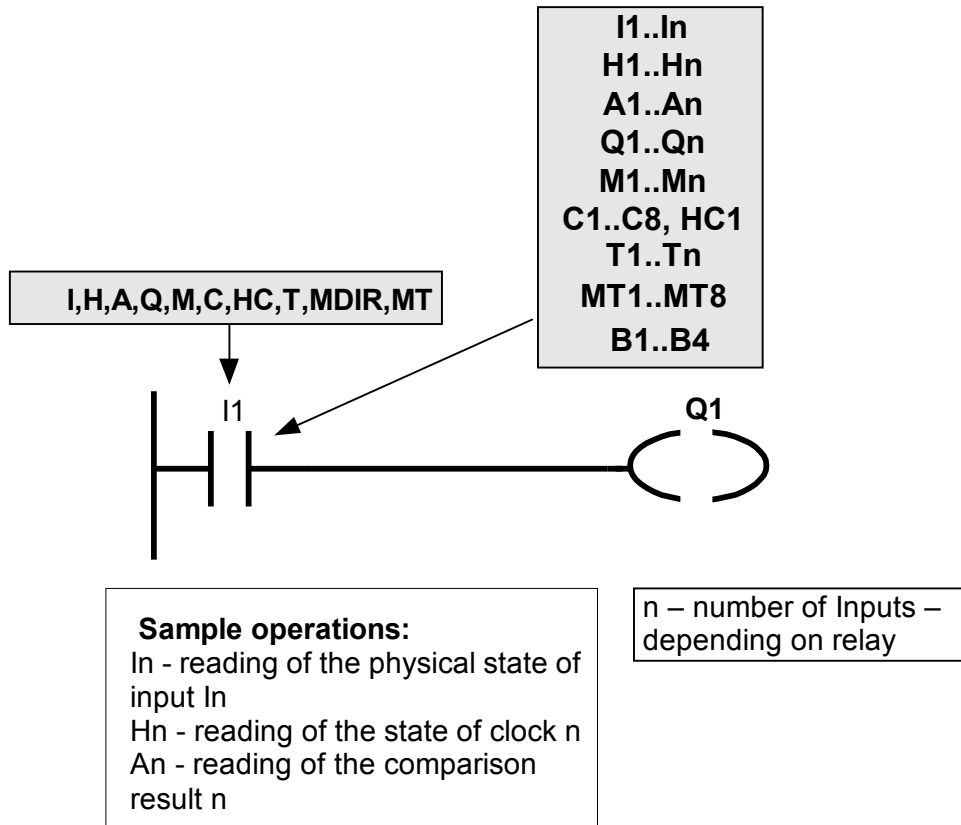

Fig. 5.2.7.1. Configuration of inputs.

The following variables are available:

- I - inputs,
- H - Clocks,
- A – analogue comparisons,
- Q – states of outputs,
- M – states of Markers,
- C – states of Counters,
- T – states of Timers.
- HC – fast meter/gauge of frequencies 0-20 kHz.
- MDIR – system phase direction marker
- MT – Text Markers
- B - Buttons

5.2.7.2. Configuration of outputs

Physical outputs are presented using graphic symbols illustrated in Fig. 5.2.7.2. Expected output behavior determines the graphic symbol to be used. Above the graphic symbol the letter Q is put which designates the output and its number.

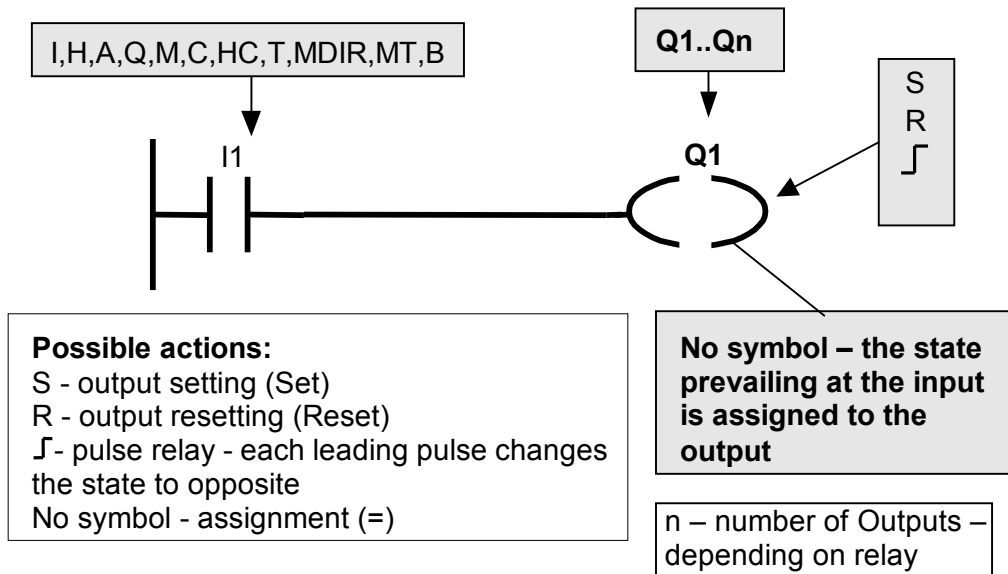

Fig. 5.2.7.2. Configuration of outputs

5.2.7.3. Configuration of Markers

Markers, just like the outputs, are presented using the same graphic symbol by replacing Q with M (as illustrated in Fig. 5.2.7.3).

Expected Marker behavior determines the graphic symbol to be used inside the graphic designation of the Marker. Above the graphic symbol the letter M is put which designates the Marker, and its number

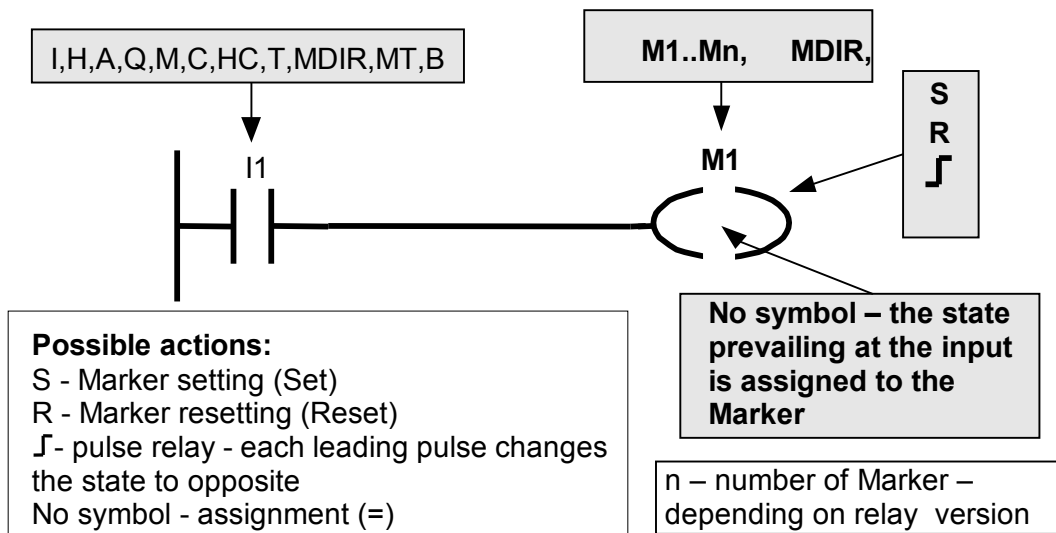

Fig. 5.2.7.3. Configuration of Markers.

5.2.7.4. Configuration of Timers

Timers are presented using the same graphic symbols which are used for outputs – see Fig. 5.2.7.4.

Expected Timer operation determines the symbol to be used inside the graphic designation of the Timer. A letter T and a Timer number are put above the graphic symbol.

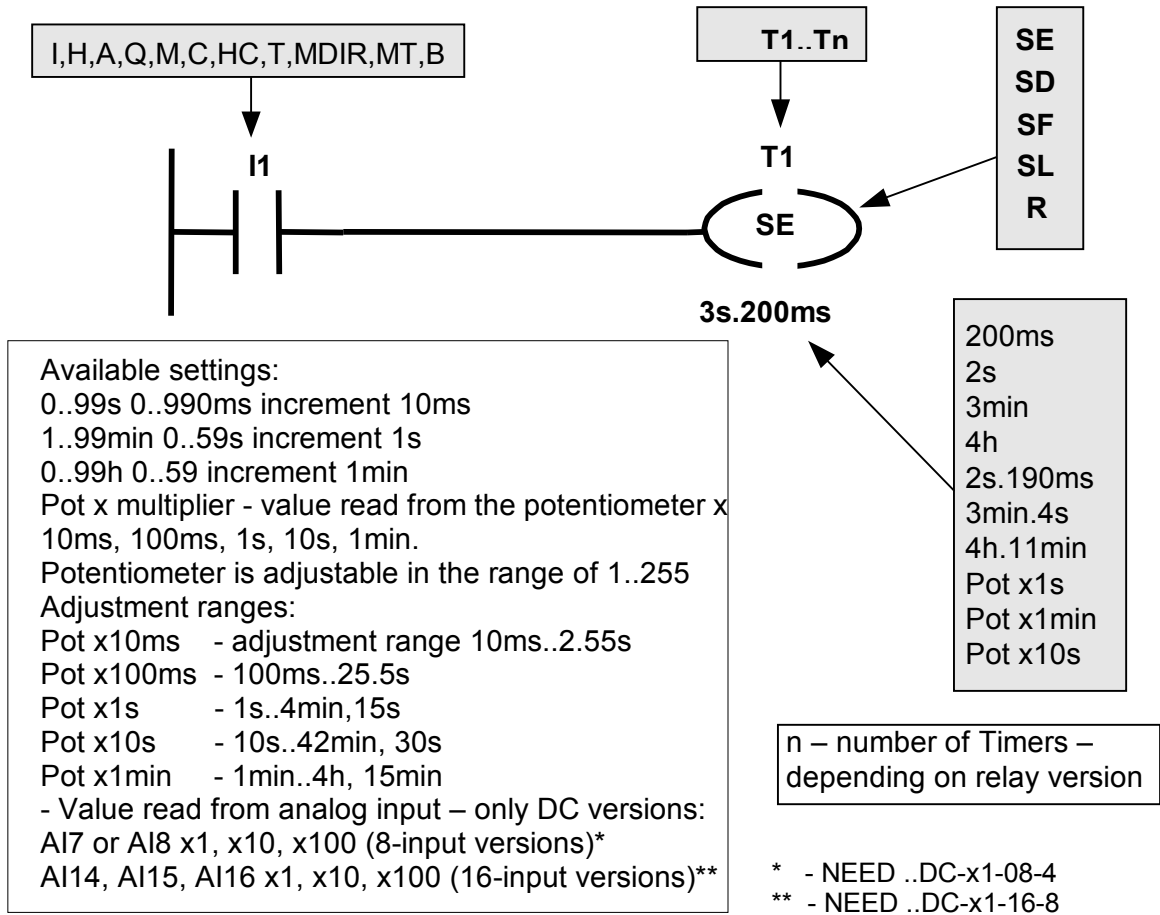

Fig. 5.2.7.4. Configuration of Timers.



For measuring time for *Timers*, it is possible to use the values of voltages read from the I7, I8 analog inputs in the NEED-12DC-xx-08-4, NEED-24DC-xx-08-4 version or I14, I15, I16 in the NEED-12DC-xx-16-8, NEED-24DC-xx-16-8 version. It is described in more details in Section 5.1.2.21.1. 'L' statement for Timers.

5.2.7.5. Configuration of Counters

Counters are presented using the same graphic symbol which are used for outputs – see Fig. 5.2.7.5. Expected Counter operation determines the symbol to be used inside the graphic designation of the Counter. The letter C, which stands for Counter, and Counter number are placed above the graphic symbol.

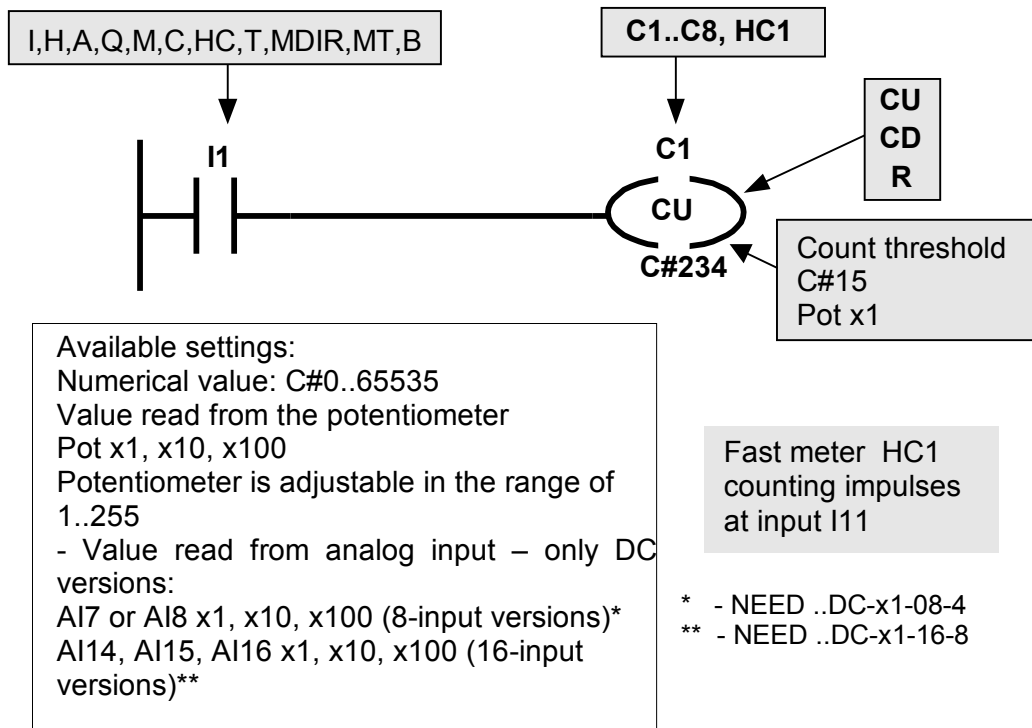

Fig. 5.2.7.5. Configuration of Counters.



The voltage values read from analog inputs I7, I8 for NEED-12DC-xx-08-4, NEED-24DC-xx-08-4 or I14, I15, I16 for NEED-12DC-xx-16-8, NEED-24DC-xx-16-8, may be used for setting the *Meter* threshold. A more detailed description is provided in chapter 5.1.2.21.2 The 'L' instruction for Meters.



The DC NEED.-xx-16-8 versions are equipped with a HC1 *Counter* HC1 counting pulses with a frequency of up to 20kHz. HC1 is a hardware-based *Counter*, counting pulses appearing on the I11 input. The CU, CD inputs, in addition to the counting function, also provide the function for activating the *Quick counter*.

The *Quick Counter* can run in the frequency mode – it counts pulses appearing at the I11 input during 1second.

The *Quick counter* never overflows. The counting threshold can be set in the range of 0..65535. Performing a Reset operation of a *Quick counter* rests the status and number of counted pulses.



In the frequency mode, the HC Quick Counter counts network frequency (50Hz or 60Hz) for the NEED-230VAC-x1-16-8 and NEED-230VAC-22-.. versions. Meanwhile, in the counter mode, it counts supply network impulses every 20ms (supply network frequency of 50Hz) or 16.6ms (supply network frequency of 60Hz). Fast meter may be used as an additional timer because the network frequency is known and constant. If threshold = 1000, then in the case of 50Hz the meter will switch after 100 x 20ms = 20s.

5.2.7.6. Sample configurations

Example 1:

SL Timer – Pulses (Pulse generator)

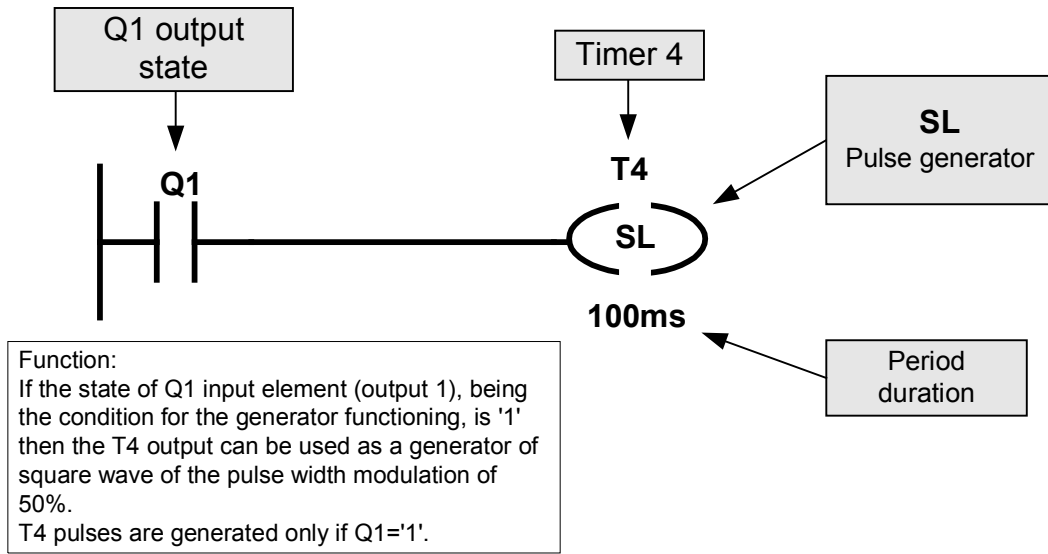

Fig. 5.2.7.6.1. Sample configuration of SL Timer.

Example 2:

Timer reset

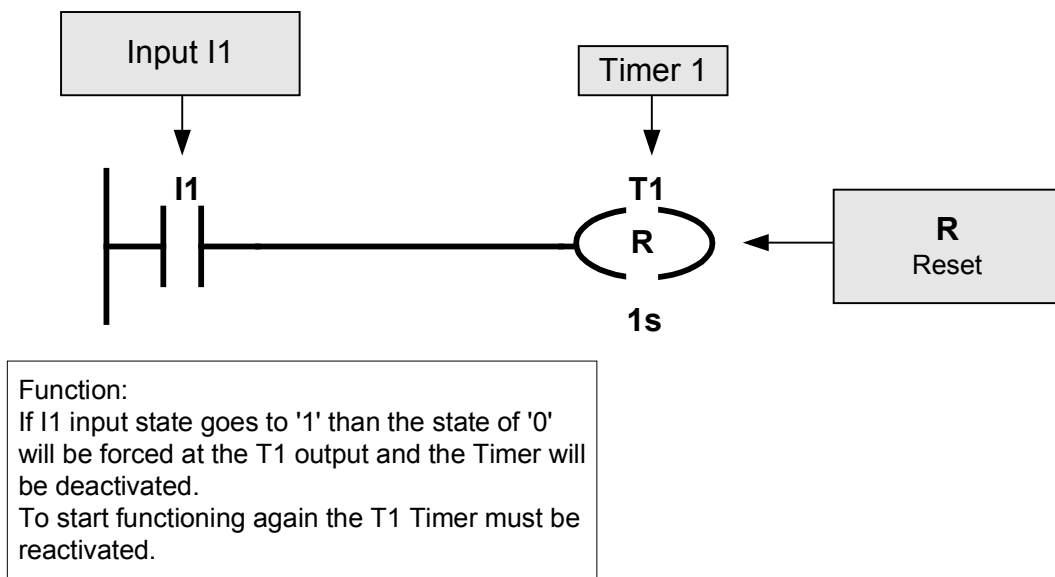

Fig. 5.2.7.6.2. Sample Timer reset.

5.2.8. Element location rules .

Fig. 5.2.8.1. illustrates a very simple program network including the arrangement of elements according to the structure described above. To make the illustration clearer the examples indicate discrete inputs and outputs.

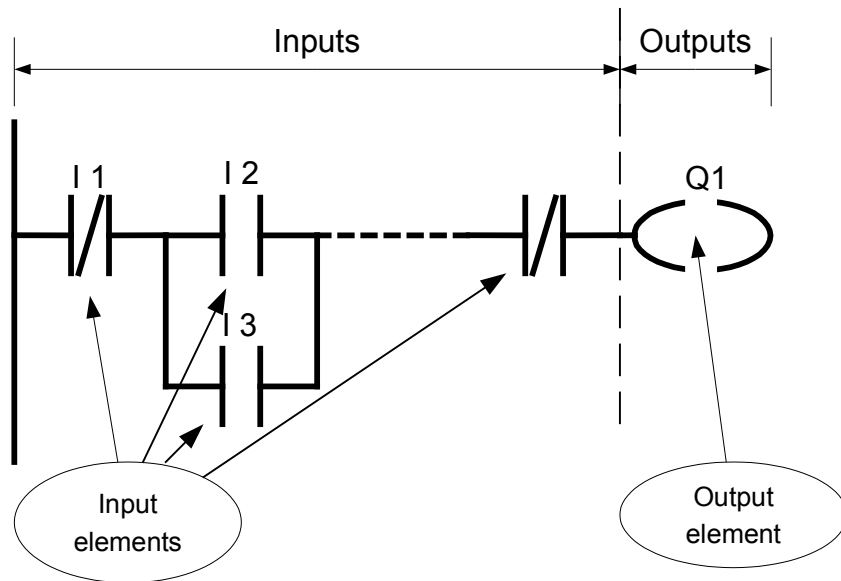

Fig. 5.2.8.1 LAD network

Generally the network is composed of the input part (conditional, preceding part) and the output part (executive, succeeding part). The first part determines the conditions that must be satisfied in order for the output to be activated (executive element).

Input elements can be interconnected in various ways, the number of such connections being dependent only on the legibility of the program and editing possibilities.



Note: The number of lines in the NEED relay is limited by program memory size, which depends on the relay version (e.g. once compiled, version 4 has a maximum of 862 bytes, while version 8 – 2,991 bytes).

5.2.9. Connection types.

Control system design requires a program which combines the relations between input and output signals in a suitable manner.

Basic connection types are presented below.

5.2.9.1. Mapping the input to the output.

I1 input state will be „copied” to the Q1 output. The Q1 output will be active (Q1='1') if the logical state of the I1 input is '1'.

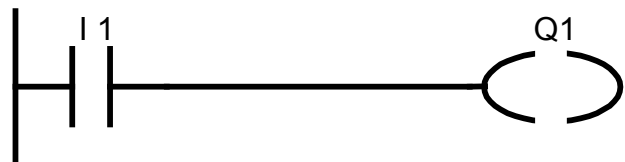

5.2.9.2. Mapping the negated input to the output.

Negated I1 input state will be copied to the Q1 output. The Q1 output will be active (Q1='1') if the logical state of the I1 input is '0'.

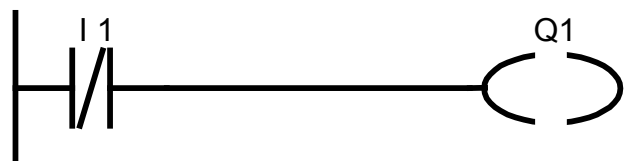

5.2.9.3. Series connection.

The above circuit performs the function of a logical product (AND operation). The Q2 output will be active (Q2='1') if both inputs (I1 and I2) are in the logical state '1'.

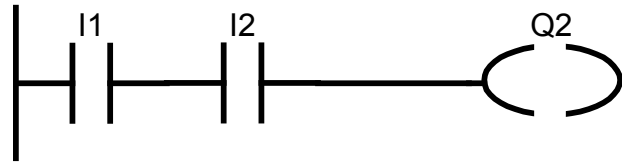

Other types of series connections are presented below

The Q2 output will be active (Q2='1') if the I1 input state is '1' and the I2 input state is '0'.

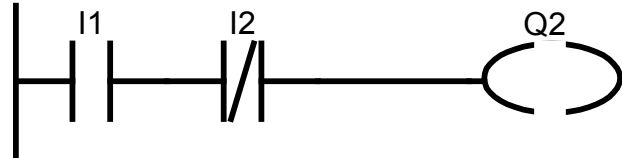

Series connection of 3 elements.
The Q2 output will be active (Q2='1') if logical states of all inputs (I1..I3) are '1'.

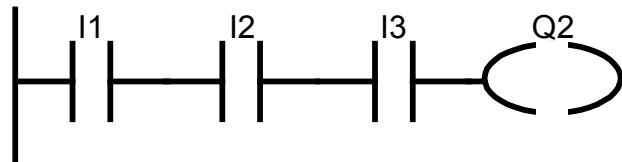

Series connection of 3 elements.
The Q2 output will be active (Q2='1') if the I1 input state is '1' and the states of I2 and I3 inputs are '0'.

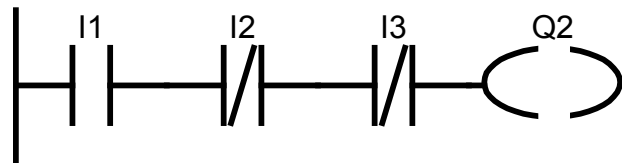

5.2.9.4. Parallel connections

The circuit presented beside performs the function of a logical sum. The Q3 output will be active (Q3='1') if one of the inputs (I1 and I2) or both of them are in the logical state '1'.

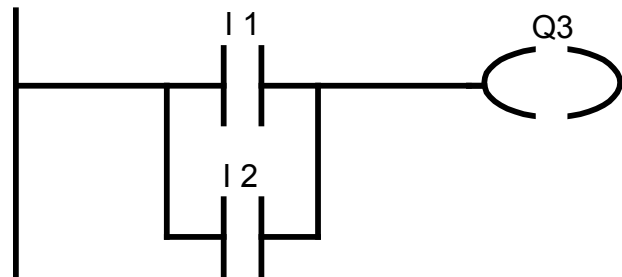

Other types of parallel connections are presented below

The Q3 output will be active (Q3='1') if one of the inputs (I1 or I2) or both of them are in the logical state '0'

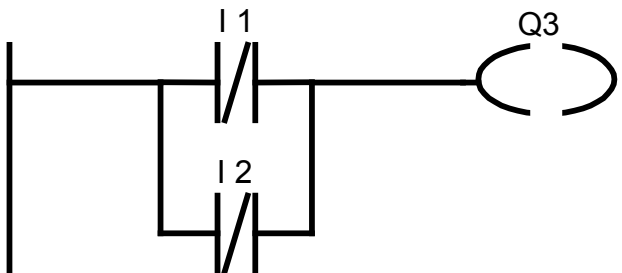

The circuit presented beside performs the function of a logical sum of 3 elements. The Q3 output will be active (Q3='1') if at least one of the inputs (I1, I2 or I3) is in the logical state '1'

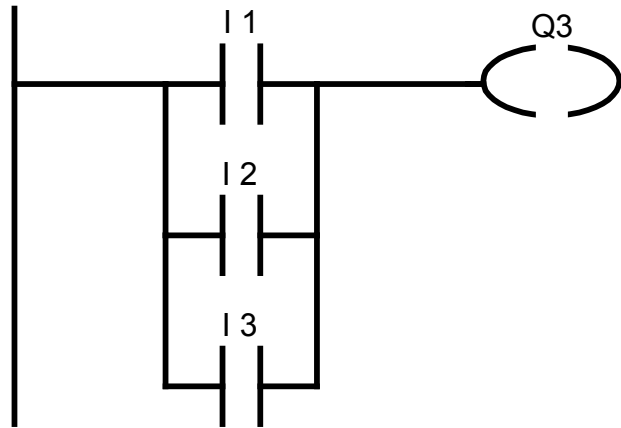

Logical sum of 3 elements. The Q3 output will be active (Q3='1') if the I1 input is active (state '1') or one of the inputs (I2 or I3) or both of them are in the logical state '0'

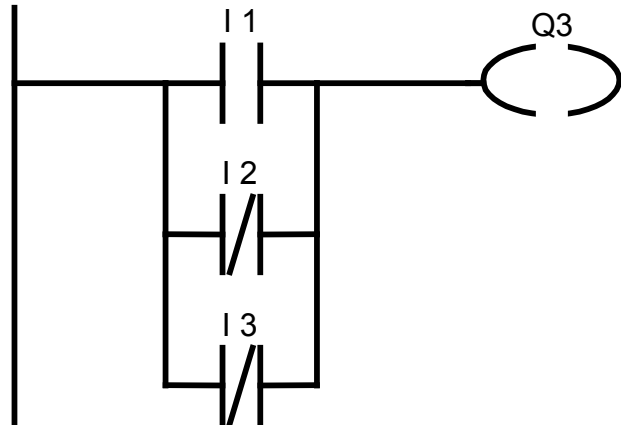

5.2.9.5. Series-parallel connection.

In order to present the control circuit, the basic connections described above can be combined as long as the permissible numbers of horizontal input elements (3) and vertical input elements (150) are not exceeded, according to connection rules.

If, in order to control the output, the algorithm requires a greater number of input elements to be used, then the connection ladder must be modified respectively, using Markers i.e. the tasks must be divided into smaller tasks.

Sample circuits employing combinations of series-parallel connections, including function interpretation, are presented below.

Circuit incorporating serial connection of I1 element with parallel-connected I2 and I3 elements.

The Q1 output functioning is as follows: Q1='1' if I1 is active (state '1') and the logical state of one of the I2 and I3 inputs (or both) is '1'.

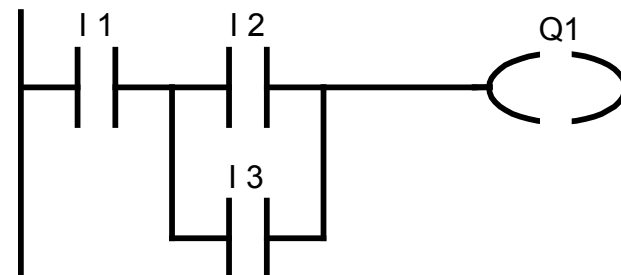

Circuit incorporating serial connection of I1 element with parallel-connected I2 and I3 elements and further series-connected I4.

The Q3 output functions as follows:
 Q3='1' if I1 and I4 are active (state '1') and one of the I2 and I3 inputs (or both) is inactive (state '0').

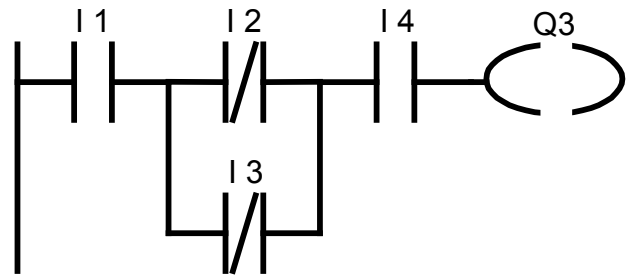

A circuit equivalent to that above can be presented in a different form: serial connection of I1, I4 comes first and is followed by a series connection of I2 and I3.

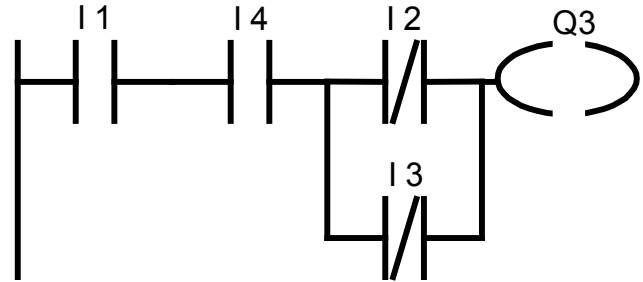

5.2.10. Symbolic names

For the NEED relays it is possible assign symbolic names to variables. This way the program is easier to analyze and clearer.

It is possible to toggle the variable/symbolic name view. Fig. 5.2.10. shows the circuit in ordinary notation and below with symbolic names.

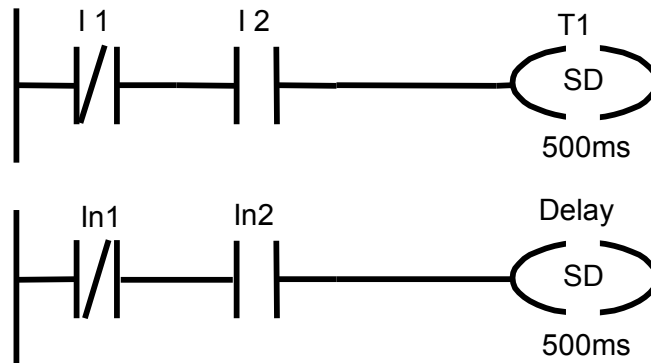

Fig. 5.2.10. Example of symbol use in LAD.

5.2.11. LAD program.

The program is composed of networks. The simplest program can include only one network (program line). A program composed of 3 networks is presented below.

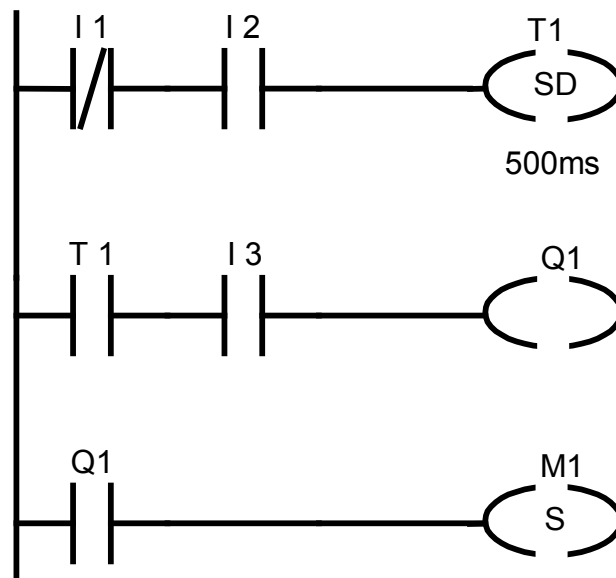

Fig. 5.2.11. Sample LAD program.

Program description:

The first network, as per Fig. 5.2.11., employs inputs which are connected directly to the programmable relay. The first input (I1) is of NC type, the second (I2) of NO type which means that the Timer is turned on if I1 = '0' and I2 = '1'.

States of T1 Timer (which is set in the network 1) and I3 input are checked in the second network (T1, I3, Q1). If the Timer is turned on (after 500ms counted from the time point when the condition of I1='0' and I2='1' has been met) and the I3 input is active (I3 = '1') then the Q1 output will be at high state (powered). Once the I3 input is turned off (I3='0') the Q1 output will be deactivated.

Network No. 3 is used to „remember” the turn-on of the Q1 input. Once the Q1 input state goes to '1' then the M1 Marker is permanently set (M1 = '1').

It should be noted that the program actually ends with setting the M1 Marker, as further M1 Marker operations (e.g. resetting) are not performed.

6. INSTALLATION AND SOFTWARE DESCRIPTION

PC Need is a computer program which can be used to edit, compile and load programs to the memory of the programmable relay. It additionally makes it possible to monitor the relay resources during operation which keeps the user informed on the states of inputs and outputs, Timers, Counters etc. This ensures full control over the program being currently executed.

Simplicity and diversity of the program edition (text or graphics) features make PC Need a very convenient tool enabling very fast creation of even most complicated applications with shorter implementation times.

6.1. Hardware requirements

Any PC with RS232 or USB interface. Operating system: Windows NT[®], Windows 98[®], Windows 2000[®], Windows XP[®], Vista[®].

6.2. Software installation

1. Place the installation CD in the CD-ROM of your computer.
2. If the installation is not started automatically find the "setup.exe" file on the CD and double-click it to start the installation.
3. During setup select an appropriate folder to install PC Need application to. If an option to put the icon on the desktop was selected then, after successful installation PC Need, an icon should be placed on your desktop. PC Need can also be launched using an icon on the taskbar.

6.3. Uninstalling

In order to remove the program from your computer it should be uninstalled automatically using **Start > Programs > Relpol > Uninstall PC Need**.

Selection of that option will result in the program being uninstalled.

6.4. Connecting the PC to the programmable relay

The programmable should be connected to the PC using a dedicated cable.

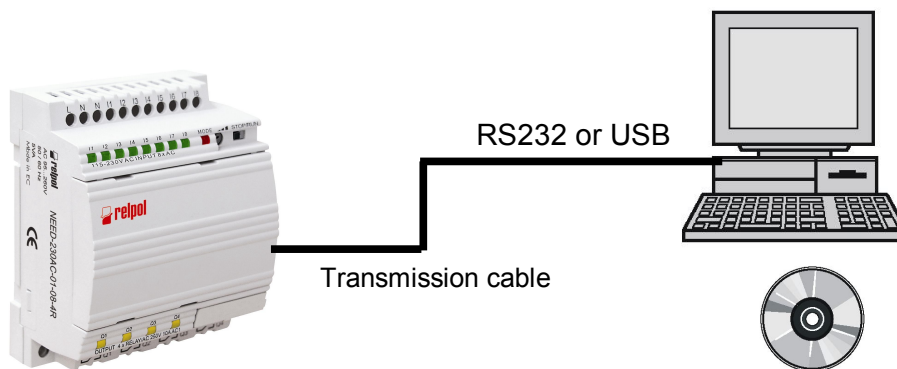

Fig. 6.4. Connecting NEED programmable relay with the PC



Should the power supply conductors i.e. the phase (L) and neutral (N) conductors, be interchanged when connecting to the power supply terminals of the programmable relay, dangerous voltages can be present at the communication terminal of the relay.

6.5. Quick start – creating the application

In order to create a specific control application based on the programmable relay an appropriate program must be written first. There are two editors available in PC Need:

- text editor to edit STL programs,
- graphics editor to edit LAD programs

Depending on the editor used the programs are written as files with `*.stn` extension (STL text editor) or `*.ldn` extension (LAD graphics editor).

Setup file `*.set` is used to edit the NEED relay resources (adjustment of Clock ON times, adjustment of comparison relations for the Comparators, values to be counted and operating modes for the Counters, time to be measured and operating modes for the Timers, remanent values).

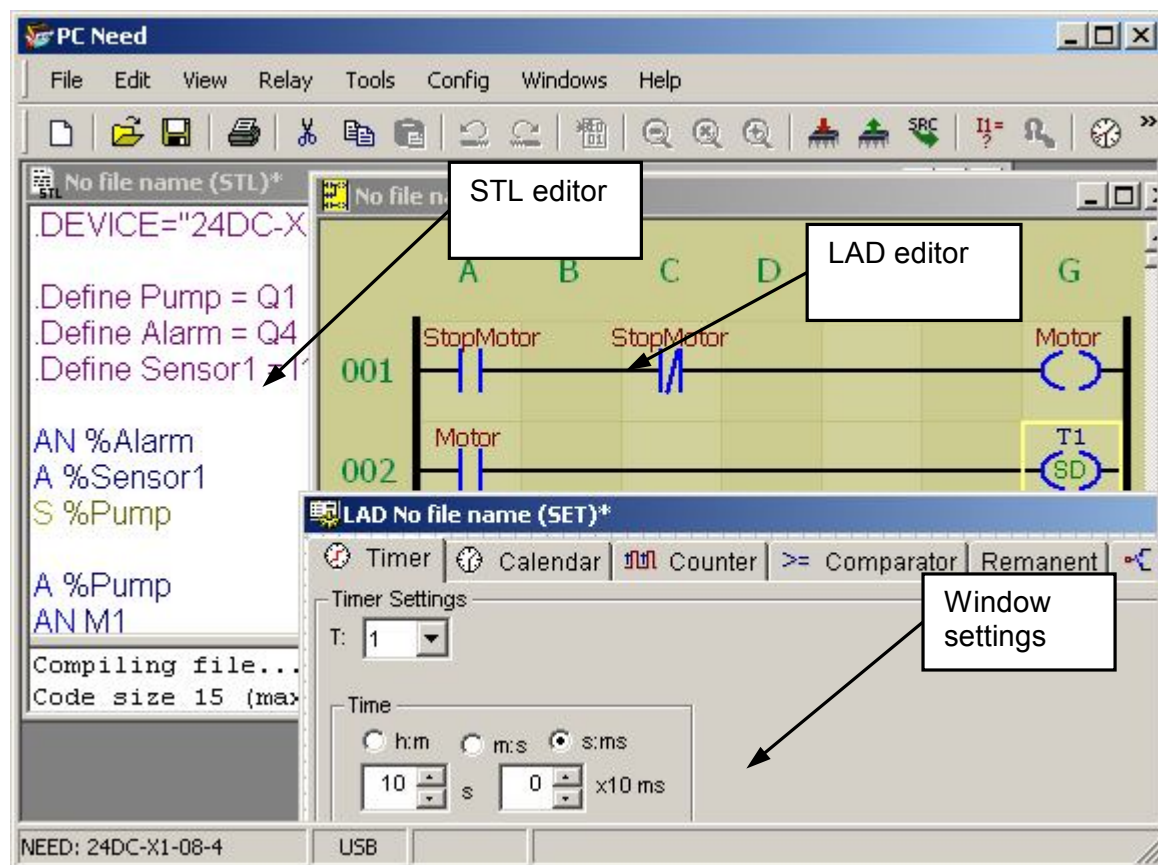

Fig. 6.5.1. PC Need program windows.

Any project for the NEED relay should contain at least one file with `*.stn` or `*.ldn` extension (user's program). If the programmer uses such programmable relay resources as Clocks or Comparators then the relay settings editable in the setting window (Fig. 6.5.1) must be loaded to the NEED relay memory, in addition to the source code (STL or LAD program).

In case of LAD editor an option **"Save settings with LAD data"** (active by default – see Fig. 6.5.2) can be set within the option of **Configuration > LAD project**. Once the option is checked a program file `*.ldn` and a setting window are loaded to the relay memory.



Fig. 6.5.2. LAD project configuration windows.

Fig. 6.5.3 illustrates schematically the project contents for the NEED programmable relay.

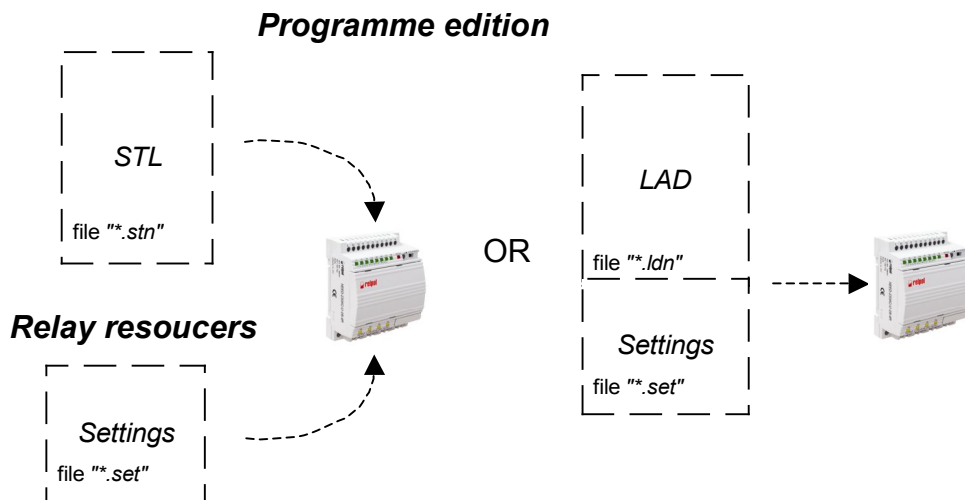

Fig. 6.5.3 Files included in the project for the NEED programmable relay

If the programmer uses Clocks, Comparators, remanence then the settings must be loaded to the relay memory.

Example:

Project: STL program without use of relay resources such as Clocks, remanences, Comparators etc. – Fig. 6.5.4.

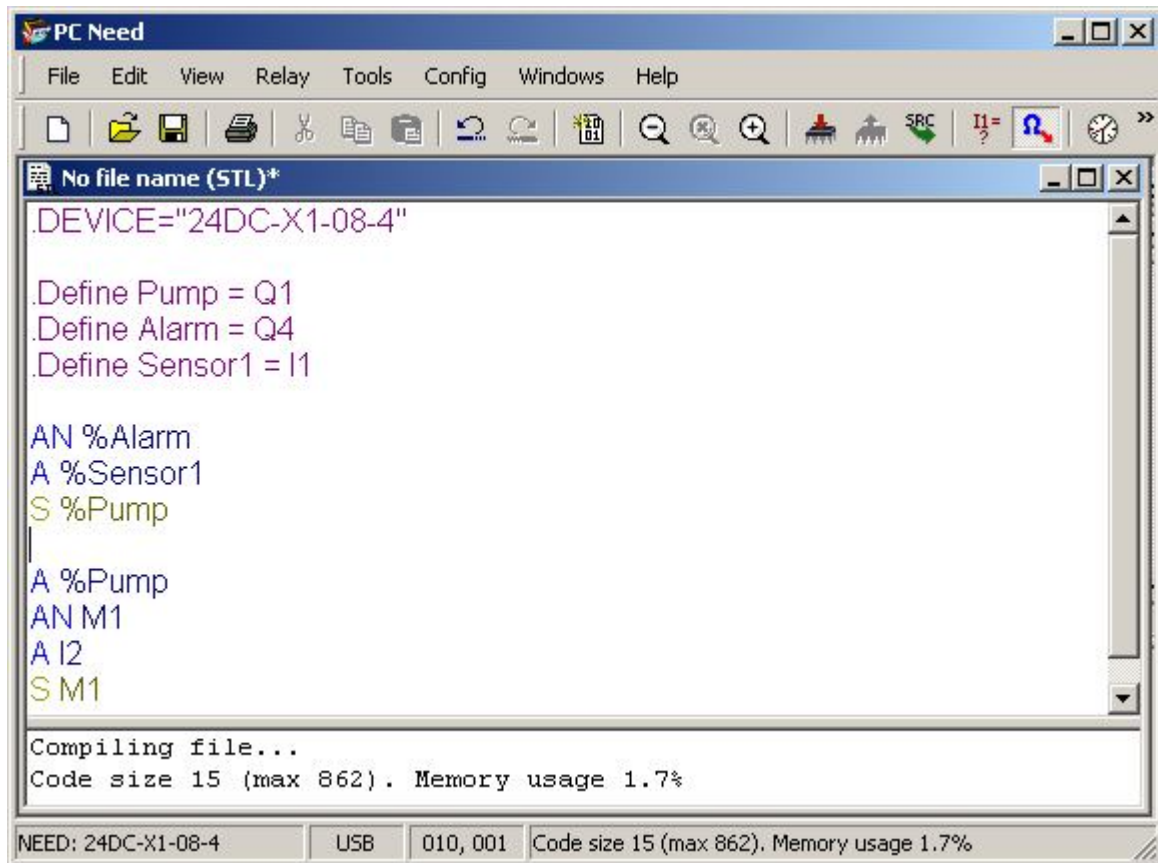

Fig. 6.5.4. STL program

Only `*.stn` file to be loaded.

Example:

Project: LAD program. Option checked: **“Save settings with LAD data”**.

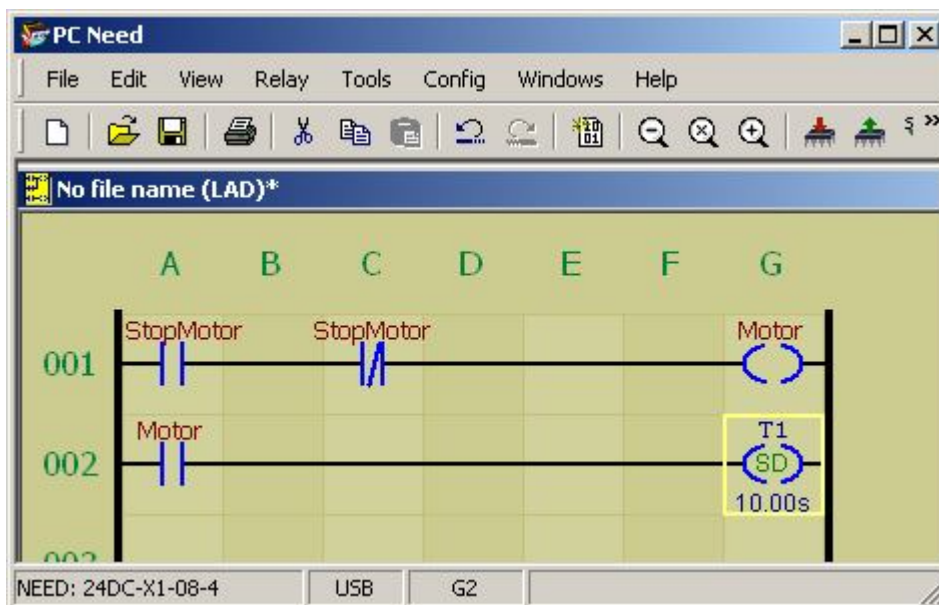

Fig. 6.5.5. LAD program

Upon selection of **“Relay > Transmission > Write to the relay”** from the Menu, a LAD program (`*.ldn` file) is saved in the programmable relay memory together with settings.

Example:
Project: STL program using Clock and Comparator

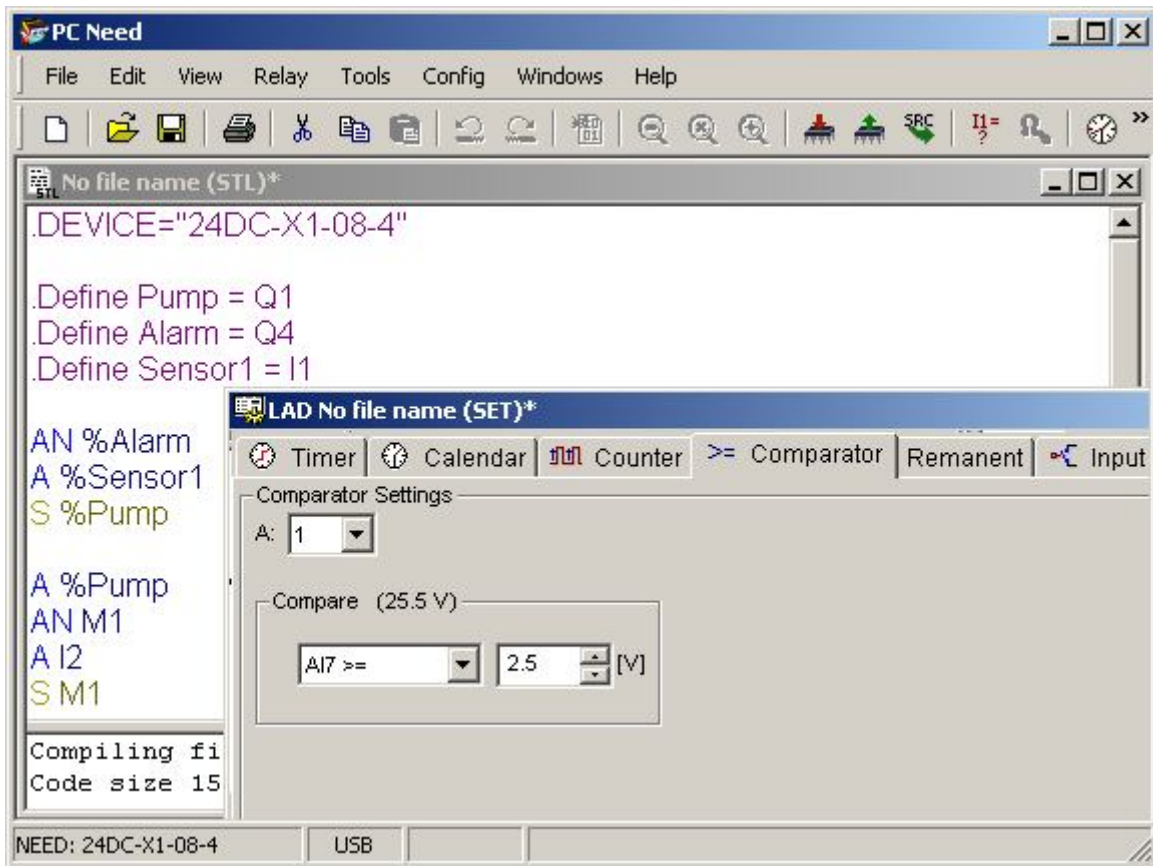
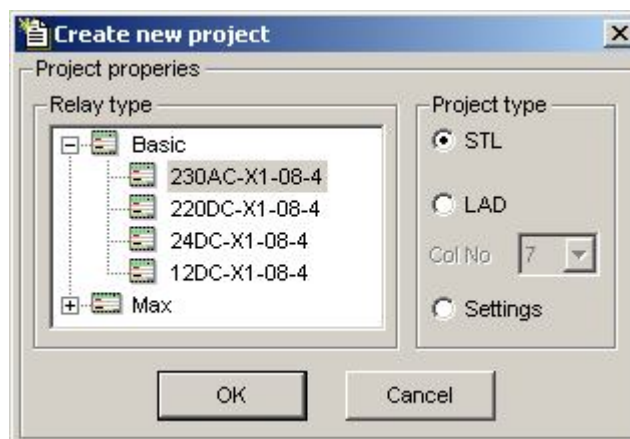

Fig. 6.5.6. STL program using Clock and Comparator

„Example2.stn” file and „Example2.set” settings to be loaded to the relay.

6.5.1 Sample project – STL program

1. Start PC Need.
2. Create new project e.g. **File > New** select the appropriate relay type in the selection window (see figure below) and select **STL** in the “Project type” field.



3. Write a program e.g. such as the one below

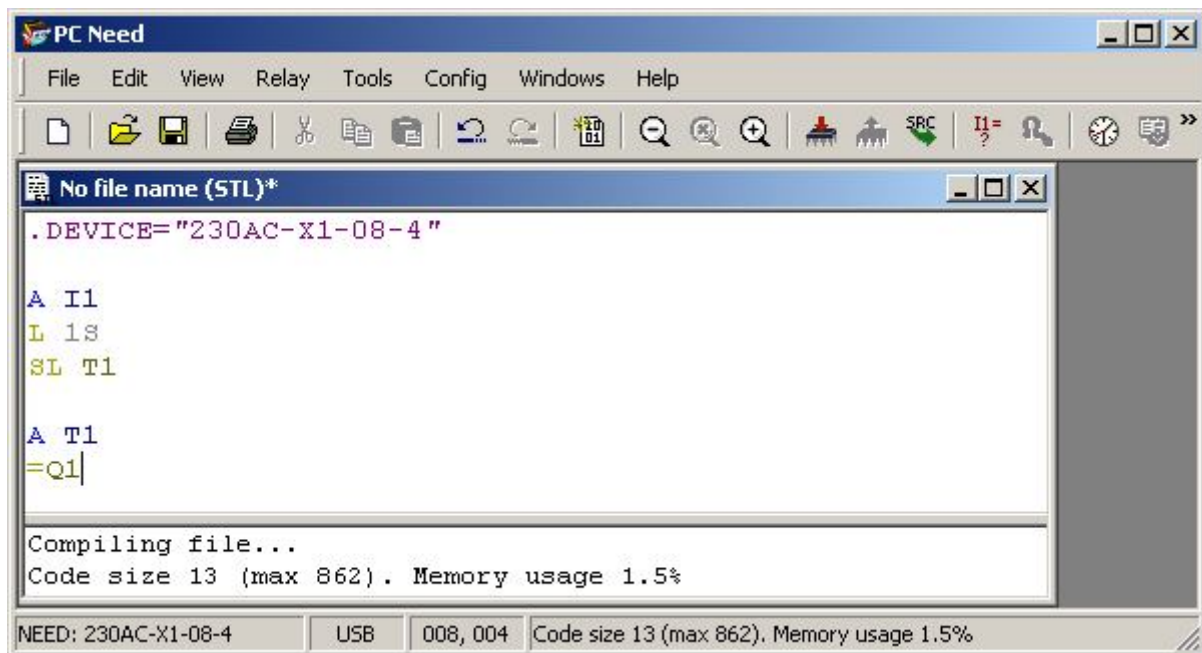

4. Connect the computer to the relay and carry out configuration of the USB port. **Config > Options > Port** – select the proper (free) port. The operation must be repeated only for the first start of the program or if the communication port is to be changed.

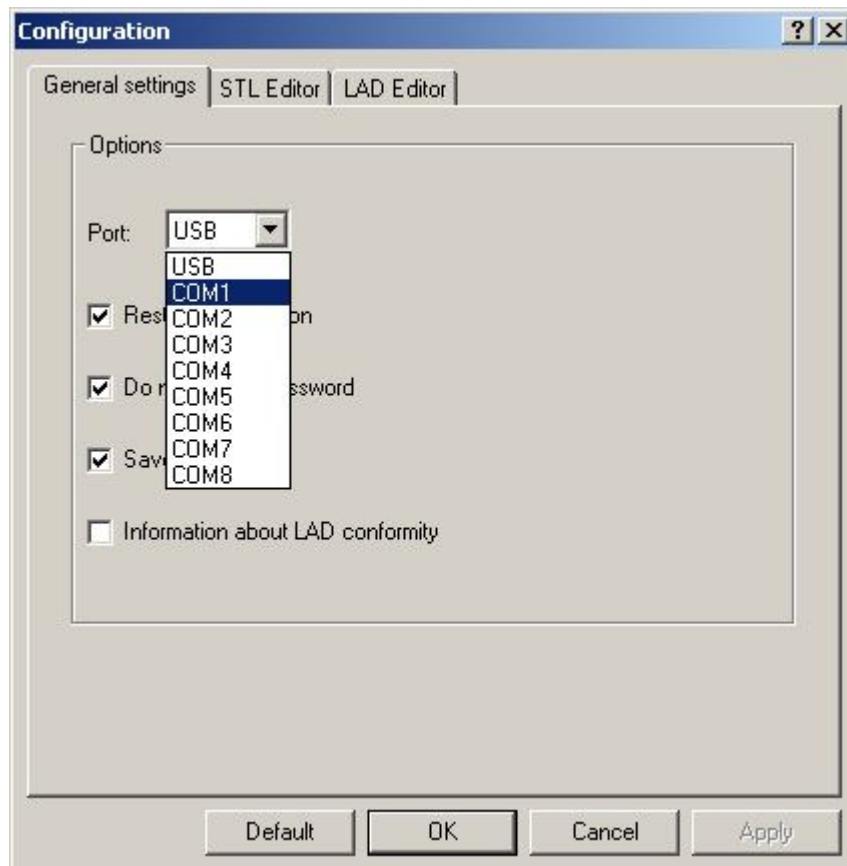

5. Set the relay to STOP mode (using switch or **Device > Stop**).

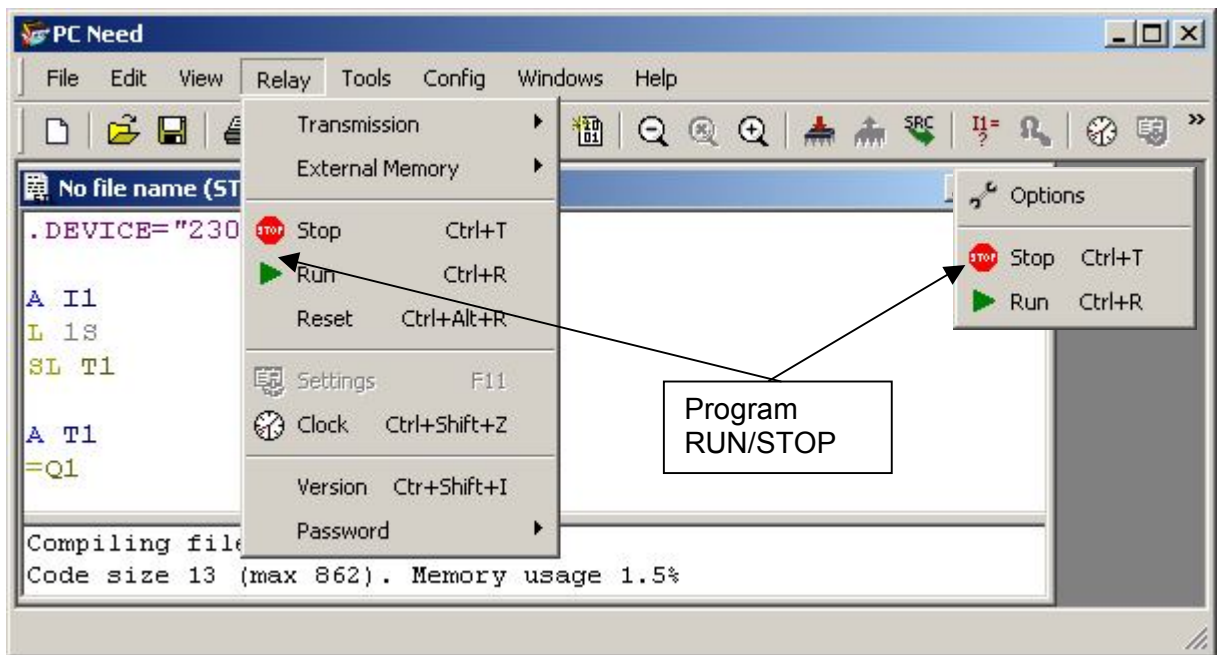

6. Load the program to the memory of the relay: **Relay > Transmission > Write to the relay**.

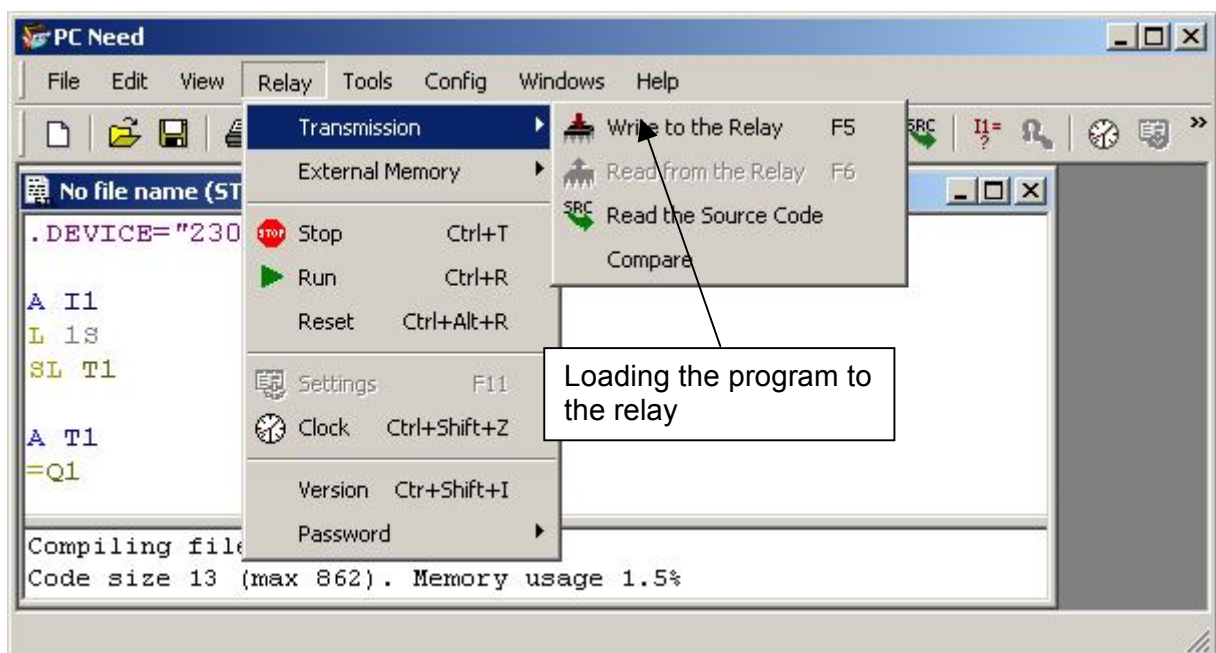

7. Switch the relay over to the **RUN** mode (using the switch or **Relay > Run**) and feed the signal (high state) to the I1 input. The Q1 output should flash (1-second on and 1-second off).

6.6. Working with PC Need

6.6.1. Main program window description

User interface window opens upon PC Need start.

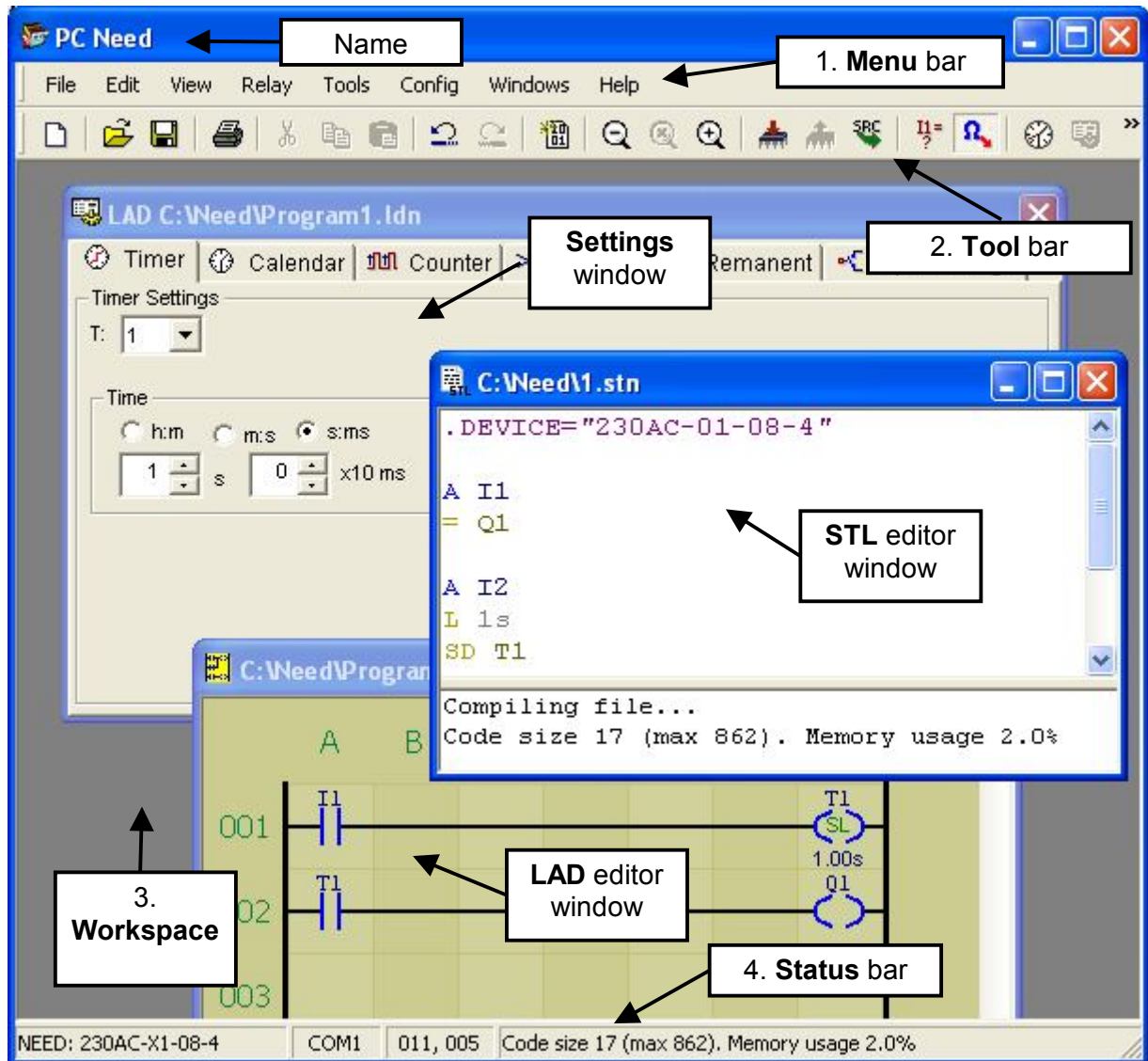
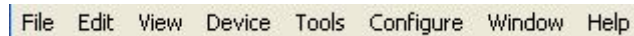

Fig. 6.6.1. PC Need user interface

User interface is composed of the following items:

1. Menu bar.



2. Tool bar.



3. Workspace – including windows i.a.: LAD, STL Editor, Settings, Configuration, Element settings.

4. Status bar.

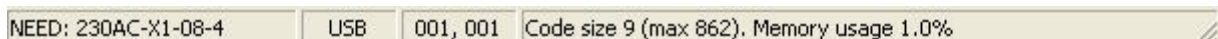

6.6.2. Menu bar

File – management of file operations

- > **New** – opening of the project selection window: STL, LAD, Settings
 - >> **STL** – creation of a new file in STL language editor
 - >> **LAD** – creation of a new project in LAD language editor
 - >> **Settings** – creation of a new file of SET settings
- > **Open** – opening of an existing file for edition or change of settings; files opened:
 - *.stn – files written in STL text language
 - *.ldn – files written in LAD ladder language
 - *.set – setting files (SET)
 - („*” – file name; .stn extension – file type
- > **Save** – saving the file to disc
- > **Save as** – saving the file to disc by creating a new file
- > **Document** – information on the software being created (to print table)
- > **Convert Document** – opening the window - enable automatic transfer of program code and settings between different relay types
- > **Page setup**
- > **Print preview**
- > **Print** – printing the document
- > **Recent projects** – shortcuts to the most recent projects
- > **Exit** – Alt+F4 ending the work with NEED

Edit – program edition commands

- > **Undo** - undoes the last operation
- > **Redo** - redoes the undone operation
- > **Cut** - cutting the selected content
- > **Copy** - copying the selected content
- > **Paste** - inserting the content in the selected place
- > **Delete** - deleting the selected content
- > **Search** - search window (STL, LAD)
- > **Find next** - searching for the next same element (STL, LAD)
- > **Replace** - possibility to replace the element with a different one

View – setting the NEED program window parameters – active if edited (open) in the LAD ladder language

- > **Zoom** - matching the area in the LAD editor window
 - >> **Zoom in** – increasing the size
 - >> **Zoom out** – decreasing the size
 - >> **Normal** – default size
- > **STL window** – displays STL window with resultant compilation code of LAD language.

Relay – set of relay operation features

- > **Transmission** – support of the relay communication
 - >> **Write to the relay** – program compilation and sending the program executive code to the relay or saving of the new settings (depending on the window currently active)
 - >> **Read from the relay** – reading the settings from the relay or reading the values for previewing of the variables (depending on the window currently active)
 - >> **Read the source code** – reading source code from the relay (only the NEED ...-16-8 version relays)
 - >> **Compare** – comparing the code of the program currently saved on the disc with the program saved in the relay (comparison to the

active open code in the editor)

- > **External memory** – memory module support
 - >> **Write** – writing the current program or settings to the memory module. Currently open program or setting file is saved. If you want to load both the program and the settings the saving must be performed twice, once for the active program window and once for the active settings file window
 - >> **Read** – reading the settings from the memory module
 - >> **Status** – information on the memory partition status and disabling of the partition
- > **Stop** – command to switch the relay into STOP mode
- > **Run** – command to switch the relay into RUN mode
- > **Reset** – resetting the program memory, settings in the relay and the password
- > **Settings** – opening the setting edition window
- > **Clock** – opening the window of relay time management
- > **Version** – information on type and the relay software version
- > **Password** – protection against reading and saving the program in the programmable relay
 - >> **Enter** – inputting password to be verified against the password in the relay
 - >> **Change** – change of the existing password including verification

Tools – set of functions to start the application

- > **Compile** – program compilation
- > **Object configuration** – opening the window with contact parameters (LED editor)
- > **Variables preview** – opening the window to preview current values of variables in the relay. Enabling the preview **Relay > Run**. It must be entered in the table which variables are subject to reading.
- > **Symbolic IDs** – changing variable display method – registers/symbol names

Config – PC Need options

- > **Options** - Access to programme options (including selection of communication port, options of editors)
 - General – selection of communication port, decision to open files from the previous session; cancelling the password protection
 - STL editor – default or own editor settings
 - LAD editor – default or own editor settings
- > **LAD project** – window opening – options of saving the program code and settings and the decision to open STL window after compilation of LAD program
- > **Language** – changing language versions

Windows – managing the open windows in the workspace of the NEED program























- > **Cascade** – stacking the windows
- > **Tile** – arranging the windows side by side
- > **Windows info**

Help – help file and information on the program

- > **Index** – Html help
- > **About PC Need** – information

6.6.3. Toolbar

The most frequently used menu options are toolbar buttons which, once clicked, enable quicker opening of individual program functions. Below please find a brief description of toolbar buttons.

	New	Create a new document (file)
	Open	Opens an existing document (file)
	Save	Saves active document
	Print	Prints active document.
	Cut	Cuts the selection
	Copy	Copies the selection
	Paste	Pastes the selection
	Undo	Undoes the last operation
	Redo	Redoes the undone operation
	Compilation	Active document compilation
	Zoom out	Reduces the window contents size (LAD, Variable view)
	Normal view	Sets the default view (LAD only)
	Zoom in	Enlarges the window contents size (LAD, Variable view)
	Save	Saving (transmission) to the relay (LAD, STL, SET)
	Read	Reading (transmission) from the relay (LAD, L, SET, ladder view, variable view)
	Read source	Reading the source program from the relay
	Variable view	Reading the status of selected variable from the relay
	Symbolic names	Toggling the address/symbol view
	Clock	Opens real-time clock window (RTC)
	Settings	Opens settings window
	Options	Access to programme options (including selection of communication port, options of editors)
	Stop	Sets STOP mode in the relay (Program stop)
	Run	Sets RUN mode in the relay (Program start)

6.6.4. Keyboard shortcuts

PC Need provides access to most commands through keyboard shortcuts.

The following are functions assigned to keys or key combinations.

PC Need

F1	Display the online help.
F3	Find the next occurrence of a word (in STL) or an item in LAD. The Find window must be displayed first.
F5	Save data to the relay (STL or LAD and or SET)
F6	Read data from the relay (SET)
F7	Compile
F11	Display the settings window (for the active LAD window)
F12	Display the variable view window
CTRL + "N"	New Project window
CTRL + "O"	Open File window
CTRL + "S"	Save the file in the active window
CTRL + "P"	Print the document
ALT + F4	Exit the NEED program
CTRL + "Z"	Undo
CTRL + "Y"	Redo
CTRL + "X"	Cut
CTRL + "X"	Cut
CTRL + "C"	Copy
CTRL + INSERT	Copy
CTRL + "V"	Paste
SHIFT + INSERT	Paste
CTRL + NUM+	Enlarge the window contents (normal zoom)
CTRL + NUM-	Reduce the window contents (reduce the zoom)
CTRL + NUM*	Default size of window contents (enlarge zoom)
CTRL + T	Set the STOP mode in the relay
CTRL + R	Set the RUN mode in the relay
CTRL + ALT + "R"	Relay reset
SHIFT + CTRL + "Z"	Open the relay time management window

CTRL + SHIFT + "I"	Information about relay software type and version
SHIFT + CTRL + "A"	Display the "item setting" window (for the active LAD window)
ALT + "/"	Display the About PCNeed window

LAD Editor

A	Insert a comparator
C	Insert a counter
D	Insert MDIR
H	Insert a clock
I	Insert an input
M	Insert a marker
Q	Insert an output
T	Insert a timer
SHIFT + "C"	Insert a quick counter (HC)
CTRL + "A"	Select the whole LAD diagram
SPACE BAR	Draw a horizontal line
ENTER	Show the Item settings window
Left ALT + ←	If an item is selected then the LEFT and RIGHT arrows change the NO/NC FP,SE, SD, SF,... functions If no item is currently selected, holding the left ALT and a direction arrow enables drawing horizontal lines of item connections.
Left ALT + →	
Left ALT + ↑	If an item is selected, then the UP and DOWN arrows change the register number function. If no item is currently selected, holding the left ALT and a direction arrow enables drawing vertical lines of item connections.
Left ALT + ↓	
HOME	Work the same as in text editors. Additionally, use them together with SHIFT for selecting.
END	
Page Up	
Page Down	

Explanation:

F2 – pressing the F2 function key

CTRL+S – Press the Ctrl key and the S key at the same time

CTRL+NUM+ – press the Ctrl key and the + key on the numeric keypad at the same time

CTRL+ALT+ "R" – pressing the Ctrl and (left) Alt and the R key at the same time

CTRL+SHIFT+ "Z" – pressing the Ctrl and SHIFT and the Z key at the same time.

6.7. STL program editor

Program edition in STL language is carried out in STL editor – see window below.

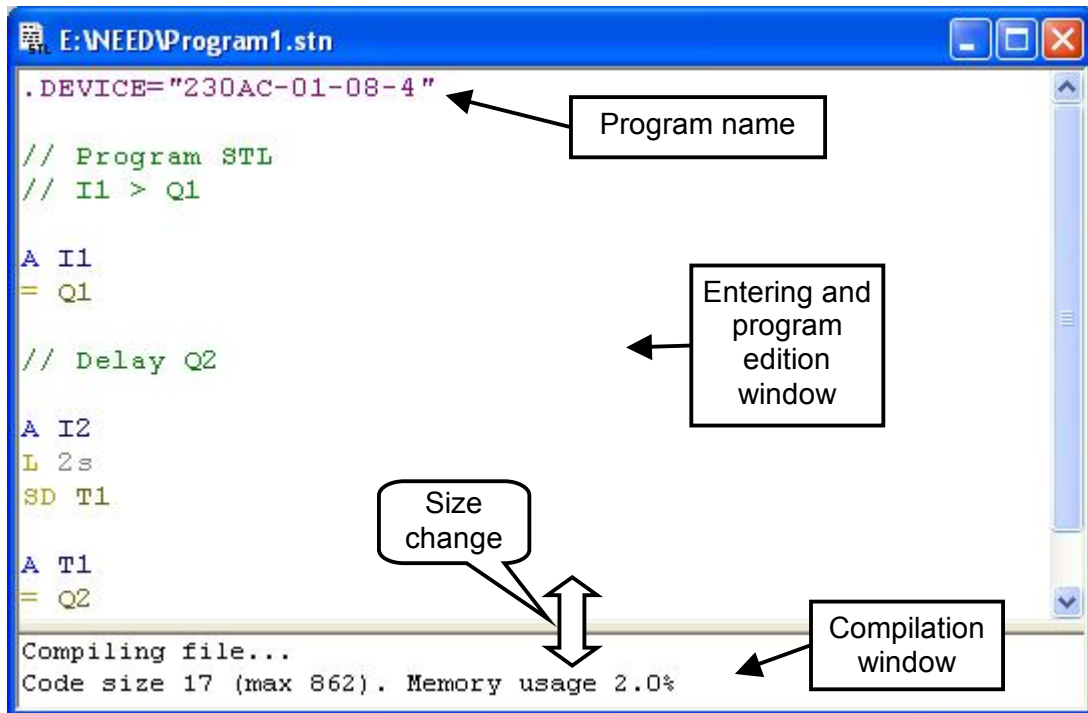

Fig. 6.7.1. STL editor.

6.7.1. STL editor

Editor window is opened in the workspace of PC Need and follows the Windows® standards as regards the change of size and location, and closing.

Editor operation is similar to the use of a simple notebook. Text is entered from the keyboard using syntax principles given in Item 5.1. Programming is made in STL text language. It is possible to delete, shift or copy a selection or the entire text.

- *Marking* – made using a mouse or a keyboard *Mark* –SHIFT+arrow keys (simultaneously press SHIFT and selected arrow keys, according to the shifting direction) – mark the selected text.
- *Cut* – mark the text to be cut and *Cut* it by simultaneously pressing Ctrl and X keys. The text cut will be stored in the clipboard.
- *Delete* – mark the text to be deleted and perform *Delete* operation – “Del” key.
- *Paste* – put the cursor where the beginning of the text to be pasted is to be located, perform “Paste” command – combination of “Ctrl” and “V” (simultaneous pressing of Ctrl and V keys). Upon completion of the operation the content of the system clipboard is inserted.
- *Transfer* – consists in marking (*Mark*) of the selected text and cutting it (*Cut* Ctrl+X) followed by pasting at the required location (Paste Ctrl+V).
- *Copy* – mark the text to be copied (see: *Mark*) and *Copy* it using the combination of Ctrl and C keys (simultaneous pressing of Ctrl and C keys).

Comments

In order to improve the legibility of the program being edited comments can be added to it. The text included in a comment is not parsed when creating the executable code.

A comment which starts with „// or” is valid to the end of the line. Such a comment can be started from the beginning of the line or from the point behind a written instruction.

Examples:

```
// This is a comment starting from the beginning of the line.
; This is also a comment starting from the beginning of the line.
A I1 ;This is a comment inserted behind an instruction.
```

In order to omit a greater number of lines during compilation the following comment can be used: `/* text */` Such a type of comment must define the beginning and the end of the text which will not be included in the program code.

Example:

```
/* A I1
A I2
= Q1
*/
A I3
=Q2
```

The first three instructions will be omitted when compiling the program. The source code will be created starting from A I3 instruction.

6.7.2. STL Compilation

Initially the bottom window is empty, and after running the compile command (F7) the compilation report is displayed. If the program is correct a message is displayed (see Fig. 6.7.1.) to provide information on completion of the program compilation, code size and percentage of relay memory occupied.

Should the program contain errors, the message will indicate the error type and location [row number, column number] – Fig. 6.7.2., including comment.

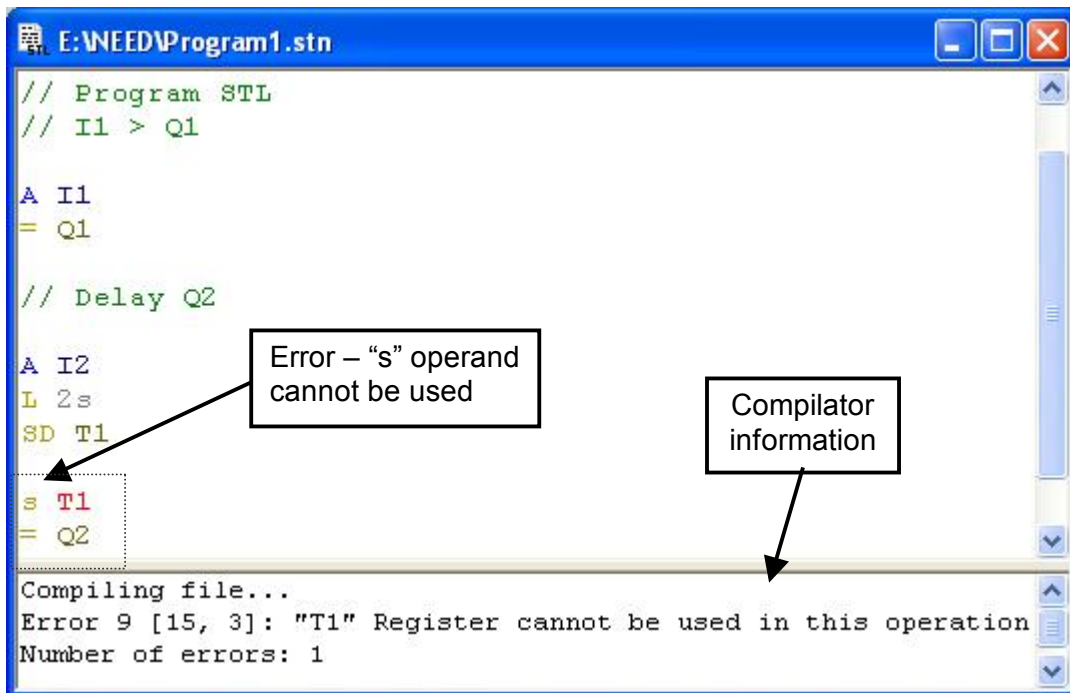

Fig. 6.7.2. Compilation error.

6.7.3. Configuration of STL editor

It is possible to adapt the appearance of the edition window to own preferences in

Configuration > Options STL editor tab. The following can be set:

- background colour
- colour of comment font
- colour of input element font
- colour of logical operator font
- colour of output element font
- colour of function font on outputs
- colour of argument font
- colour of directive font (.DEVICE, .DEFINE)
- colour of unrecognized text font
- font (type, style, size, script)

Default settings can be restored any time.

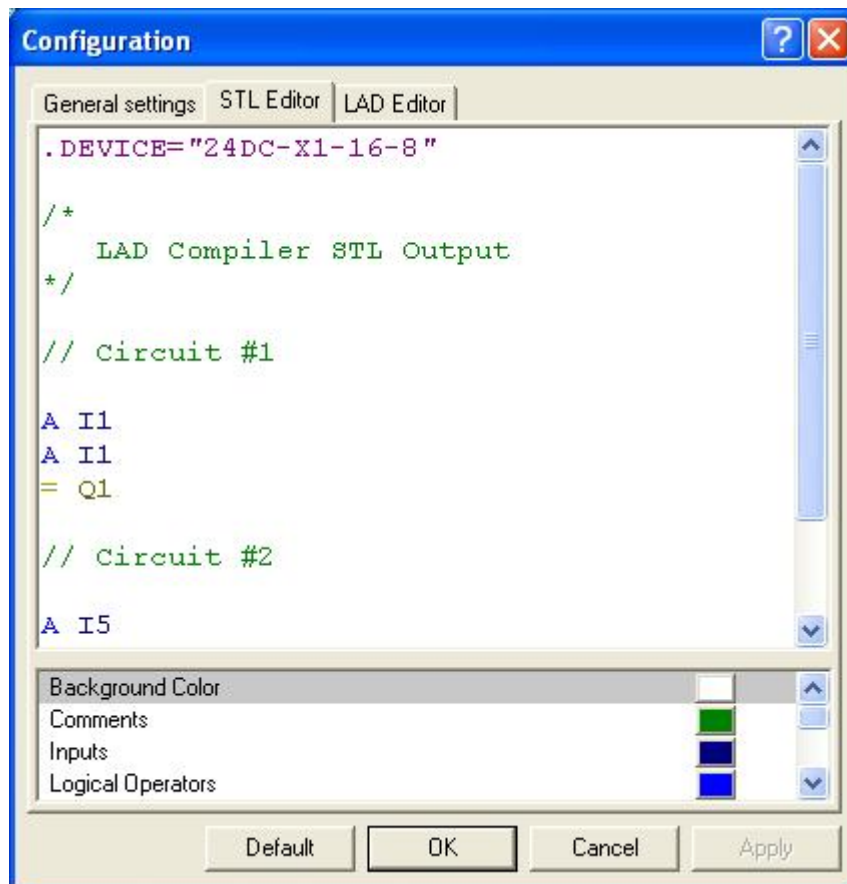

Fig. 6.7.3 Configuration of STL editor.

6.8. LAD program editor

6.8.1. New program

In order to create a program in LAD language, select **File > New > LAD** from the Menu after starting PC Need program.

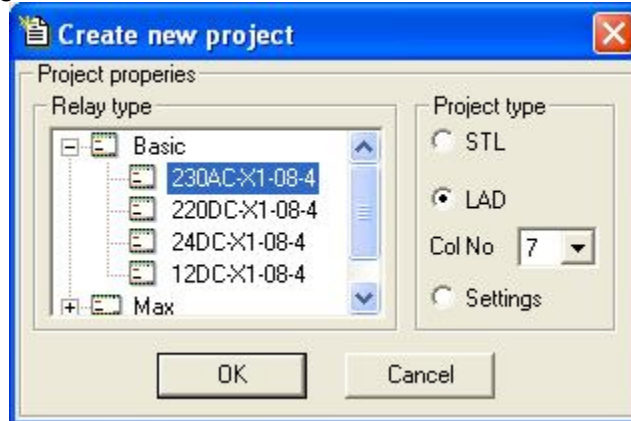

Fig. 6.8.1.1. New LAD project.

Select relay type, LAD project type and define number of LAD ladder columns. Selection is confirmed by pressing *Enter* or clicking the left mouse button.

LAD editor window will be opened in the workspace.

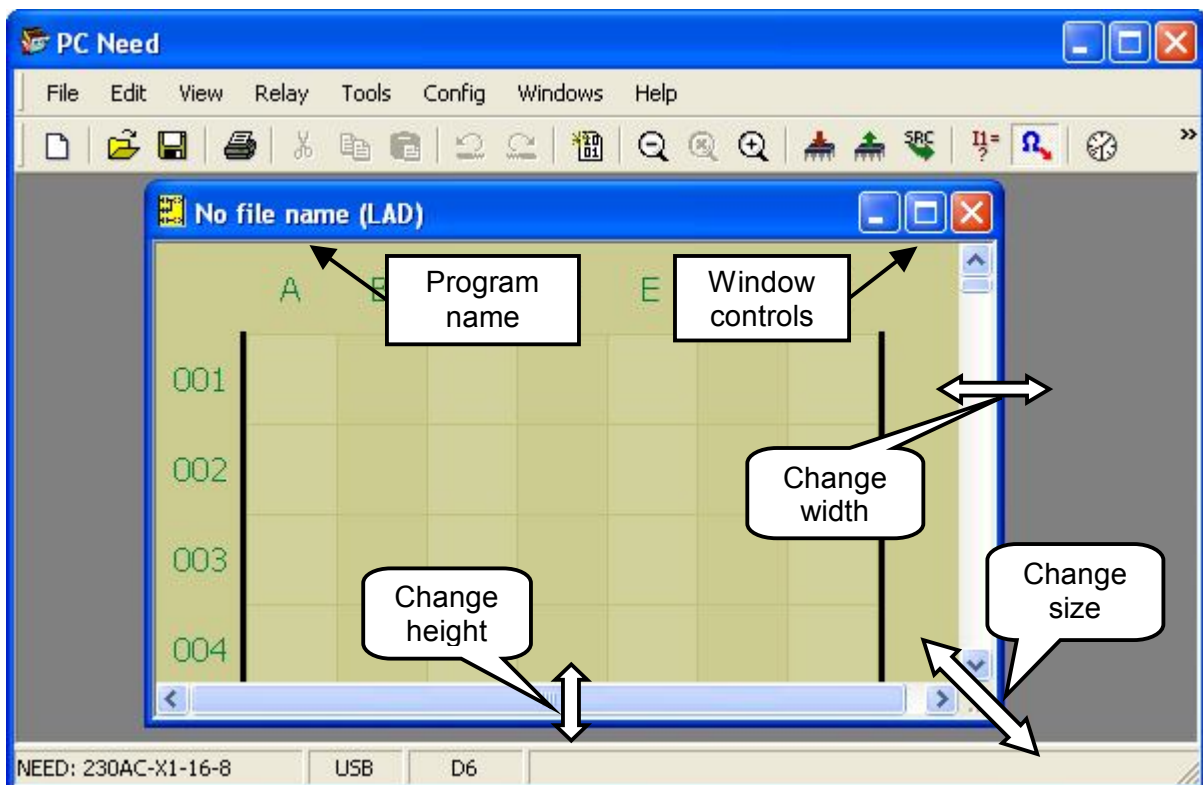



Fig. 6.8.1.2. LAD Editor – new program.

Window size can be adjusted according to the requirements and preferences using mouse. By using the standard window control buttons  the LAD editor window can be maximized, minimized or closed (x).

6.8.2. Saving a program

Since a newly opened program has no name (*No name (LAD)*) it must be saved under an appropriate name. To do so go to File menu and select Save As option.

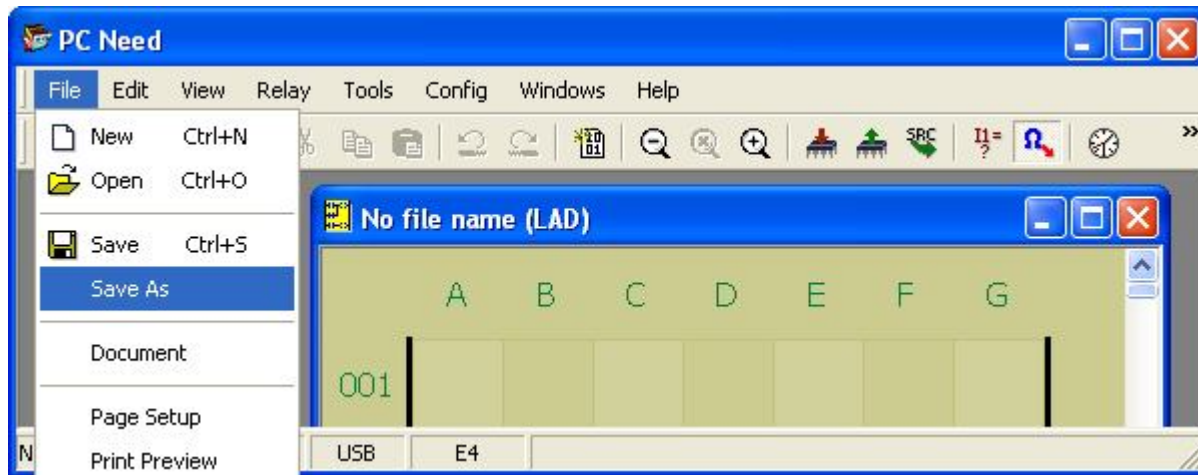

Fig. 6.8.2.1. „Save As” window.

Clicking the left mouse button opens the **Save file** window.

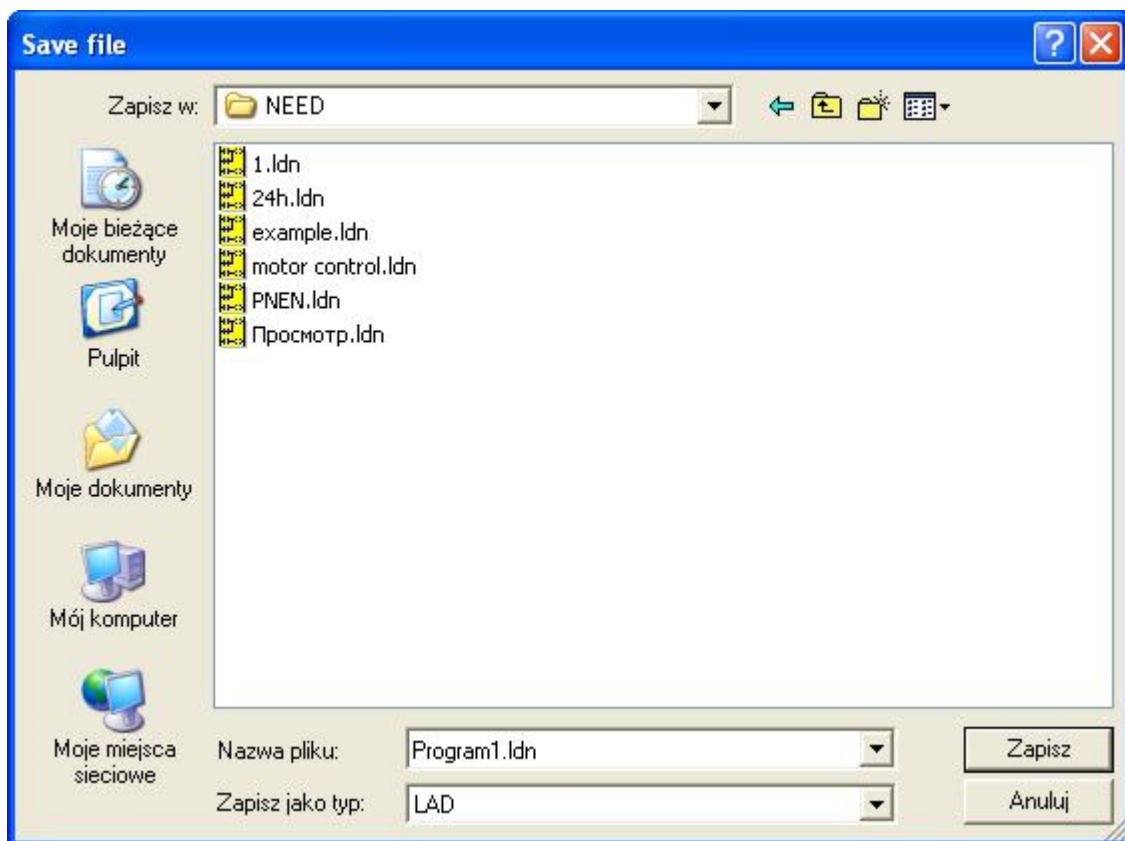

Fig. 6.8.2.2. LAD „Save file” window.

Select file location (access path), here:

Save in: NEED;

File name: enter e.g. Program1;

Save as type: LAD (default file name extension – .ldn)

and confirm the operating by clicking Save button.

6.8.3. Opening an existing program

In order to open an existing document go to **File** menu and select **Open**. A standard file manager window is opened (see above). Select the file with **.ldn* extension. A similar result can be achieved by clicking  in the toolbar or using a keyboard shortcut **Ctrl+O**.

6.8.4. Program edition

Create a new LAD program from **File** menu (see 6.8.1.) and name it e.g.. *Program1.ldn* (see 6.8.2). Adjust the window size to obtain a LAD editor window.

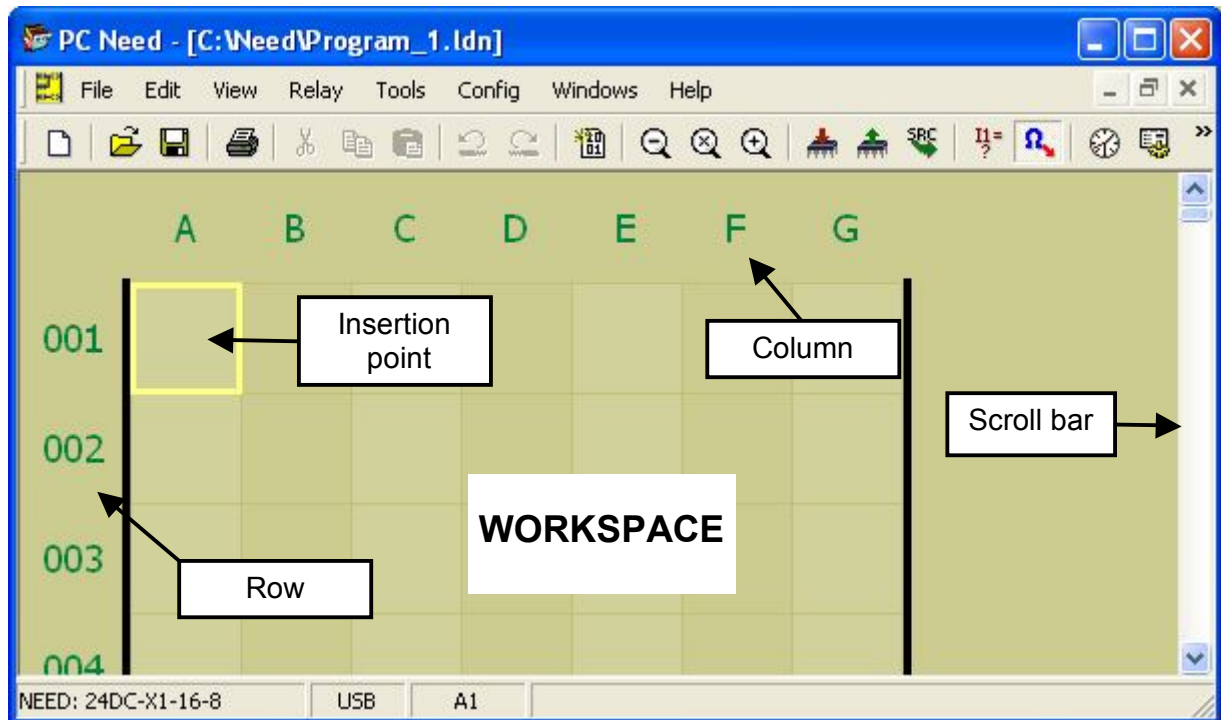

Fig. 6.8.4.1. LAD Editor window.

The work area is a grid based on squares, the location of which is defined by columns marked **A, C, E...** and rows numbered **001..150**.

The **A, C, E...** columns are used for inserting input components of the program (physical inputs, condition of outputs, *Markers, Timers, Counters, Clocks, Comparators*) or connections.

The **B, D, F...** columns are used for inserting connections between elements.

The last column is used for inserting output items (physical outputs, *Markers Timers, Counters*).

Drawing a connection diagram

Use the mouse to move the cursor over square grid cells inside the LAD editor window; the cell currently selected is marked with a grey border. Additionally, cell coordinates (row, column) are indicated in the left-hand bottom corner of the status bar. A cell is selected by placing the cursor over it and clicking the left mouse button. Once the cell is selected (marked) use the left mouse button to select object or connection (depending on the current column) from the drop-down menu. Symbols used are in accordance with LAD language description (item 5.2).

Inserting an input object:

Right-clicking inside the column A, C or E (cell 001 A in the example below) causes a drop-down menu to open – see Fig. 6.8.4.2.

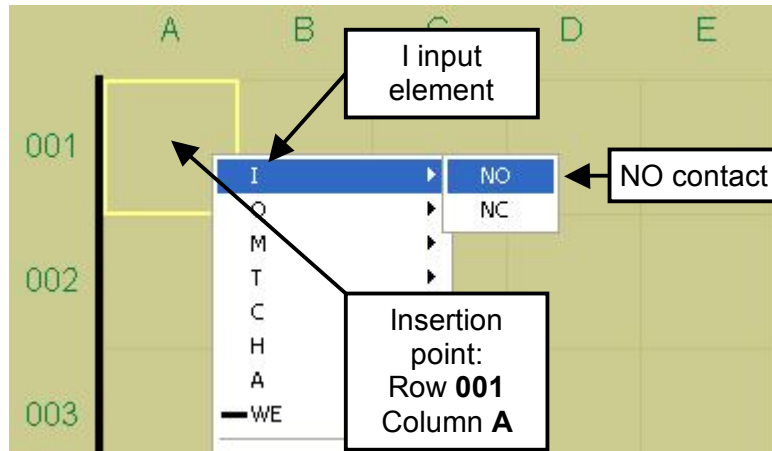

Fig. 6.8.4.2. Inserting an input object.

Left-click or press Enter to confirm the selection.

Inserting an output object

Right-clicking inside the column G (cell 001 G in the example below) causes a drop-down menu to open – see Fig. 6.8.4.3.

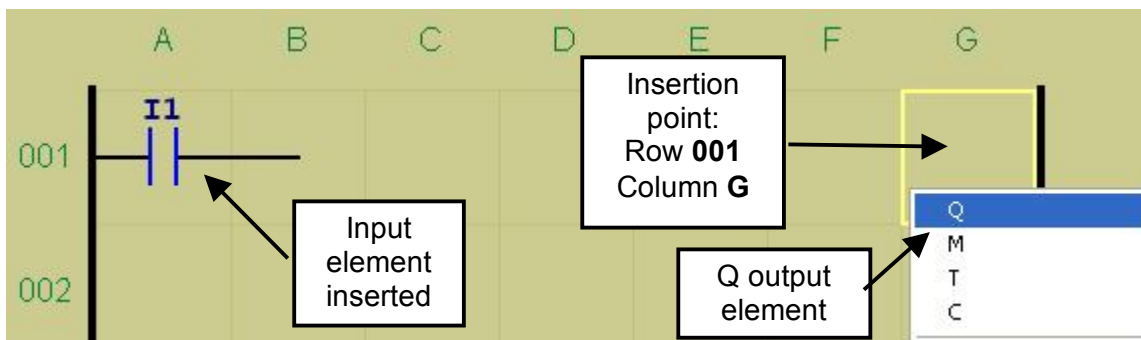

Fig. 6.8.4.3. Inserting an output object.

Deleting an object

An object can also be deleted. To this end select (mark) a cell where the object is located, select (highlight) **Delete** from the drop-down menu (right-click menu). Once the command is left-clicked the object will be deleted.

Inserting a connection

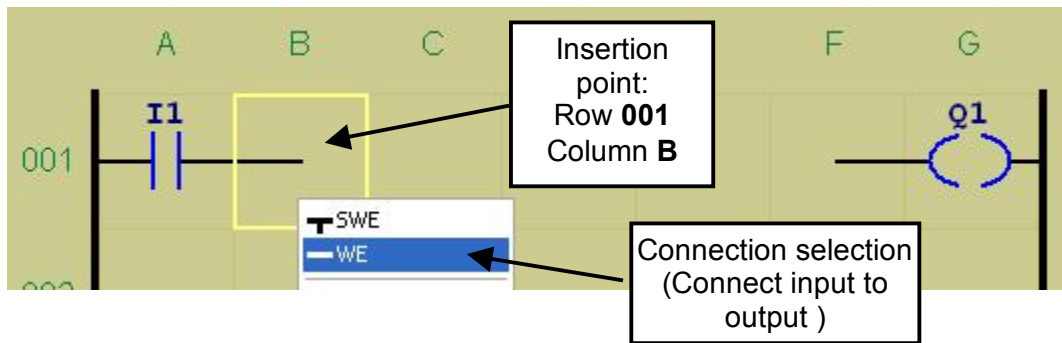

Fig. 6.8.4.4. Inserting a connection.

Once the connection cell is selected and the right mouse button is clicked the currently available connections are displayed in the drop-down menu. In addition to the graphic symbol an abbreviated direction symbol is provided which is a combination of letters S, W, N, E.

S – South (down)

W – West (left)

N – North (up)

E – East (right)

It is also possible to delete a connection. To this end select (mark) a cell where the connection is located, select (highlight) **Delete** from the drop-down menu (right-click menu). Once the command is left-clicked the object will be deleted.

Area editing

The PC Need program enables editing of the LAD project by deleting, moving and copying the selected area. The copy area is a rectangular made of the connection grid squares. The selection is made using left mouse button, while the right button opens the drop-down menu with a list of options.

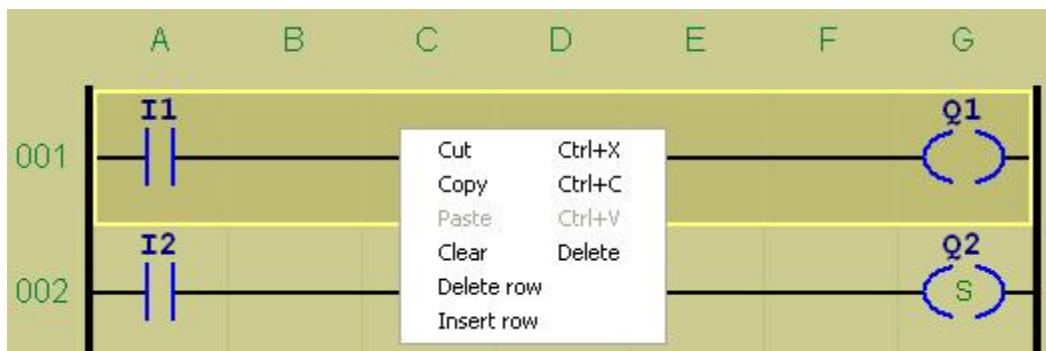
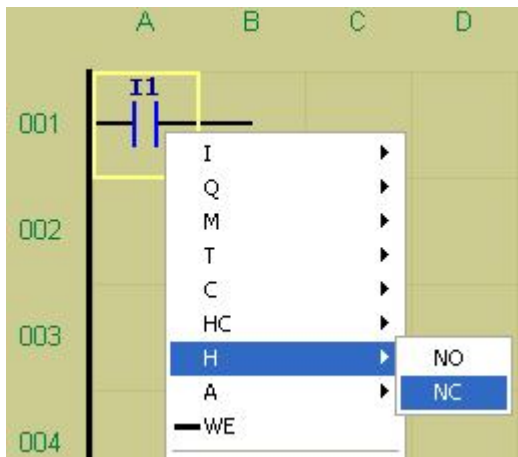

Fig. 6.8.4.5. Row selection and the choice of options.

- **Cut** – the selected (dark background) row or area may be moved elsewhere using the *Cut* option, and then by pointing to the starting left grid square of the target location and performing the *Paste* operation.
- **Copy** – the selected area may be copied elsewhere using the *Copy* option, and then by pointing to the starting left grid square of the target location and performing the *Paste* operation.
- **Delete** – the selected area may be deleted – the grid will be empty.
- **Delete row** – the selected row will be deleted.
- **Insert row** – an empty row will be placed in the selected location.

Changing the input type



Left-click the object cell to be changed (I1). Right-click to open the drop-down menu and select the object type (H) and contact type (NO or NC). Confirm the selection by clicking the left mouse button.

Fig. 6.8.4.6. Input type change.

Changing the output type

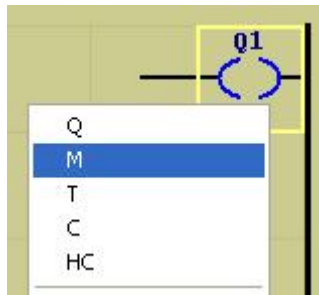

Left-click the object cell to be changed. Right-click to open the drop-down menu and select the new type (M). Confirm the selection by clicking the left mouse button.

Fig. 6.8.4.7. Output type change.

Following the above rules a program can be created as shown in Fig. 6.8.4.8 (below).

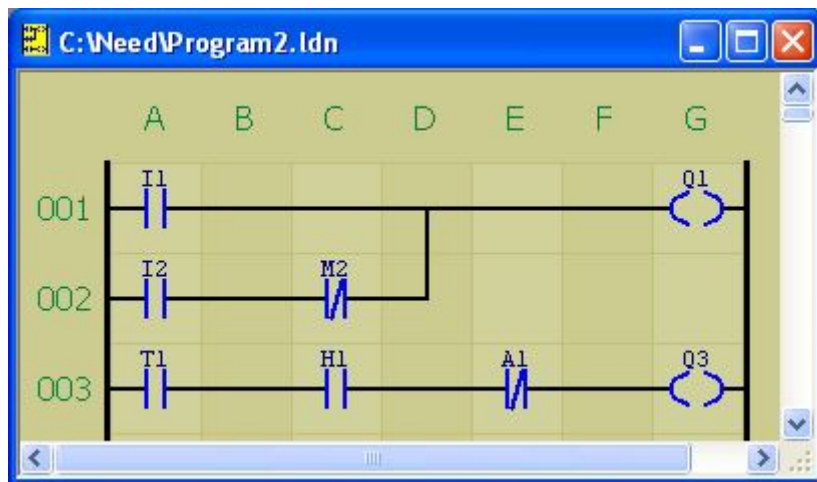

Fig. 6.8.4.8. Program in LAD.

The *Program2* file is linked to the “Settings” window (*Program2.ladn*) which is necessary to configure elements such as **Timer**, **Clock**, **Counter**, **Comparator**, **Remanence** and **Input delay**.

Values for Timers and Counters entered in the Settings are visible in the LAD diagram.

6.8.5. Edition of an object

Each object located in the diagram (connection grid) is editable. It is possible to change parameters, type and number of input, output, contact type.

Object configuration

Double-clicking of the left mouse button on the element located in the diagram calls the *Object configuration* window.

Fields available for change depend on the object type.

Input element:

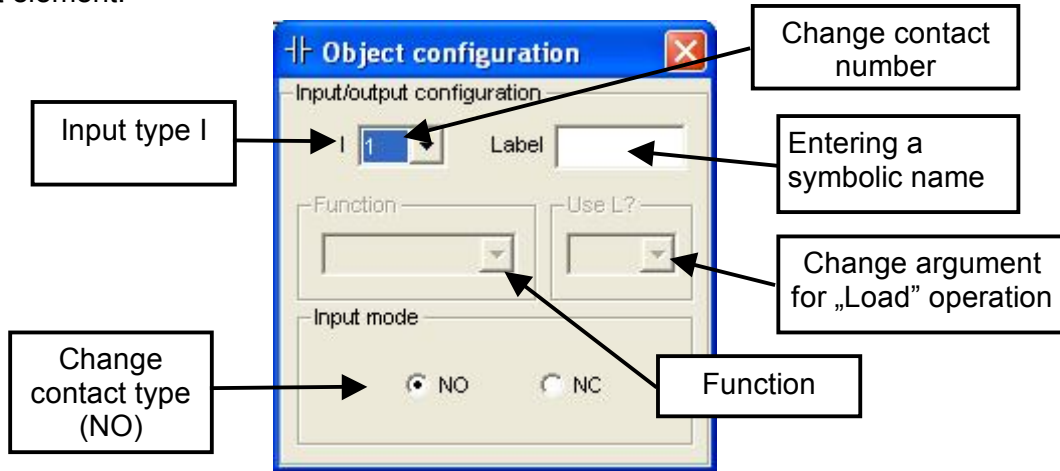

Fig. 6.8.5.1. Object configuration window.

Fig. 6.8.5.1 presents *Object configuration* for input I (physical input). Windows of other input types (A, H, Q, M, T, C) look similar. The number selection for a specific input type depends on the relay resources. Contact type (NO or NC) can be selected for each input.

The *Function* field is disabled for the inputs, as the field is used only for output objects.

Object configuration for Q output and M Marker.

Number of output (1..n or 1..16 if M was selected) and the function available depending on the output type, can be selected. For Q output and M Marker they are the following operands: =, S, R, FP.

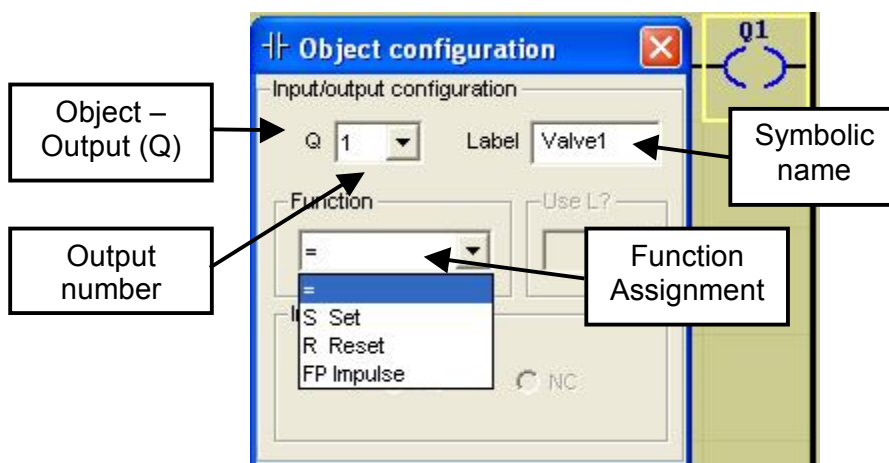

Fig. 6.8.5.2. „Object configuration – output” window.

The contact selection field is disabled for outputs in the *Object configuration* window while the *Function* field is enabled.

Object configuration for Timer output

The following parameters: number 1..n and operands: SD, SF, SE, SL, R can be selected for the *Timer* (T) output.

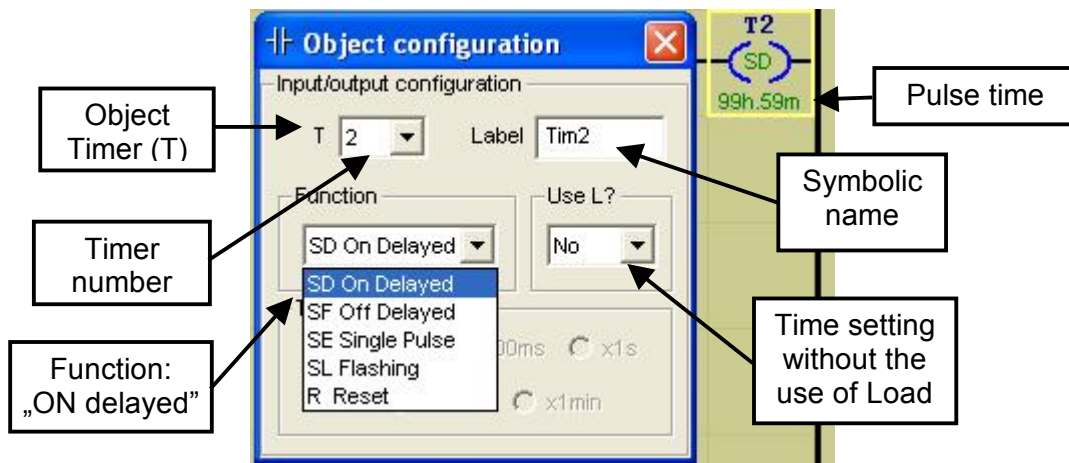

Fig. 6.8.5.3. „Object configuration – Timer” window.

If the option *Use “L” – Pot* is selected the clock multiplier and the value set by the Potentiometer are used for counting by the Timer. According to the example below, for the multiplier *x1* the value to be counted can be set within the range 1s...255s ((1-255)x1s). If the option *Use “L” – A17 or A18* is selected the clock multiplier and the value read from the 17 (or 18 for A18) analogue input are used for counting by the Timer. Values read from the analogue inputs are within the same range as those read from the Potentiometer i.e. between 1 and 255.

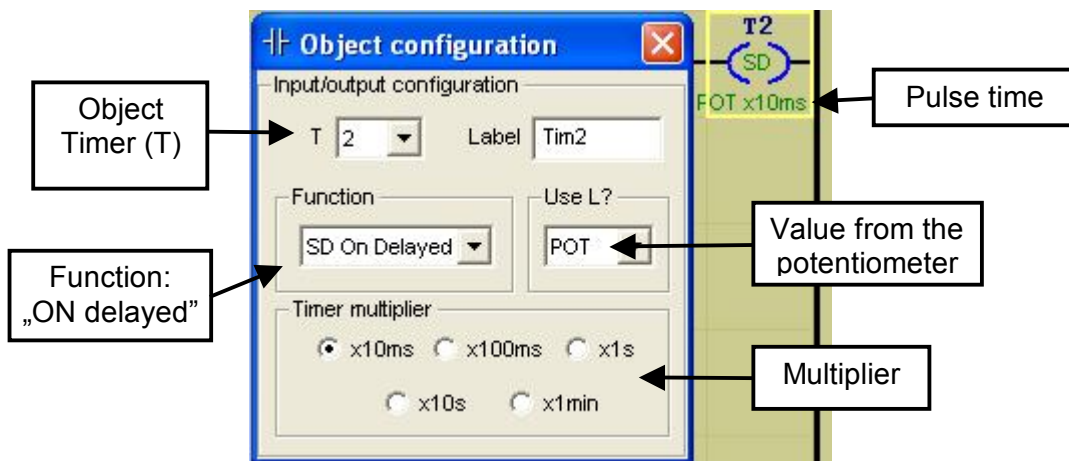

Fig. 6.8.5.4. „Object configuration – Timer POT” window.



Note: Time value can be changed in *Setting window*

Object configuration for Counter output

The following parameters: number 1..8 and operands: CU, CD, R can be selected for Counter (C) output.

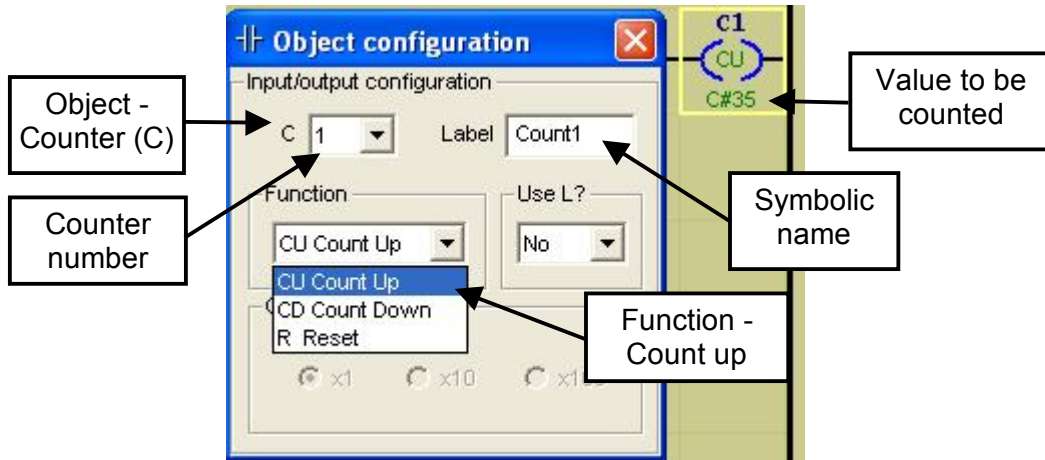

Fig. 6.8.5.5 „Object configuration – Counter” window.

If the option *Use “L” – Pot* is selected the clock multiplier and the value set by the Potentiometer are used for counting by the Counter. According to the example below, for the multiplier x1 the value to be counted can be set within the range 1s...255s ((1-255)x1s).

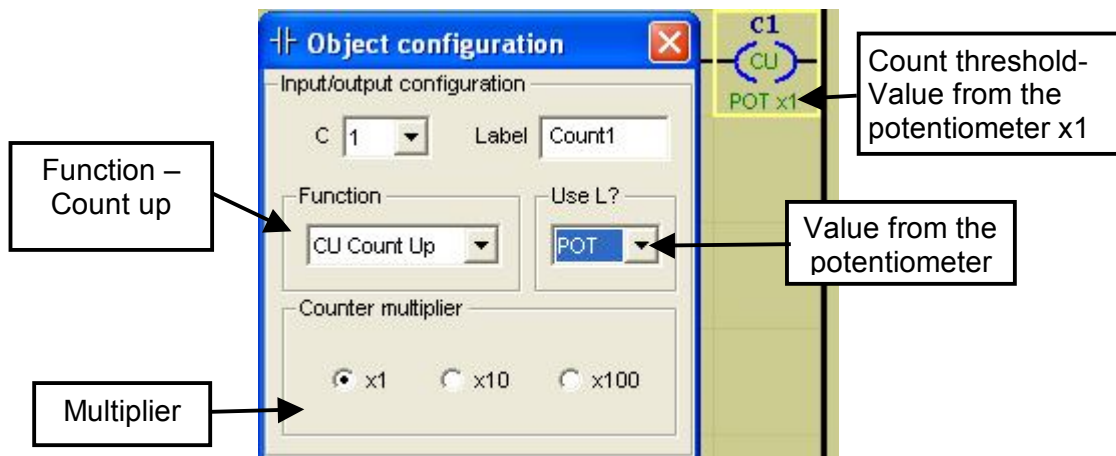

Fig. 6.8.5.6. „Object configuration – POT Counter” window.

If the option *Use “L” – AI7 or AI8* is selected the clock multiplier and the value read from the I7 (or I8 for AI8) analogue input are used for counting by the Counter. Values read from the analogue inputs are within the same range as those read from the Potentiometer i.e. between 1 and 255



Note: Value to be counted can be changed in *Setting window*

6.8.6. Comments

When editing the LAD program, you can add text comments to make it more clear, facilitate future modifications or provide other information, e.g. descriptions vital to the controlled process.

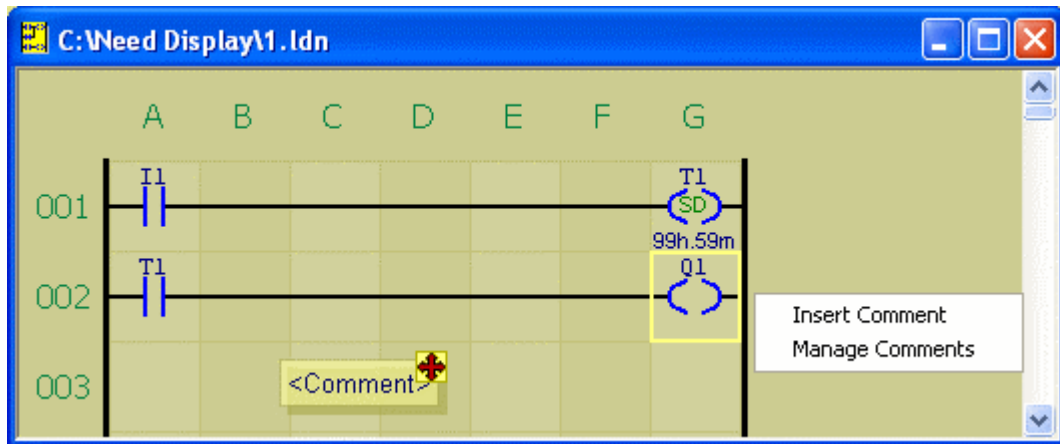

Fig. 6.8.6.1. Inserting a comment.

To insert a comment, use the pop-up menu available when you press the right mouse button. Use the "Insert a comment" option to create a new field <Comment>, which you can place anywhere in the LAD editor field. Press the left mouse button once to select a given comment. The selected comment will be highlighted with a border for easy identification. Double click it to open the comment field for editing. The same result can be achieved by selecting "Properties" from the popup-menu available when you press the right mouse button. There are also other options for controlling the comment field:

- Bring to front/Send to back – moves the comment in front of or behind program objects
- Remove selected – removes selected comments
- Lock/unlock selected – enables or disables comment movement
- Properties – opens the comment edit window.

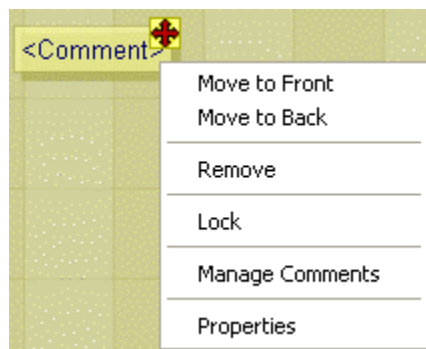

Fig. 6.8.6.2. Comment field options.

The "Comment properties" window allows you to enter the comment text as well as change its background, color and font. The size of the comment window is automatically adjusted to the text you enter. In addition, you can lock or unlock the possibility of moving the comment and set the transparency of comment field in relation to the program editor window. At any time, you can reset the edited item to its default values.



Note: When the LAD program is closed, comments are automatically locked.

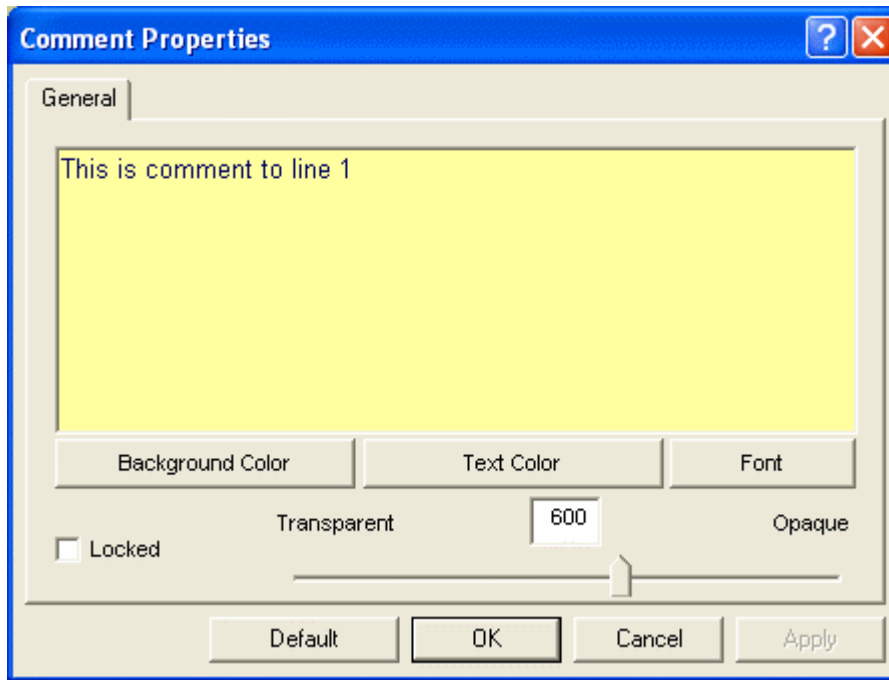

Fig. 6.8.6.3. Comment properties.

The “Manage comments” option (pop-up menu available when you press the right mouse button) allows you to view all comments in the program and remove or edit each of them, once you select the appropriate line and choose “Remove” or “Properties”.

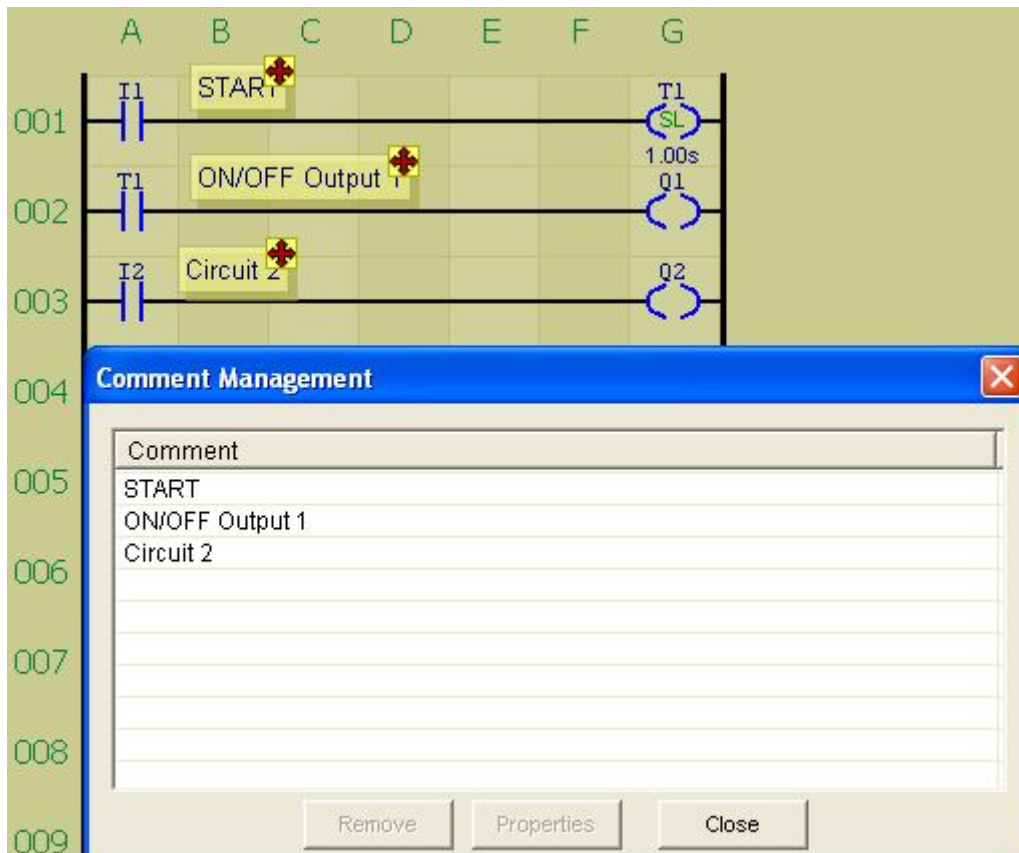

Fig. 6.8.6.4. Managing comments.



Note: You can select more than one comments.

6.8.7. Configuration of LAD editor

Appearance of editor window can be adapted to own preferences in **Configuration > Options** window, *LAD editor* tab.

The following can be set independently for each of EDITION, STOP and RUN modes:

- colour of background, window and connections columns
- grid colour
- colour of contact column background
- colour of cursor frame
- colour of background of highlighted area
- colour of connections
- colour of elements
- colour and font of resource type
- colour and font of symbolic names
- colour and font of function description
- colour and font of parameter description
- colour and font of column and row description
- colour of wrong connections and elements

(font - type, style, size, script).

Default settings can be restored any time.

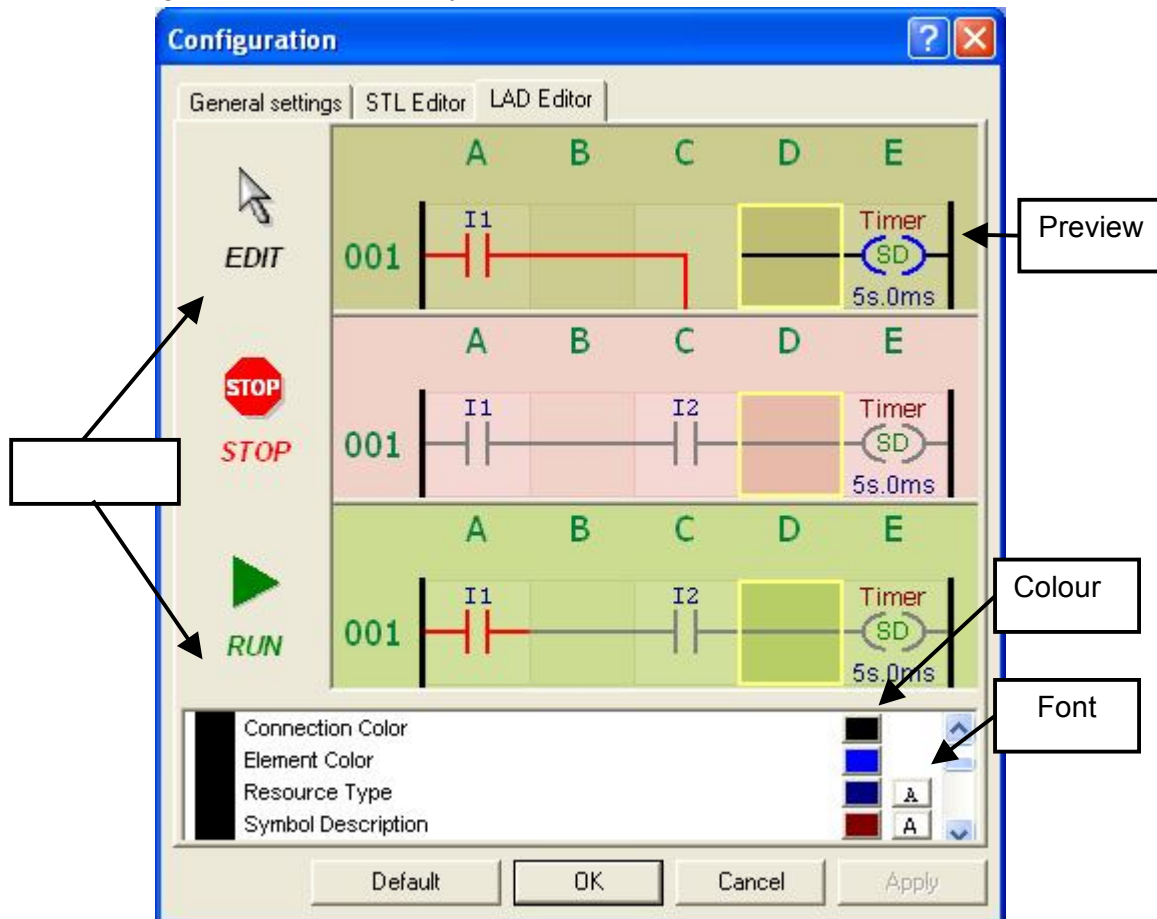

Fig. 6.8.7 Configuration of LAD editor

6.9. Settings

6.9.1. Types of settings

There are two types of settings:

1. Settings window linked to LAD program.
2. Settings file, independent

In the first case settings are made for the active LAD program window to store the program data.

In the other case file (or files) of different names can be created manually and they can be loaded to the relay memory to replace the former settings.

This is advisable if you want to change the Timers' times without changing the program. The new settings can be entered by editing the file without the need to perform a search in the program.

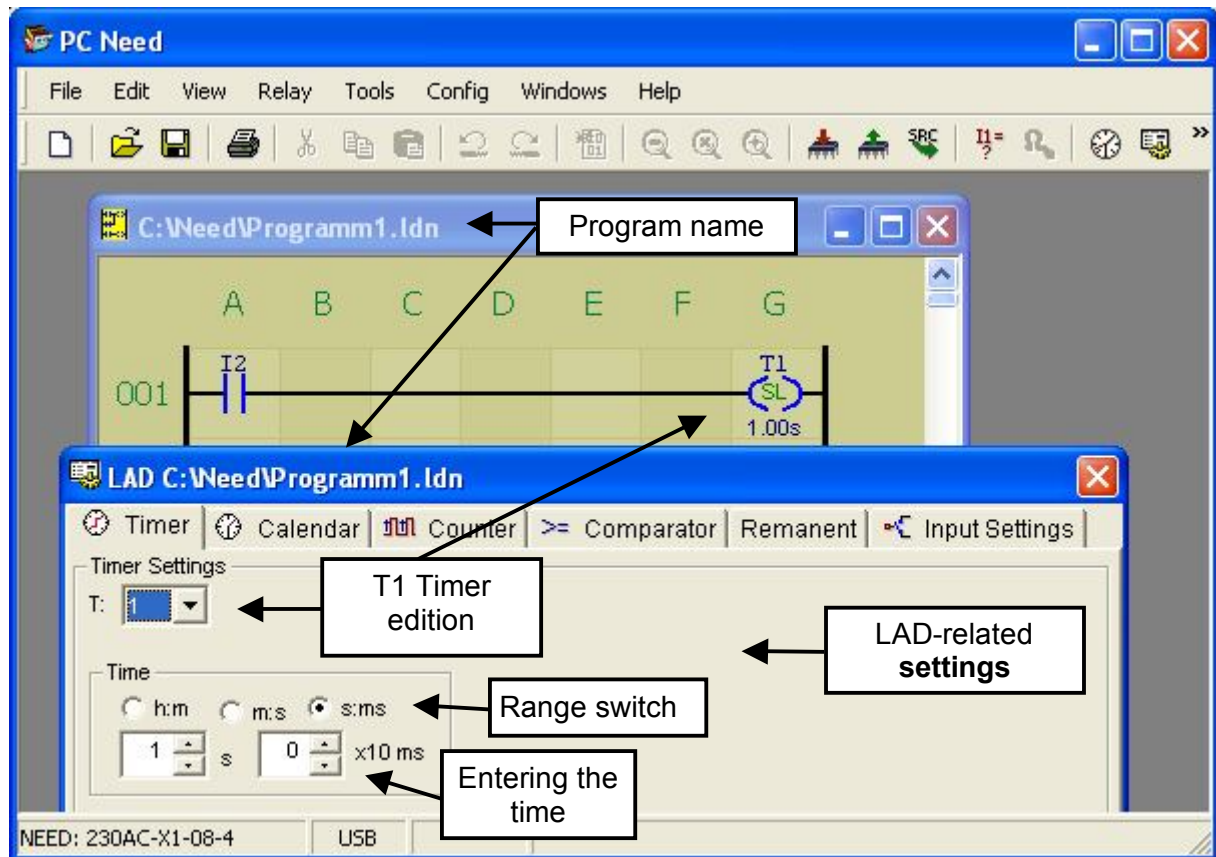

Fig. 6.9.1.2. LAD-related settings.

If the LAD program-related "Settings" file is not loaded, the program in the relay will be executed using recent settings present in the relay.

After the reset they will be: the maximum values of Timers and Counters, reset Clocks, no remanence and enabled input delays.

In order to access Settings in the LAD program edition click the icon in the toolbar or alternatively select **Relay > Settings** (or press F10 key). Fig. 6.9.1.2. illustrates the result of executing that command and editing the Timer 1 (SE mode, time: 1s).

In order to create a new SET file select **New** in the **File** menu and check **Settings** in the *Create new project* window and select the relay type.

Settings pertaining to the LAD program are stored automatically when the program is saved, if the option is enabled in the LAD project configuration

Settings created manually must be saved, as in the case of LAD or STL, and named.

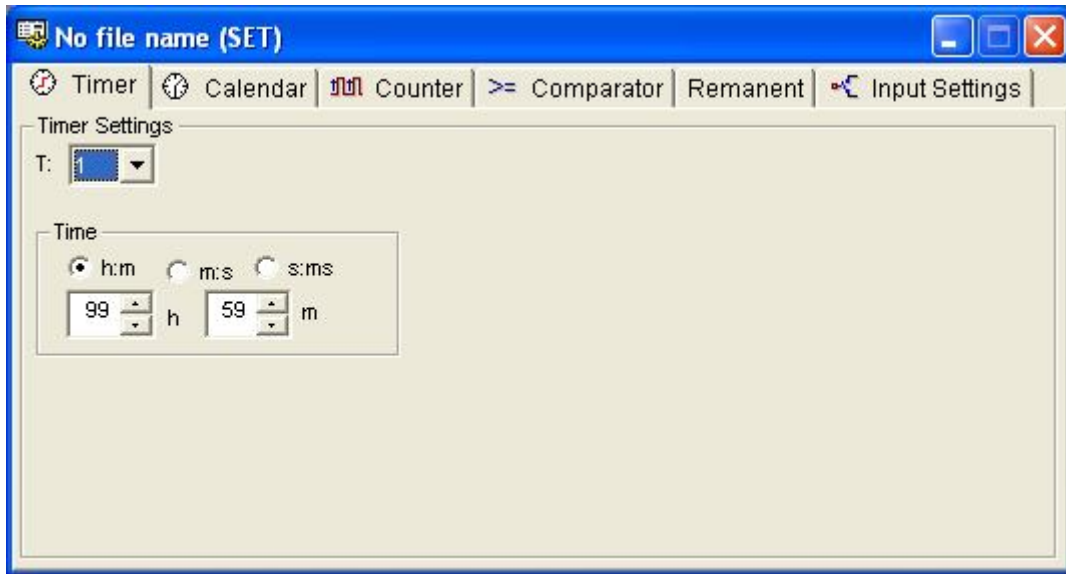

Fig. 6.9.1.3. Newly created settings file (SET).

The default extension of the Settings file saved to the disc is `“.set”`. The basic differences between the LAD program-related settings and the manual file of `Program1.set` are presented below.

Note: Settings file is loaded independently from the program. By default, a program and, subsequently, settings related to it are loaded in the PC NEED program for the LAD editor.

Automatic loading of settings can be disabled by using the following menu options:
Configuration > LAD project.

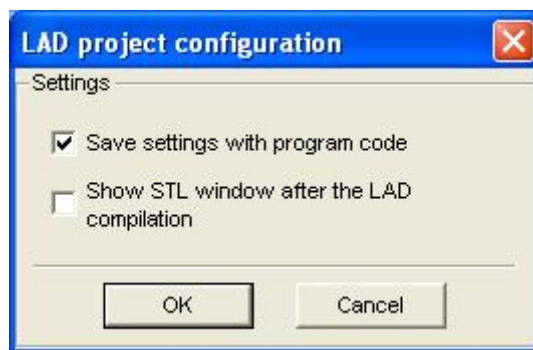
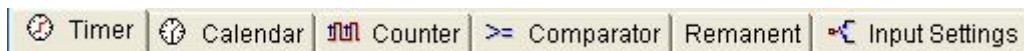

Fig. 6.9.1.1. LAD project configuration.

Type of variables to be set can be selected by using the tabs:



The *Settings* window associated with the LAD program can only be closed using **✕** while the SET file has also the icons **▢** **▣**.

Except for the name and association the edition of settings is identical as it consists in filling the described fields or selecting values from drop-down menus.

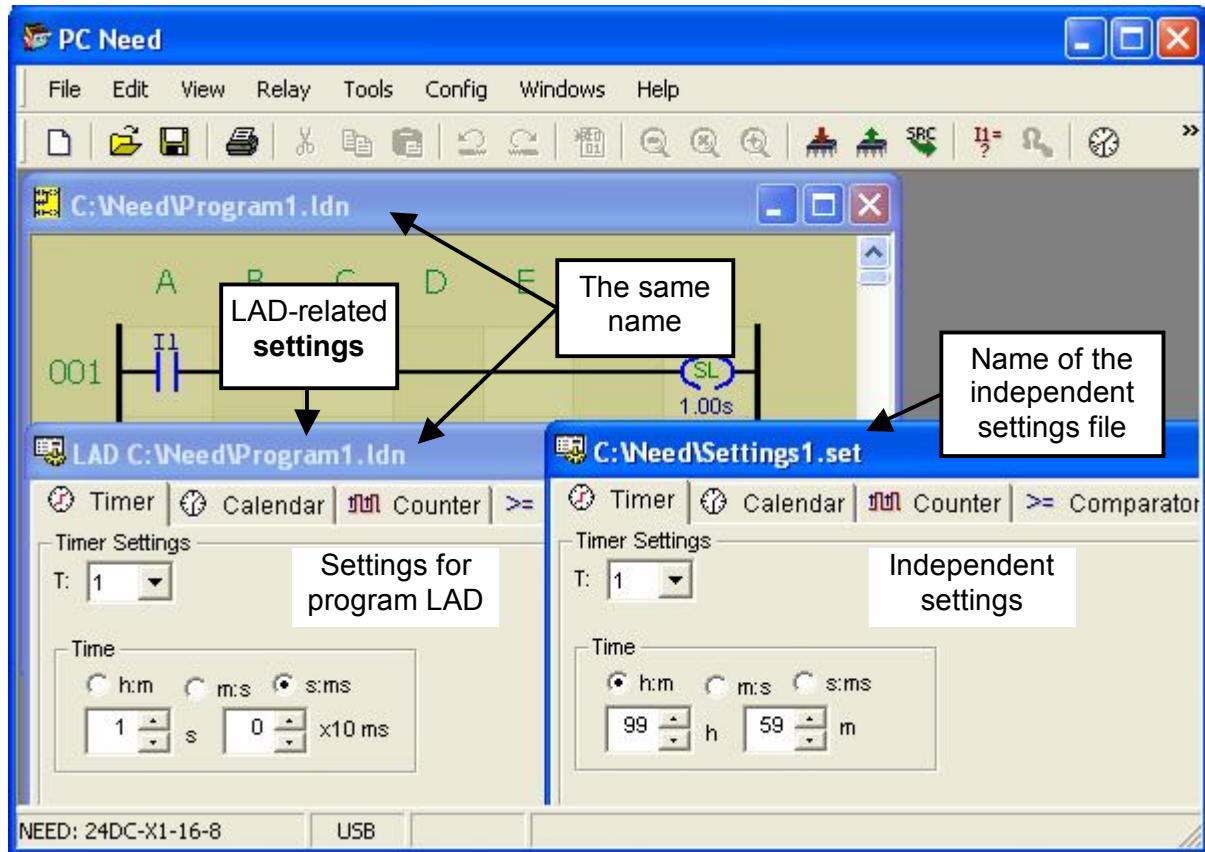

Fig. 6.9.1.4. Differences in settings.

6.9.2. Timer settings

Select the Timer number, assign a range to it (hours: minutes, minutes: seconds, seconds: milliseconds x 10) and enter the set time value in the editable fields.

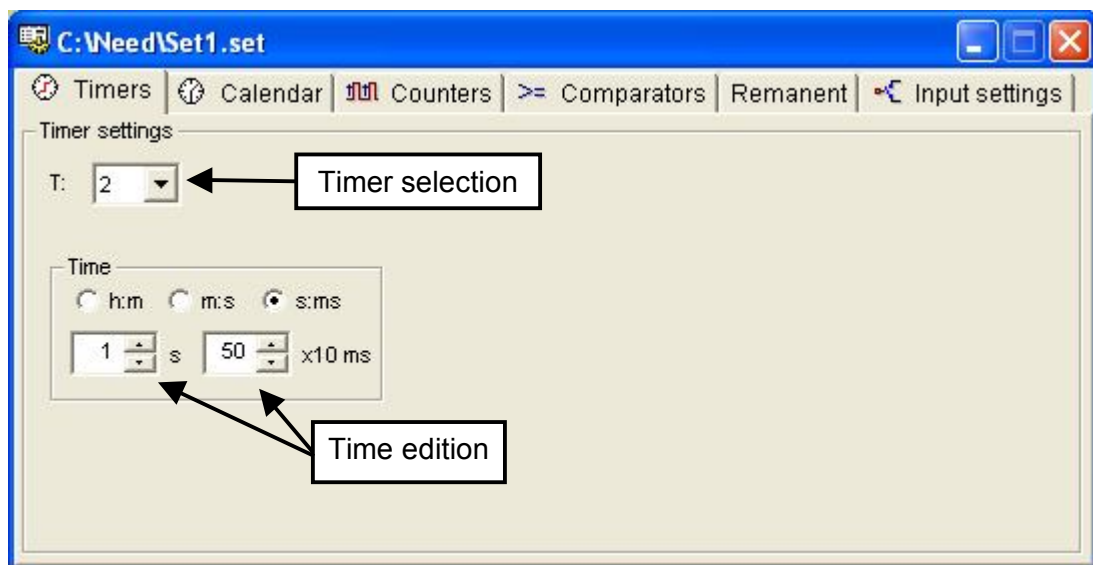

Fig. 6.9.2.1. Settings of Timers.

6.9.3. Clock settings

Select the Clock number (H1..H4) and edit the selected channels A..D by setting week days, hours and minutes.

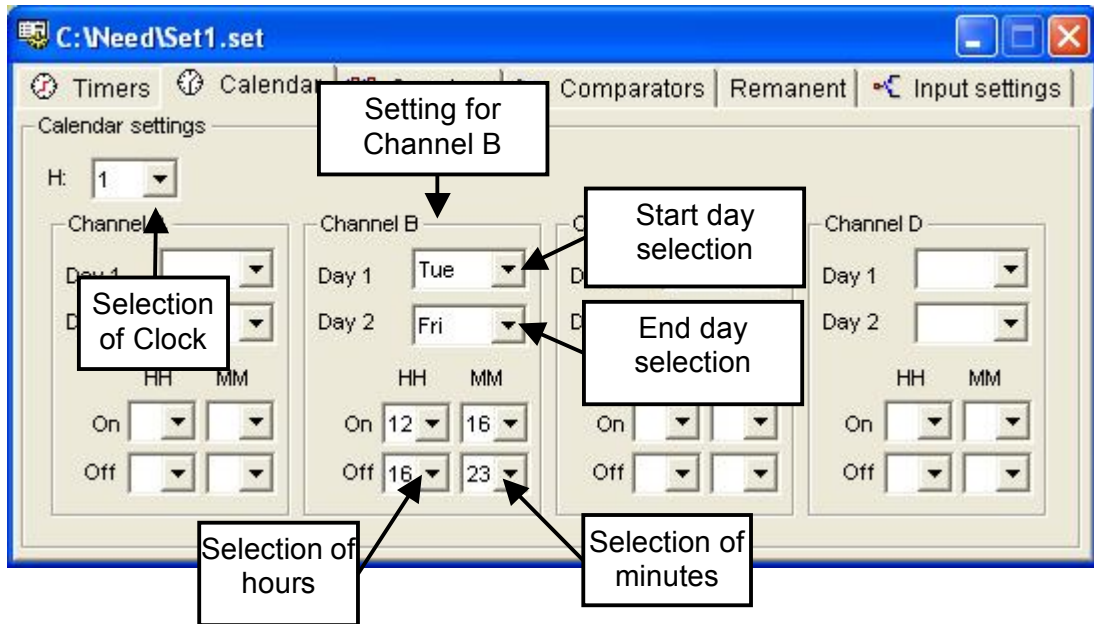

Fig. 6.9.3.1. Clock settings.

6.9.4. Counter settings

Select the Counter number and enter the value to be counted.

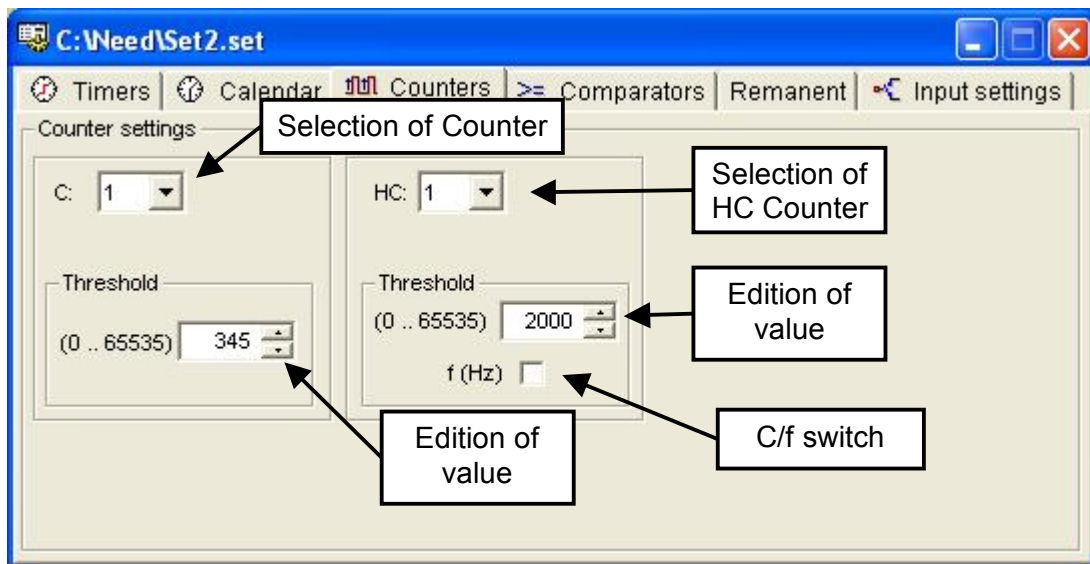

Fig. 6.9.4.1. Counter settings.

6.9.5. Comparator settings

Select the Comparator number and assign a comparison type to it, and enter the voltage value in volts for the comparisons with the permanent value.

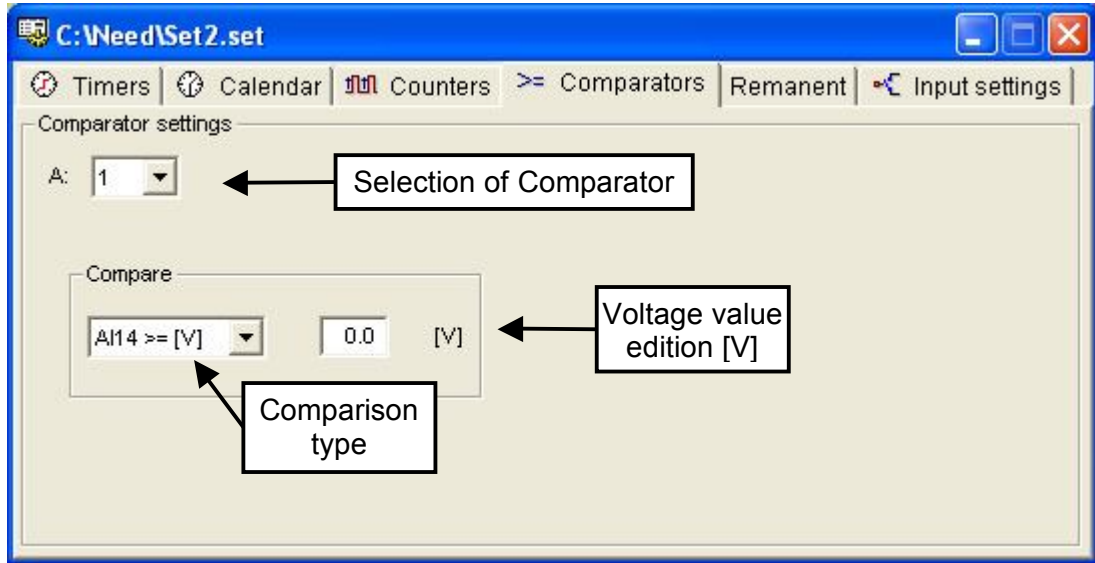

Fig. 6.9.5.1. Comparator settings.

6.9.6. Remanence

The variable to be remanent is selected by selecting the variable check box (Fig. 6.9.6.1 - M1, T5, T6 and C8 were selected as remanent).

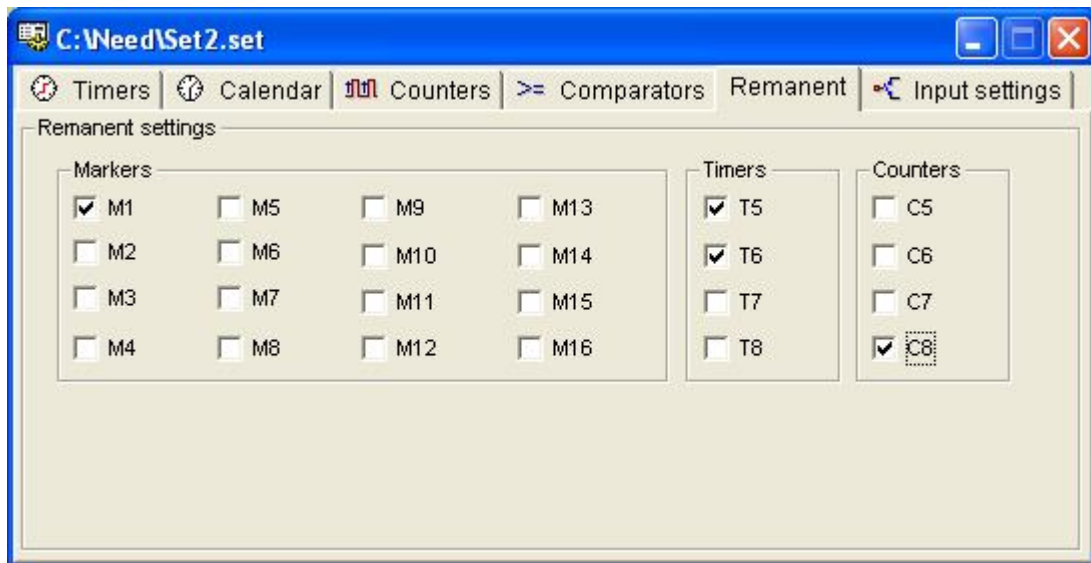

Fig. 6.9.6.1. Remanence settings.

6.9.7. Input delays

If the input is to be scanned without a delay its checkbox must be deselected (I7..I13 input in Fig. 6.9.7.1. will not be delayed).

By default inputs have their checkboxes selected – input delay is on.

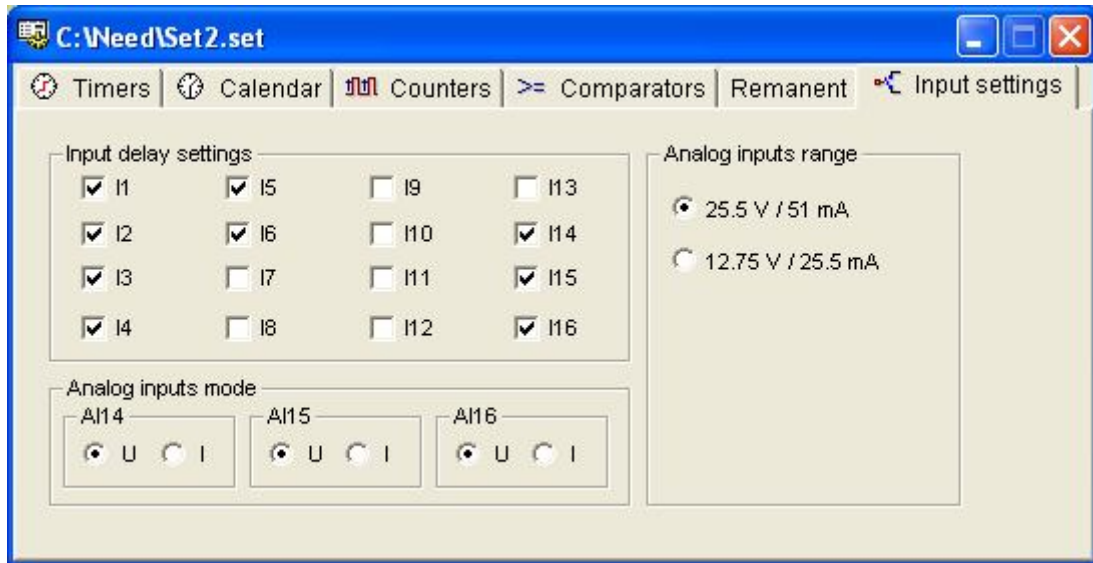

Fig. 6.9.7.1. Input delay settings

6.9.8. Text Markers

The Settings form is slightly different for relays with an LCD display – it includes an extra tab for editing the text of information displayed when its corresponding MTx Marker is set.

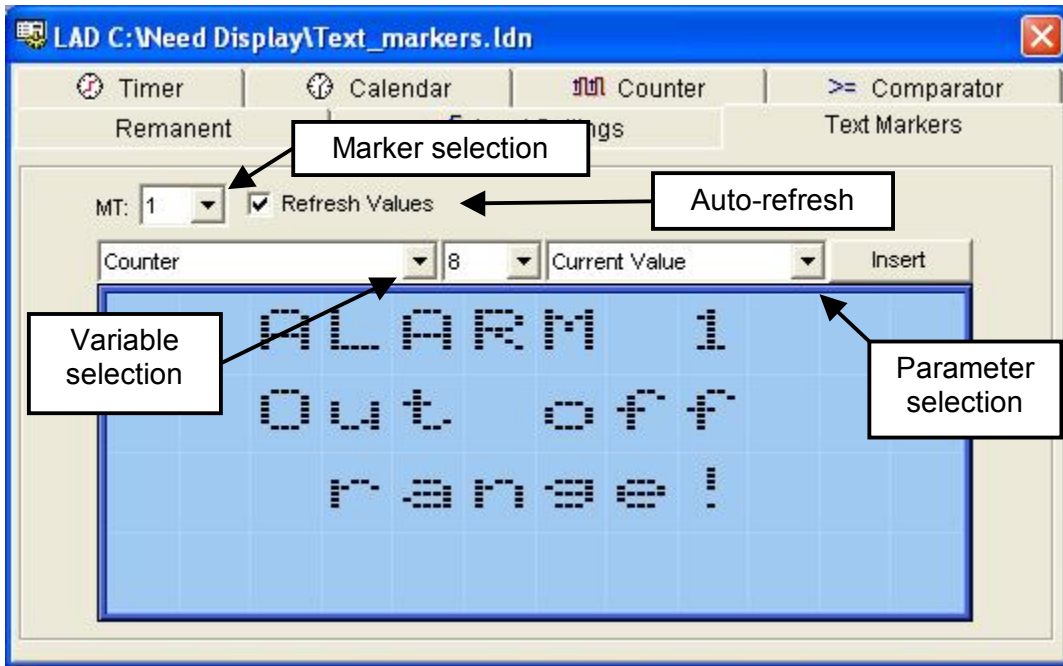

Fig. 6.9.8.1. Settings - Text Marker

The Text Marker editor reflects the display field shown on the NEED Display relay. It allows you to enter characters (text) and parameters (variables).

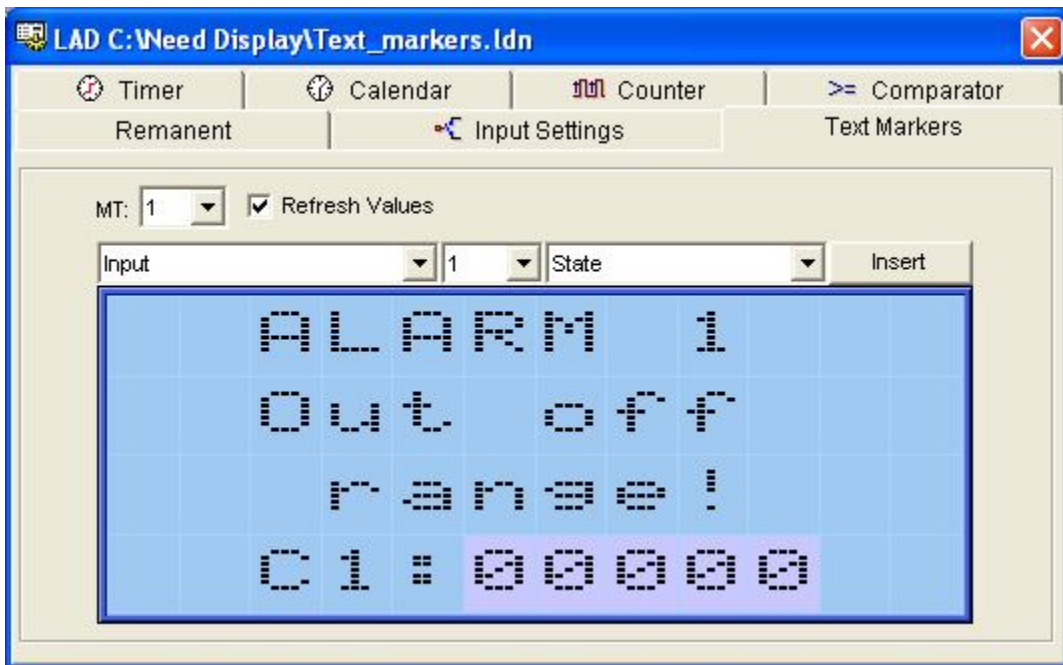

Fig. 6.9.8.2. Inserting Counter values

Variables that can be inserted in a given relay type are available for selection in the drop-down list on the left. Fig. 2 (Counter selected). Specify the parameter to be presented for

each variable. For binary variables (Inputs, Outputs, Markers), only State is available. For other variables, e.g. Counter, you can select: State, Current value, Set value.

“Refresh values” radio button (checked by default):

- When displaying the MTx screen, variable values are automatically refreshed.
- Variable values are fetched upon MTx activation and are not updated afterwards.

6.10. Preview of variables

PC Need is equipped with a tool for monitoring all variables in the relay.

To open the Preview window go to: **Tools > Variables preview** or use this button .

Keyboard shortcut: F12.

If a connection was established with the relay, a continuous preview of variables entered can be started by using the button  (Reading) or going to: **Relay > Transmission > Read from the relay** (keyboard shortcut: F6).

Selection of variables to be previewed is made by entering those variables in the *Res. Number* column. Fig. 6.10.1. illustrates the entering of I3 variable. In order to enter a new variable double click the left mouse button or press *Enter* on the first free cell in the *Res. Number* column. Mnemonic utilized for writing of programs and the following symbols are used:

POT – Potentiometer

AI7, AI8 – voltage values at the input terminals (I7 and I8 respectively).

AI14, AI15, AI16 – voltage values at the input terminals (I14 and I15 I16 respectively).

RTC – Real-time clock.

HC – fast meter/gauge of frequencies 0-20 kHz.

MDIR – system phase direction marker

The green highlight color in the *Variable* column and the Online label on the status bar, highlighted with green color, means the relay operates in the RUN mode.

Red highlight color signals the relay's STOP mode.

The binary variables with the value "1" in the *Status* column are highlighted with green color.

The connection with the relay is signaled on the status bar:

- For active view of variables and RUN mode:

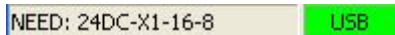

- For active view of variables and STOP mode:

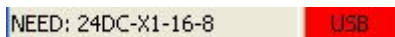

Variable	State	Current	Set	Other
Q1	1			
M1	0			
H1	0			
C1	0	0	65535	
T1	1	4.01s	10.00s	SL
A1	1			AI14 >= 0.0
HC1	0	0	65535	HC
RTC		30/09/2008 12:28:50		
AI7				
AI8				
AI14		12.4V		
AI15		7.5V		
AI16		22.2V		
MDIR				
ASYM				
I4	0			

Fig. 6.10.1. Preview of variables.

The variable entered can be changed or replaced with another one.

The *State* column shows the read value of 0 or 1 for binary variables.

The *Current* column indicates current values of Timers and Counters or a numerical value for POT, AIn. In case of RTC date and time are given in the format of day/month/year hour: minute: second.

The *Preset* column lists the preset values of Timers and Counters.

The *Other* column shows additional information such as Timer mode, comparison type of the Comparator etc.

The T1 row of the Preview table shown in Fig. 6.10.1 includes information saying that the Timer state is 0, there is 4.01s left to be counted, the preset time is 10s and the Timer is set to the pulse generation mode (SL).

6.11. LAD ladder view

PC Need makes it possible to view the running of the LAD program in the relay.

If connection with the relay is active, then by clicking the right mouse button, in the active window of the LAD program you can display a menu from which you can choose the *Ladder view*.

Connection with the relay is indicated with a flashing word *Online* on the status bar:

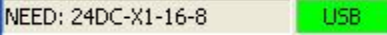
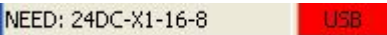
- For active LAD view and RUN mode: 
- For active LAD view and STOP mode: 

To stop the ladder view click the right mouse button on the right mouse button and select

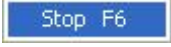
. You can also press F6.

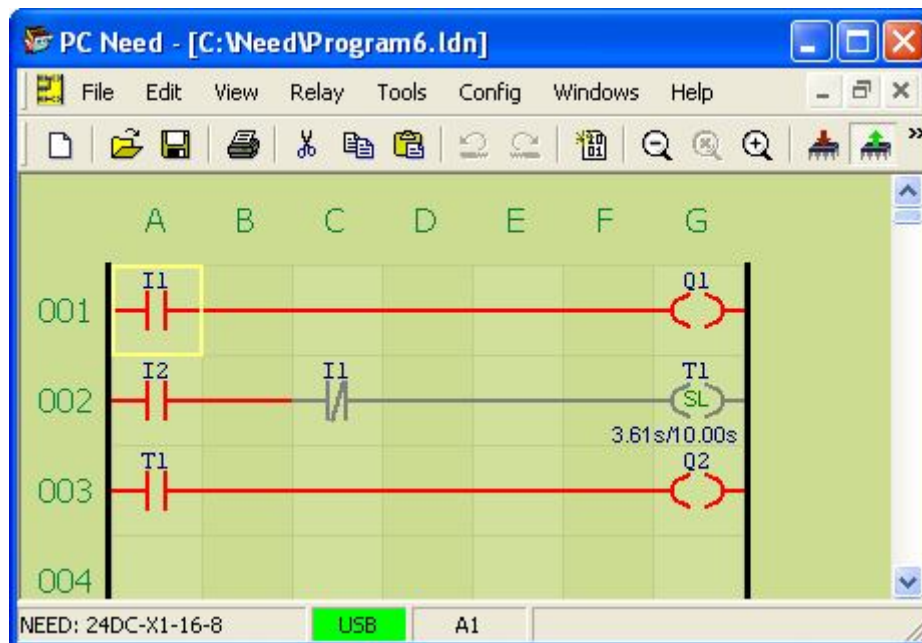

Fig. 6.11.1. Ladder view window

In the ladder view the active items or circuits are red, the inactive ones are black. In fig. 6.11.1 the active circuits are 002, 003. Circuit 001 is inactive because I1 input condition is "0". In the 002 circuit the I1 input is of NC type, its status is "0". From the LAD point of view it is active. Additionally information is displayed about the current and set time value of the *Timer*. For *Counters* the counted value and the set threshold is indicated. In the STOP mode the ladder is inactive, it cannot be viewed.

6.12. Password

In order to prevent access by unauthorized persons the NEED programmable relay can be protected with a 4-digit password (0 to 9999).

If a password is to be used when programming the NEED relay, select “Do not ask for password” in **Menu > Config > Options** (Fig. 6.12.1).

Default password is 0 (zero).

The password is stored in the EEPROM memory of the relay.

Relay reset restores the default password.

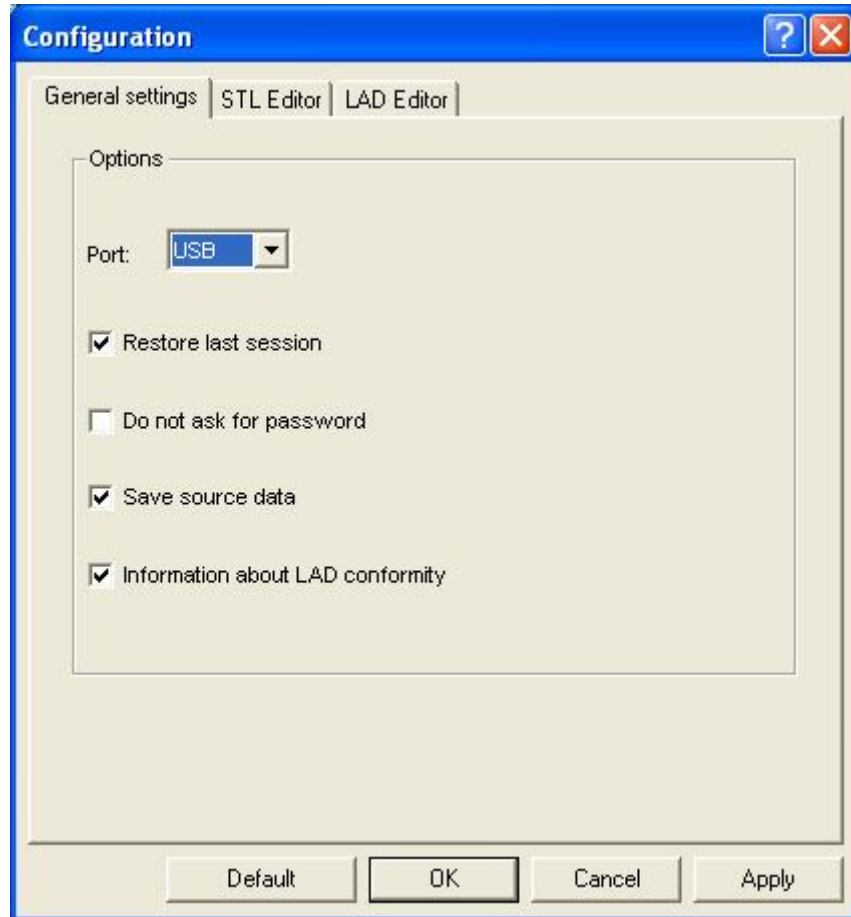

Fig. 6.12.1. Enabling the asking for password.

6.12.1. Password entering

If the option „Do not ask for password” is not selected, when starting PC Need programme the password to establish communication with NEED relay must be entered. Password can be entered using **Menu > Relay > Password > Enter** or when prompted once the command on the communication with the relay is used. If the password is not set (password: 0) it is sufficient to accept the command; the command will be executed.



Fig. 6.12.2. Password entering window.

6.12.2. Changing the password

In order to set or change the existing password select: **Menu > Relay > Password > Change**. Enter the valid password (current password) (see Fig. 6.12.2.) and the new password to be used (New password). Additionally, the new password is to be re-entered in the „Verify password” field in order to avoid any typing mistakes. The password is saved in the relay memory.



Fig. 6.12.3. „Change device password” window.



Note: The password is stored in the relay memory. Resetting the relay causes the password to be reset and set to default (password = 0).



Note: When using an external memory to program the relay, the external memory password must be identical to that of the relay. If the passwords are different the relay will not respond to the external memory.

The external memory password is the one which was set in PC Need during the programming.

6.13. Real-time clock (RTC)

To open the RTC window go to **Menu > Relay > Clock** (Ctrl+Shift+Z on the keyboard) or use the icon  in the toolbar.

It is also possible to preview the current time in the relay– *Read* button, to set any date and time and use the *Save* button and to set the current time of the programming device (PC) by means of the *Synchronize* option.



Fig. 6.13.1. Real time clock window.

The *Time zone* check box makes it possible to set automatic change of winter to summer time and the other way round depending on the geographic location. The *None* option means that the relay will not take any time changes into account.

6.14. Source code

In the NEED ...-16-8 version relays it is possible to save the source code directly in the relay. It is not possible to load the code into an external memory.

The source program is loaded during transmission to the relay immediately after the executable code and settings are loaded.

Loading of the source code is set by default. You can disable storing source code in the relay, by unchecking the option "Save the source data" in the **Config > Options**.

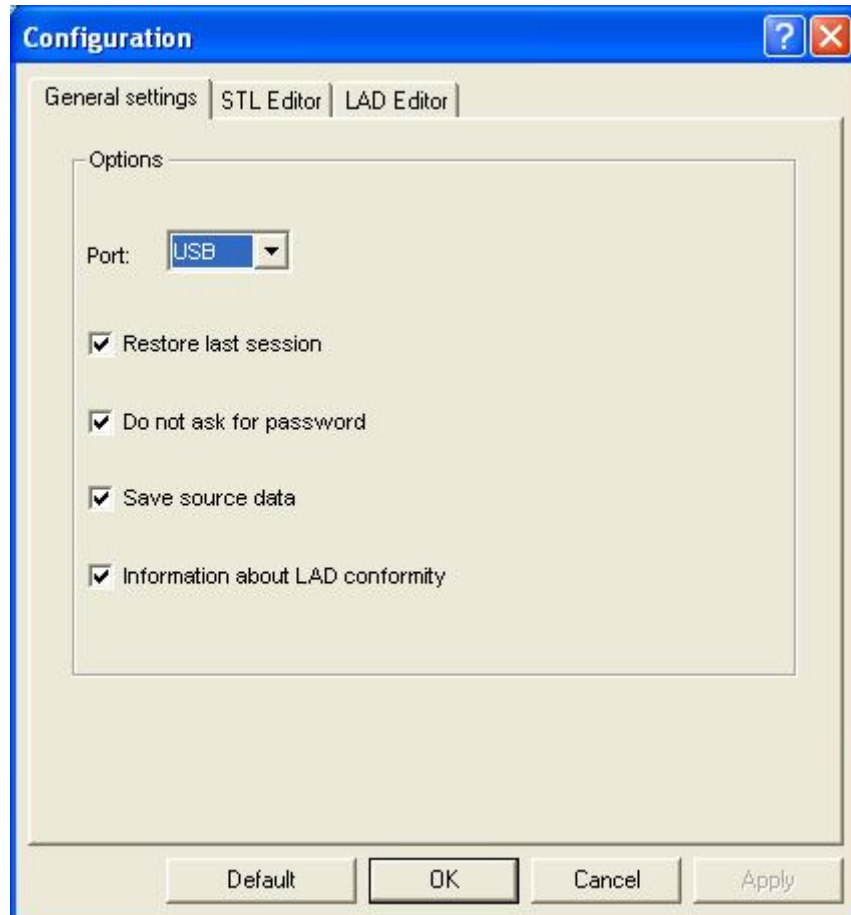

Fig. 6.14.1. The Program Configuration window.

Source code can be read from the relay through the **Relay > Transmission > Read the Source Code** or using a button.

After retrieving the project contents PC Need automatically opens a new window in the editor (LAD, STL) in which the program loaded to the relay was authored.

6.15. Document conversion

Both LAD and SET programs enable automatic transfer of program code and settings between different relay types. Of course, full conversion is not available in all cases due to different relay resources – see conversion details for more information

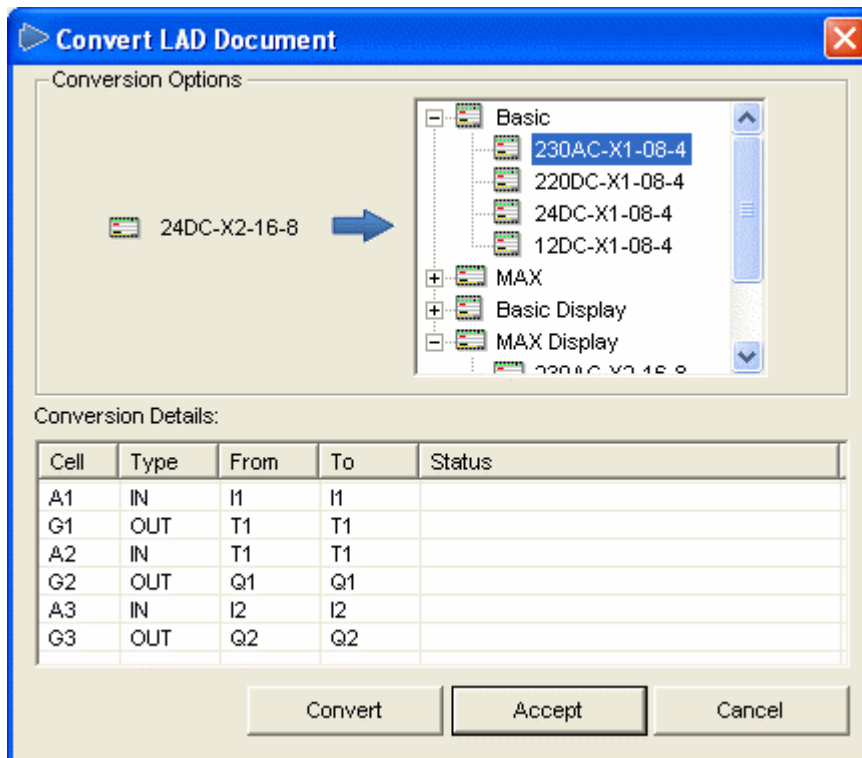

Fig. 6.15.1. "Convert a LAD document" window

Each target resource in the "Conversion details" table can be changed or assigned a new value when the "Resource missing" alert occurs. The alert concerning a missing resource requires you to remove all resources that do not have their counterparts in the target program. For example, when converting a program using MT Markers (NEED with display) to a version without display, you have to remove them.

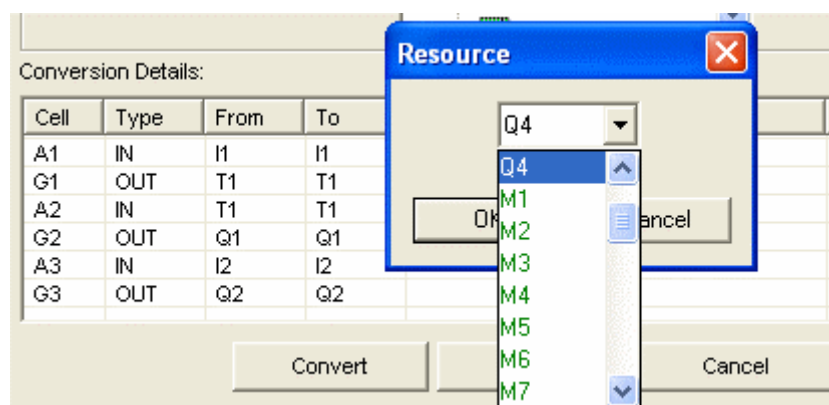

Fig. 6.15.2. Changing a resource.

Fig. 6.15.2. shows the available options for changing the G2 cell (Com. column), i.e. replacing the WY output (Type column) from Q1 (From column) to Q2 (To column). available to the target relay type are transferred – others are set to default values.

When it comes to settings, conversion is fully automatic. Once you enter and accept target type in the active Settings window, a new document will be generated. Only the settings available to the target relay type are transferred – others are set to default values.

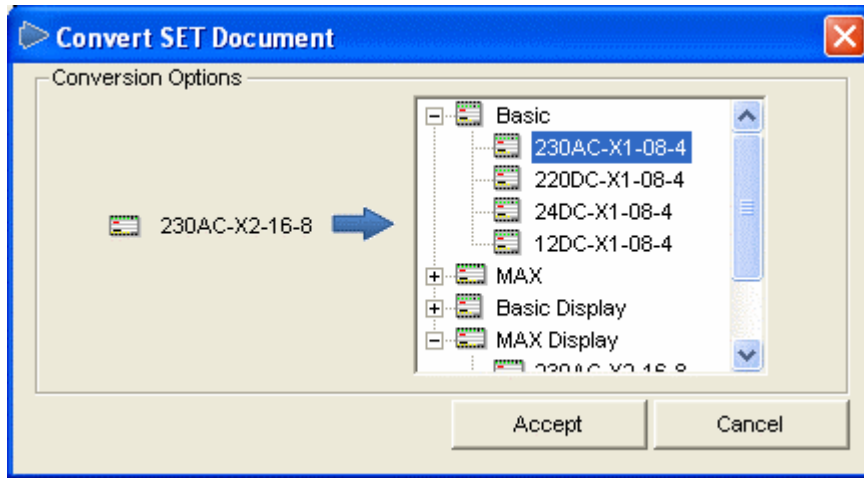

Fig. 6.15.3. Converting Settings.

7. START-UP

7.1. Switching on

7.1.1. Preliminary operations for the AC version.



1. Check if the power is connected properly:
terminal L: phase conductor 230V AC
terminal N: neutral conductor
2. Check if the relay inputs and outputs are connected properly;
Caution: I1.. In inputs are controlled by the phase conductor L
3. Set the RUN/STOP switch to STOP.
4. Protect the circuits controlled by the programmable relay against unauthorized access – when started up for the first time there is a risk of uncontrolled operation of machinery (drives, pumps, fans) and devices or of dangerous voltages being present at the inputs. This may be caused by e.g. a program error or wrong cable connections.

7.1.2. Preliminary operations for the DC version.



1. Check if the power is connected properly:
 - terminal +24V DC: positive supply conductor 24V DC
 - terminal +12V DC: positive supply conductor 12V DC
 - terminal +220V DC: positive supply conductor 220V DC
 - terminal 0V: power supply ground
2. Check if the relay inputs and outputs are connected properly;
Caution: I1.. In inputs are controlled by the voltage positive in relation to 0V terminal
3. Set the RUN/STOP switch to STOP.
4. Protect the circuits controlled by the programmable relay against unauthorized access – when started up for the first time there is a risk of uncontrolled operation of machinery (drives, pumps, fans) and devices or of dangerous voltages being present at the inputs. This may be caused by e.g. a program error or wrong cable connections.

7.1.3. Turning the power on.

1. Connect external power supply to the programmable relay terminals.
2. Check the functioning of independent safety instruments (if any) – e.g. emergency power off switch.
3. Check if the signaling of the programmable relay inputs by LEDs is proper.
4. Switch the RUN/STOP switch to RUN.

Monitor the functioning of the system – in case of malfunctioning check the connection system and the control program.



NOTE: Once RUN mode is selected, the program is activated that takes control over the outputs.

8. INFORMATION ON HARDWARE

8.1. Relay power supply.

8.1.1. Relay 115/230 V AC power supply

Schematic diagram of the NEED relay power supply circuit is presented in Fig.8.1.1

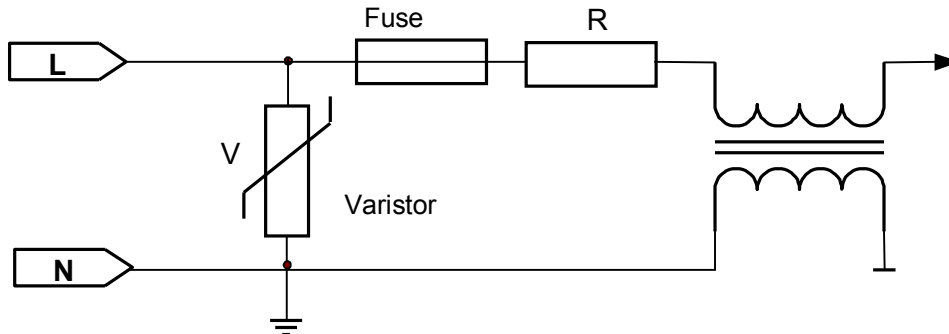

Fig.8.1.1. Schematic diagram of the NEED AC relay power supply circuit.



The NEED relay power pack circuit is not electrically isolated from the mains power supply. This means that, should the conductors connected to L and N terminals be interchanged, voltages dangerous to life can be present at the communication terminal.

8.1.2. Relay 220 V DC power supply

Schematic diagram of the NEED relay power supply circuit is presented in Fig.8.1.2.

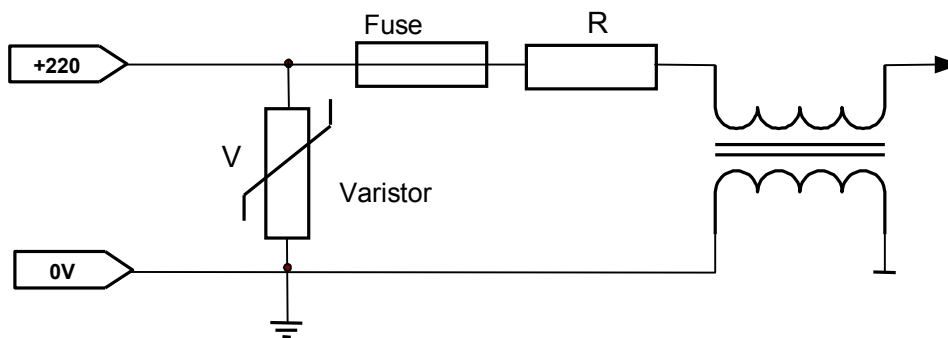

Fig.8.1.2. Schematic diagram of the NEED AC relay power supply circuit.



The NEED relay power pack circuit is not electrically isolated from the mains power supply. This means that, should the conductors connected to 220V and 0V terminals be interchanged, voltages dangerous to life can be present at the communication terminal.

8.1.3. Relay 24 (12) V DC power supply

Schematic diagram of the NEED relay power supply circuit for the 24V DC version is presented in Fig.8.1.3. The 12V DC version differs in components selected.

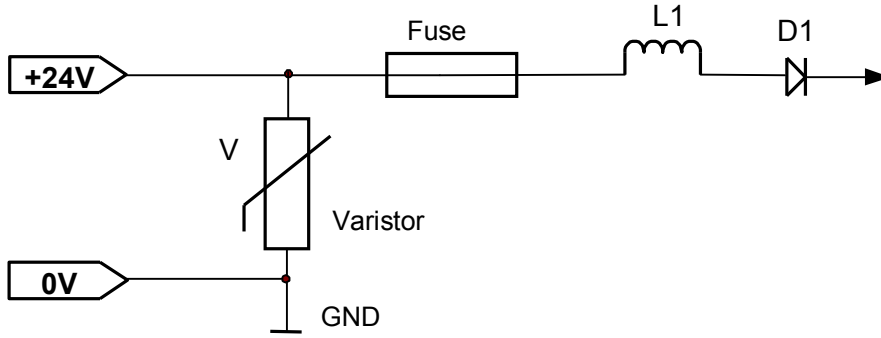

Fig.8.1.3. Schematic diagram of the NEED DC relay power supply circuit



The relay power supply systems in the DC version are protected against reverse connection of supply voltage.

8.2. Inputs

8.2.1. 230 V AC inputs

Concept diagram of the NEED relay input systems is shown in Fig. 8.2.1 and Fig. 8.2.2. Analog inputs are I7 and I8 for the DC NEED..-xx-8-.. version and I14, I15, I16 for the NEED..-xx-16-.. version.

Inputs with increased resistance to interference are I5 and I6 for the AC NEED..-xx-8-.. version and I12, I13 for the AC NEED..-xx-16-.. version.

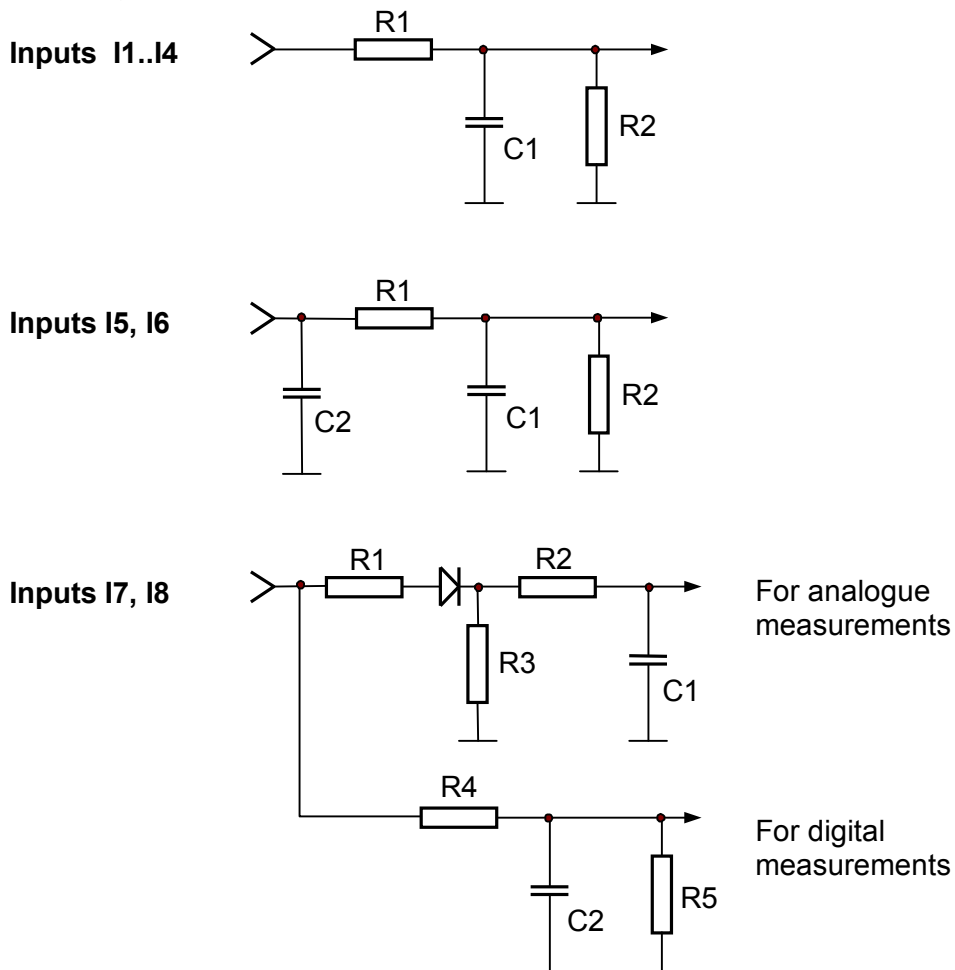

Fig.8.2.1. Schematic diagram of the NEED-230AC-x1-8-4 input circuits.



Inputs with increased resistance to interference include a condenser (anti-interference filter) which allows them to be connected with long cables. Inputs I7, I8 function as digital and analog inputs – see chapter “4.11. Comparator – Analog input.”



The NEED relay inputs are not galvanically separated from the power grid supply.

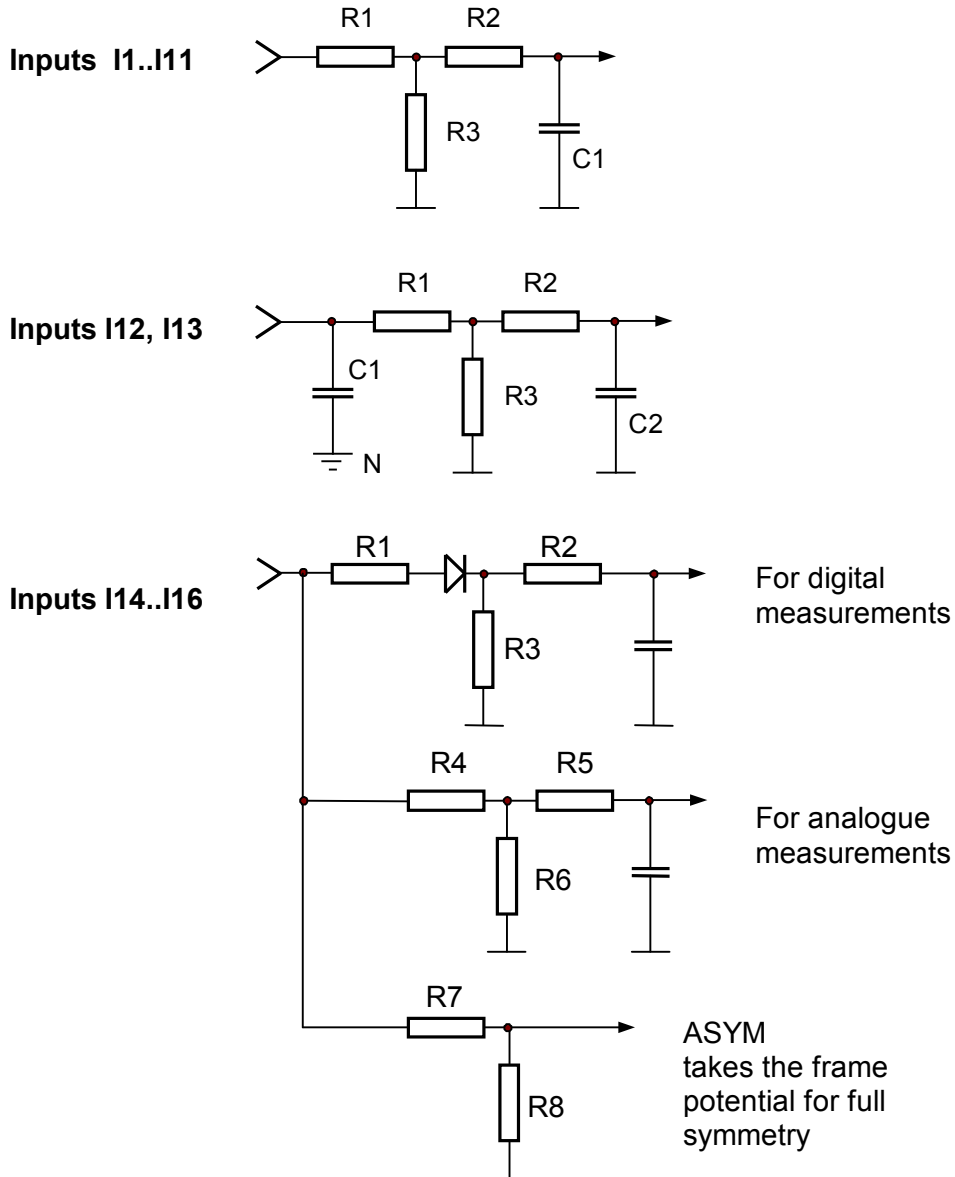

Fig.8.2.2. Schematic diagram of the NEED-230AC-x1-16-8 input circuits.



Inputs with higher noise immunity (I12, I13) are equipped with a capacitor (noise filter), therefore long leads can be connected to them. The I14, I15, I16 have the function of digital inputs and analog inputs – see section 4.11. Comparator - analog input.



The NEED relay inputs are not electrically isolated from the mains power supply.

8.2.2. 220 V DC inputs

Concept diagram of the NEED relay input systems is shown in Fig. 8.2.3 and Fig. 8.2.4
 Analog inputs are I7 and I8 for the DC NEED..-xx-8-.. version and I14, I15, I16 for the
 NEED..-xx-16-.. version.

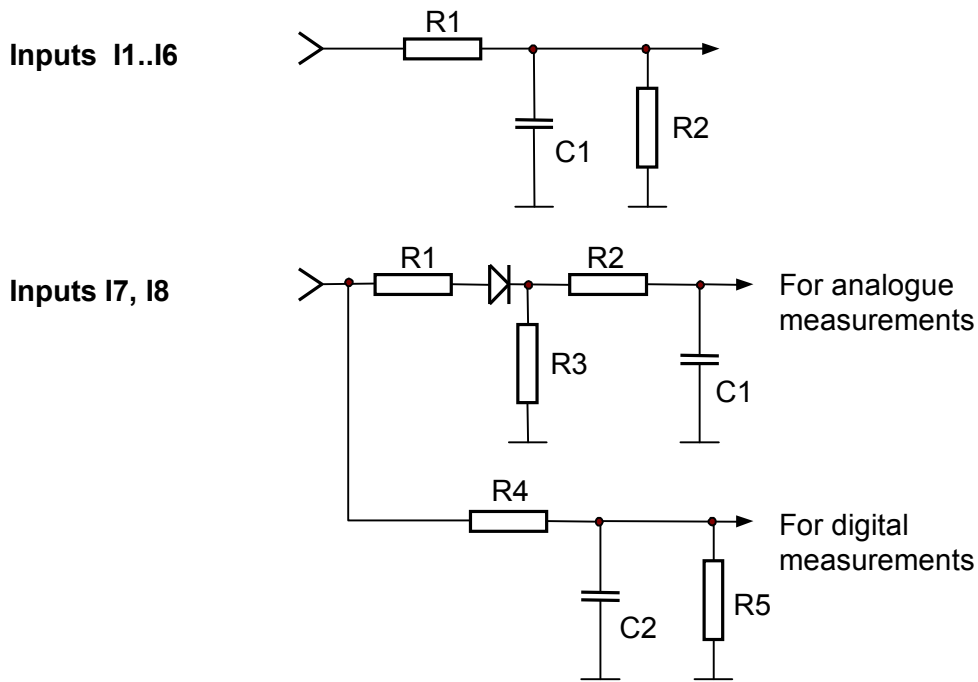

Fig.8.2.3. Schematic diagram of the NEED-220DC-x1-8-4 input circuits.

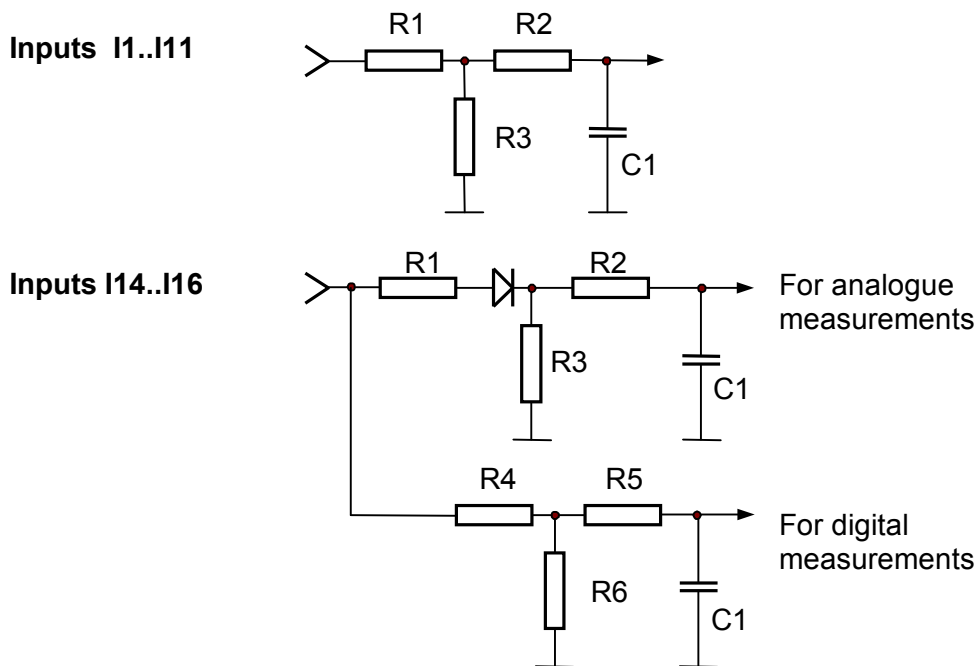

Fig.8.2.4. Schematic diagram of the NEED-220DC-x1-16-8 input circuits.



The NEED relay inputs are not galvanically separated from the power grid supply.

8.2.3. 24 (12) V DC inputs

The schematic diagram of the NEED DC relay input circuits was presented in fig. 8.2.5. All digital and digital-analog inputs for NEED-..DC-xx-8-4 have a similar arrangement of connections. The analog-digital inputs have a different connection layout for the NEED-..DC-xx-16-8 version, as shown in fig. 8.2.6.

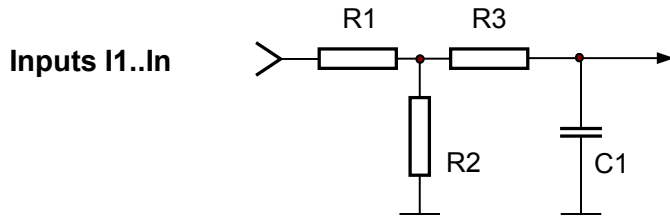

Fig.8.2.5. Schematic diagram of the NEED-24DC-x1-8-4 relay input circuits.

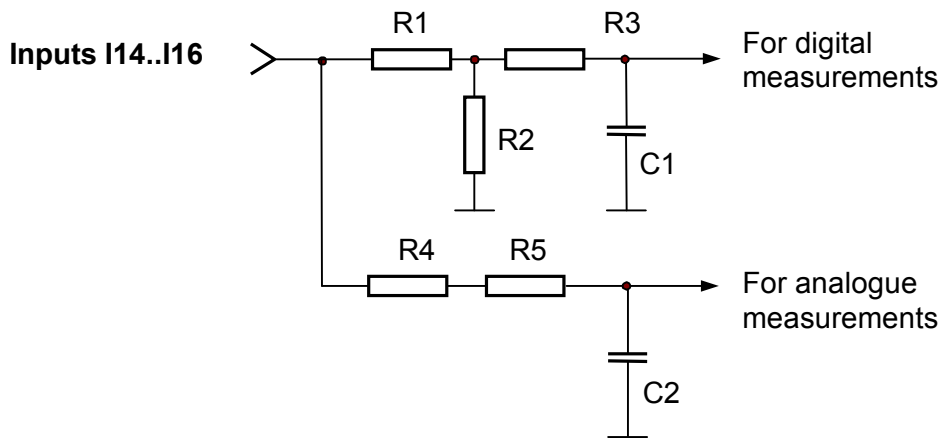

Fig. 8.2.6. Schematic diagram of the NEED-24DC-x1-16-8 digital-analog inputs.

8.3. Outputs

Schematic diagram of the NEED relay output circuits is presented in Fig.8.3.1 – 8.3.3.

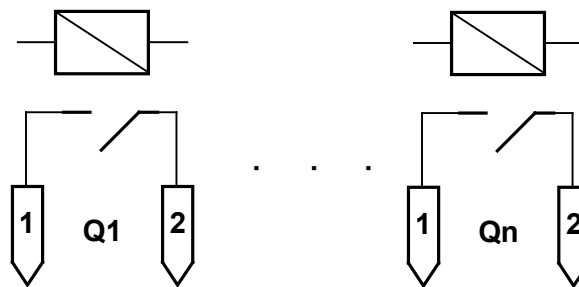

Fig.8.3.1. Schematic diagram of the NEED relay output circuits.

NEED relay outputs are potential-free relay contacts.

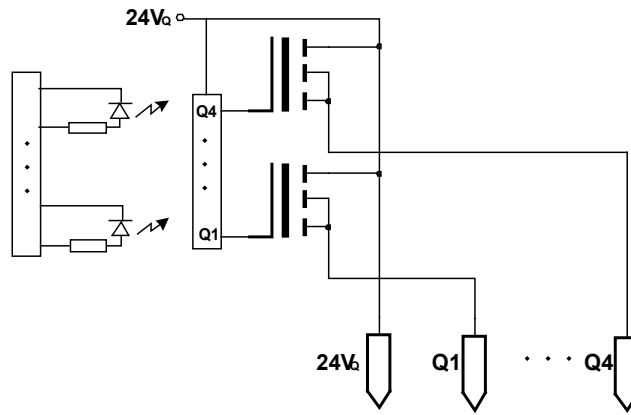

Fig.8.3.2. Schematic diagram of the NEED transistor output circuits – NEED-24DC...-08-4T

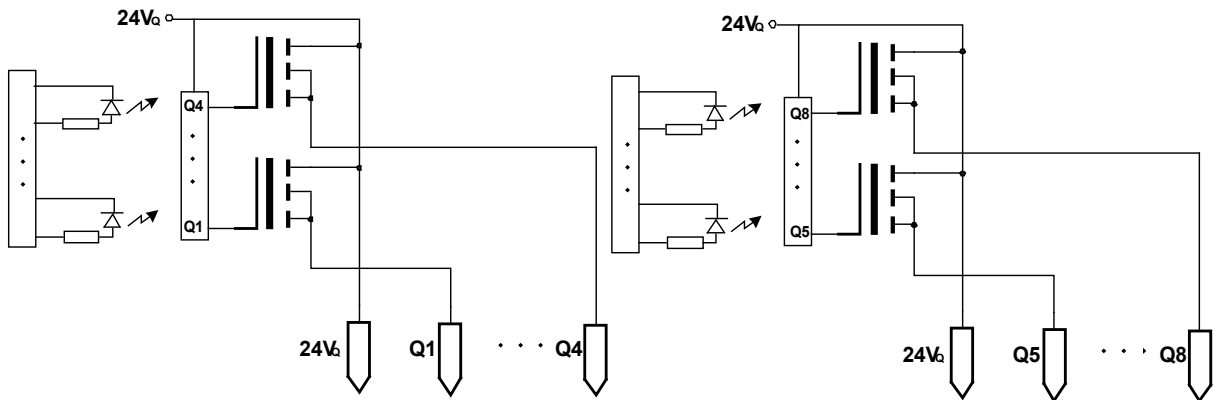

Fig.8.3.3. Schematic diagram of the NEED transistor output circuits – NEED-24DC...-16-8T



NEED relay outputs are electrically separated from the inputs and the mains power supply.

8.4. Input delay

A frequent problem in control issues is contact bounce e.g. relay contact bounce. The NEED programmable relay enables appropriate setting of input delays so that those problems can be eliminated. Input signal processing in the NEED relay is illustrated in Fig.8.4.1.



Fig.8.4.1. Processing of input signals in the NEED relay

Input delays in the NEED relay can be adjusted using program configuration (see chapter 6: „INSTALLATION AND SOFTWARE DESCRIPTION“). A sample configuration window of PC Need program including a delay for the I2 input is presented in Fig. 8.4.2.



Fig. 8.4.2. Sample input delay configuration.

8.4.1. Input delays for NEED-230AC-... relay

If no delay is set for the inputs then the NEED relay checks input signals every 20ms (one positive half of the sinusoidal waveform for the power supply frequency of 50 Hz). Directly after the check it will perform interpretation of whether the voltage present at the input is at high or a low state. It means that the maximum input signal interpretation time (without delay) is 20ms + program cycle time.

After that time, at the maximum, the signal present at the NEED non-delayed input can be „noticed“ and properly interpreted by the relay.

If a delay is preset for the inputs then the NEED relay performs interpretation of input signals every 20ms (at the supply voltage frequency of 50Hz). If the input state remains unchanged after the third check the relay will perform interpretation to recognize the voltage level as low or high. It means that the maximum input signal interpretation time is 60ms + program cycle time.

After the maximum time of 60ms (but not before 40ms), the signal present at the NEED input can be „noticed“ and properly interpreted by the relay.

Table 8.1. presents delay times for the programmable relay inputs.

Table 8.1. Delay times of the NEED relay inputs.

Supply voltage frequency	Input signal maximum delay time	
	Delay ON	Delay OFF
f=50Hz	60ms+cycle time	20ms+ cycle time
f=60Hz	49.8 ms+ cycle time	16,6ms+ cycle time

Interpretations of logical states of the NEED relay inputs are presented in Fig. 8.4.3. and Fig. 8.4.4.

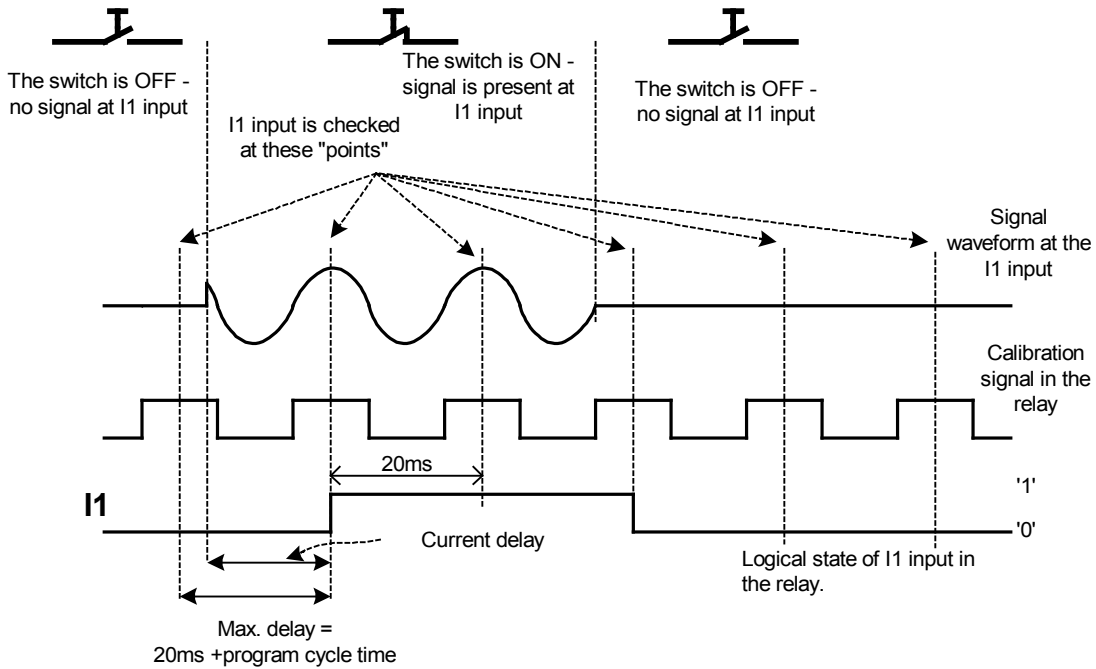

Fig. 8.4.3. Interpretation of the relay I1 input logical; state – delay time not preset – NEED-230 AC.

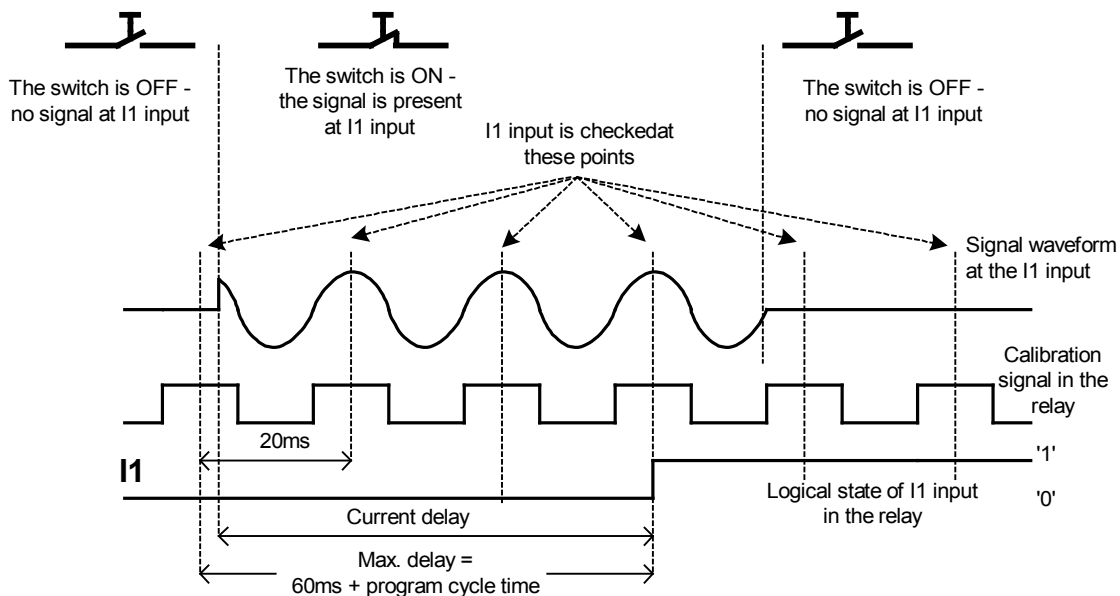

Fig. 8.4.4. Interpretation of the relay I1 input logical state – delay time preset – NEED-230AC-...

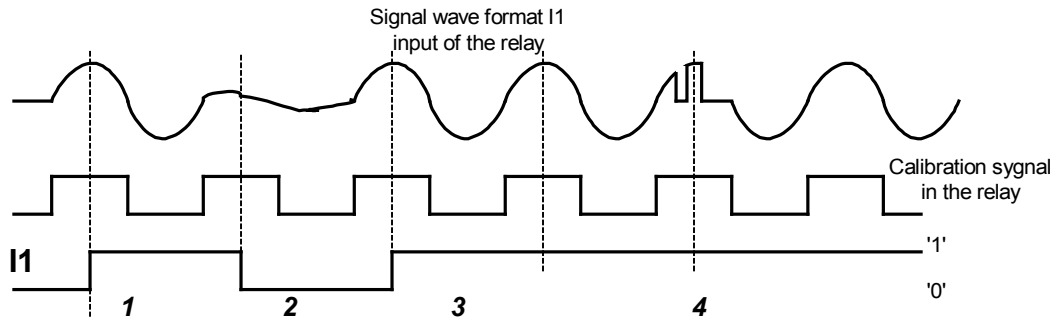

Fig.8.4.5. Sample interpretation of the relay I1 input logical state – delay time not preset – NEED-230AC-...

The following stages can be distinguished in the input signal waveform illustrated in Fig. 8.4.5.:

Input signal is at high state (1) so the relay interprets it as a logical one. However, if within the following 20ms the relay does not detect the right sinusoid level then it changes the state of its input to logical zero (2). After further 20ms the input signal is interpreted as a high state (3). Short pulses can be detected correctly if they occur at right moments in the input signal interpretation by the relay (4).

8.4.2. Input delays for NEED-24DC-... , NEED-12DC relays

If no delay is set for the inputs then the NEED relay checks input signals once in a loop cycle. Directly after the check it will perform interpretation of whether the voltage present at the input is at a high or a low state. It means that the maximum input signal interpretation time (without delay) is equal to the maximum program cycle time

After that time, at the maximum, the signal present at the non-delayed input can be „noticed” and properly interpreted by the relay.

If a delay is preset for the inputs then the NEED relay performs interpretation of input signals every 21ms. It means that the maximum delayed input signal interpretation time is 21ms + program cycle time.

After the maximum time of 21ms, the signal present at the NEED input can be „noticed” and properly interpreted by the relay.



If during the delay time measurement in NEED-24DC-..., NEED-12DC-... relays, the input signal is changed the time count is restarted.

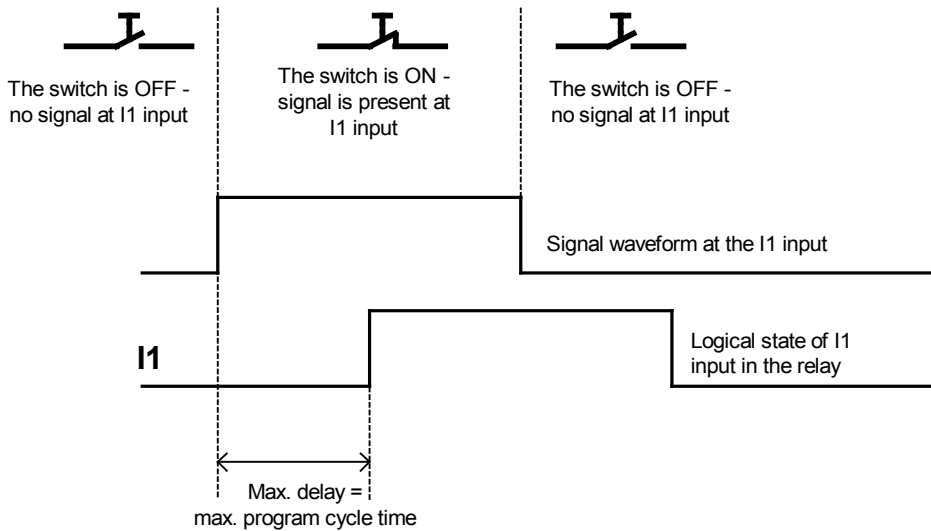

Fig.8.4.6. Sample interpretation of the relay I1 input logical state – delay time not preset – NEED-24DC-..., NEED-12DC-...

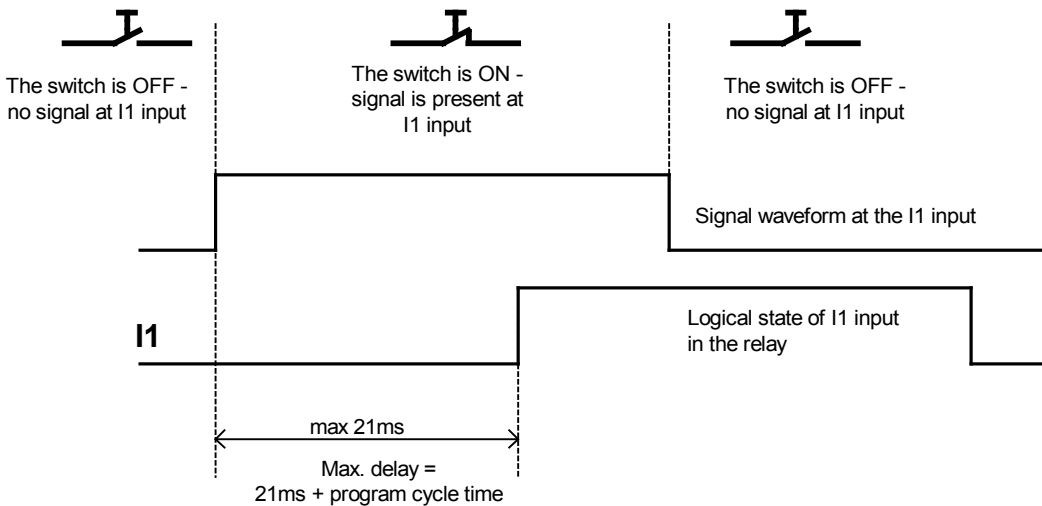

Fig.8.4.7. Sample interpretation of the relay I1 input logical state – preset delay time – NEED-24DC-..., NEED-12DC-...

8.5. Output delay.

Outputs of the NEED relay are not delayed – they are set as quickly as possible. However, one must take into account the delays resulting from the output control elements used e.g. for the version NEED-230AC-01-08-4R the operating time is:

Output relay operating time + cycle time.

9. EXTERNAL MEMORY

9.1. Memory card

In order to enhance the functionality of the NEED relay an external memory card NEED is available. These are 1 kB and 4 kB EEPROM modules, correspondingly.

The memory can be used for copying the program to the NEED relay without the need to use a computer.

The NEED-M-1K (1 kB) memory is used only in the relay versions NEED ..-01-... and NEED ..-11-... It is available in 2 versions with different interface type – older A and newer B.

The NEED-M-4K (4 kB) memory is used only in the relay version NEED ..-22-... (version **22** e.g. NEED 24DC-**22**-16-8 with an LCD display). Only the B version is available.

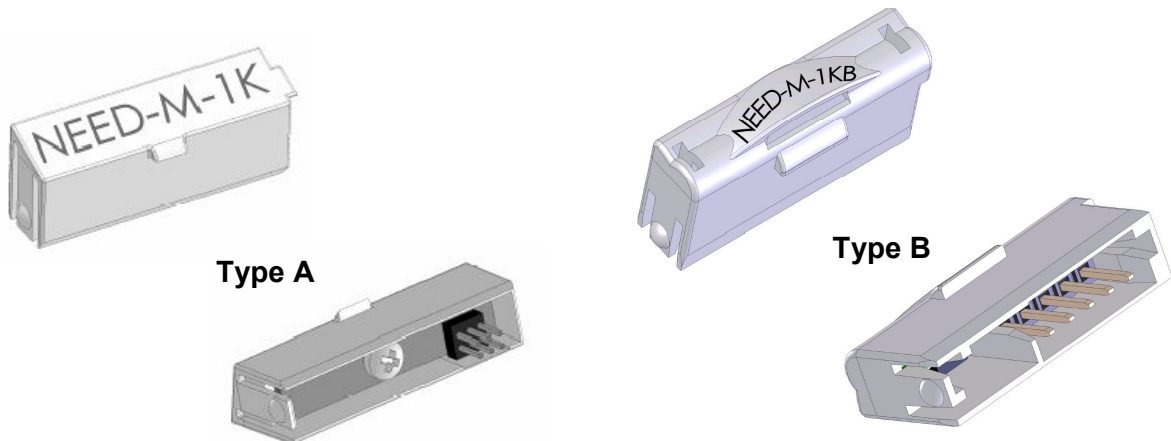

Fig. 9.1.1. External memory module – top and bottom views.

The module is programmable using a cable for programming the NEED relay. To this end place the module in the appropriate terminal, in the programming cable plug (Fig. 9.1.2).

It is also possible to read the settings saved in the memory partition.

Upon removing the programming cable from the plug place the programmed memory card in the relay in place of the programming cable plug – the programming cable and the memory use the same terminal of the NEED relay.

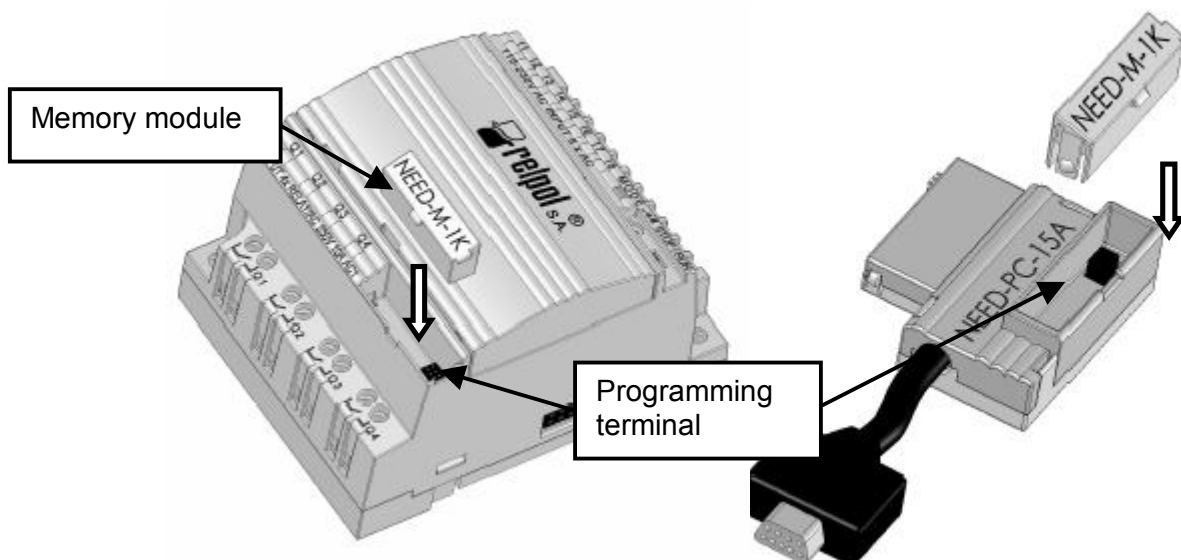

Fig. 9.1.2. External memory module installation place in the relay and the cable terminal.



Note: The lead with inserted memory module should not be connected to the programming port and used for programming the relay.



Note: Using the lead with inserted memory module for programming can result in uncontrolled data transmission to the relay or memory module.

9.2. Storage organization

The card memory is split into 2 partitions – one for code storage and the other for storage of settings. When programming the memory card you can select which partitions are to be active. If a partition is active the data written in it are copied to the NEED relay memory. Therefore it is possible to load a program code only, or to load new settings only or to load both the program code and the settings. If none of the partitions is active the relay will load no data to its internal memory.

9.3. Memory programming

9.3.1. Writing a program

If a memory card is connected to the programming cable terminal, enable that program window the code of which is to be written to the memory (active window is the one in the foreground, with blue title bar). Then go to **Relay > External memory > Write**.

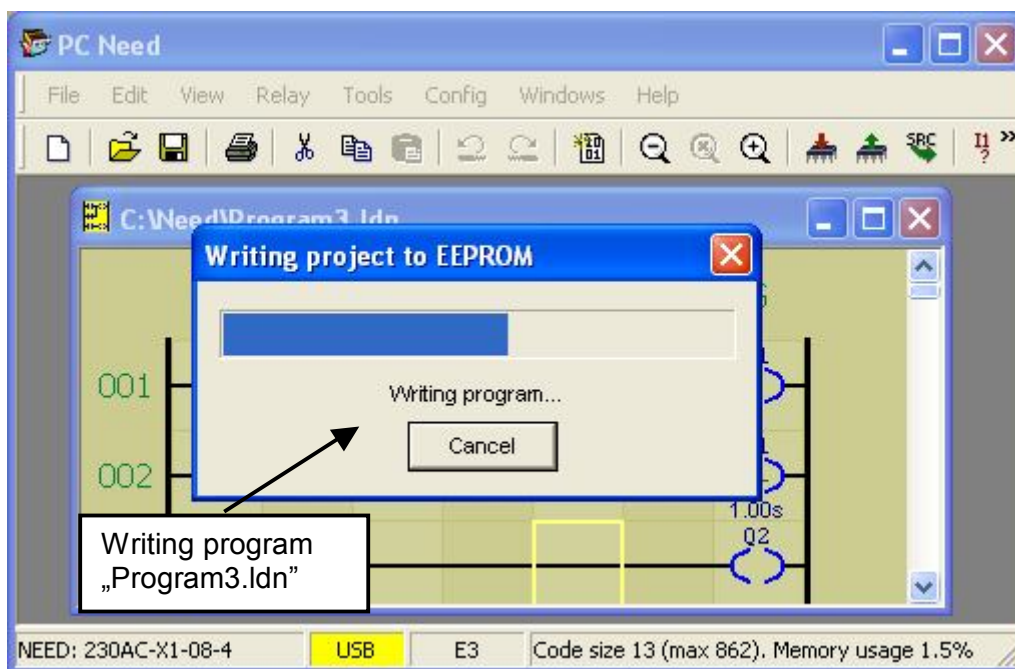

Fig. 9.3.1.1. Writing a program.

Upon opening the “*Writing a program*” window set the password according to that set in the relay and press *Start* button. The password prompt appears only if the option “Don’t ask for the password” was not set in program configuration.



Note: If the password entered during memory programming is different than the password in the NEED relay the program is not copied to the internal memory of the programmable relay.

Once the operation is performed a message is displayed to inform that the program writing is completed. Press OK – the program code is placed in the card memory.

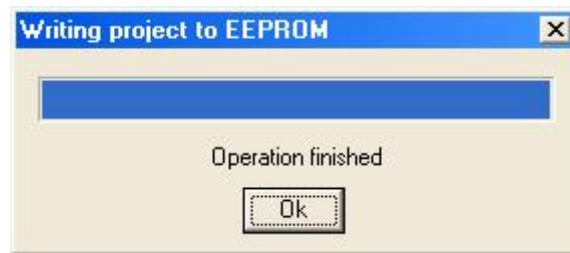

Fig. 9.3.1.2. „Writing program” window.

9.3.2. Writing settings

If a memory card is connected to the programming cable terminal, enable (in the foreground, with blue title bar) the *Settings* window. Then go to **Relay > External memory > Write**

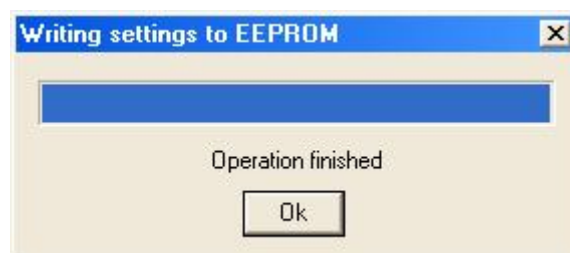

Fig. 9.3.2.1. “Writing settings” window.

Upon opening the *Writing relay settings* window decide whether the settings are to be protected with a password and press *Start* button. The password must be according to that written in the relay. Otherwise the memory will not be copied. Once the writing is finished a message is displayed to inform that the writing of settings is completed.

9.3.3. EEPROM memory status

To retrieve the memory status control option: **Relay > External memory > Status.**

You can disable – with the *Disable* button the *Program* or *Settings* partition or both.

Once e.g. the *Program* partition has been disabled (Fig. 9.3.3.2) only the data from the *Settings* partition will be copied to the NEED relay.

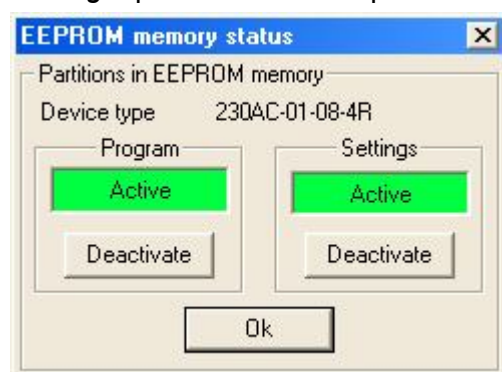

Fig. 9.3.3.1. „Active partitions” window.

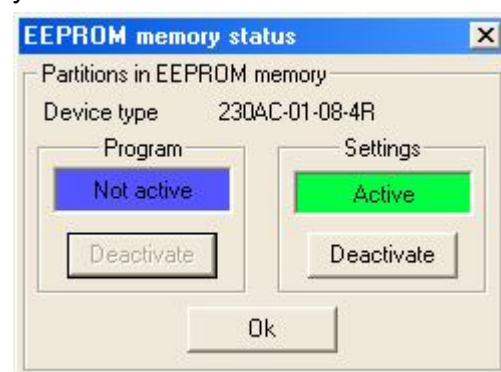

Fig. 9.3.3.2. „Inactive partitions” window.



Note: Partition is enabled (activated) by loading a new content.

9.3.4. Reading the settings

It is possible to read the *Settings* partition from the memory card.

To this end, in the workspace of PC Need enable the Settings window where the read data are to be sent. In the example below a *Read_EEPROM.set* file was created for that purpose. After execution of the command of **Relay > External memory > Read** (see window below) – the data will be copied from the partition to the file with *.set* extension.

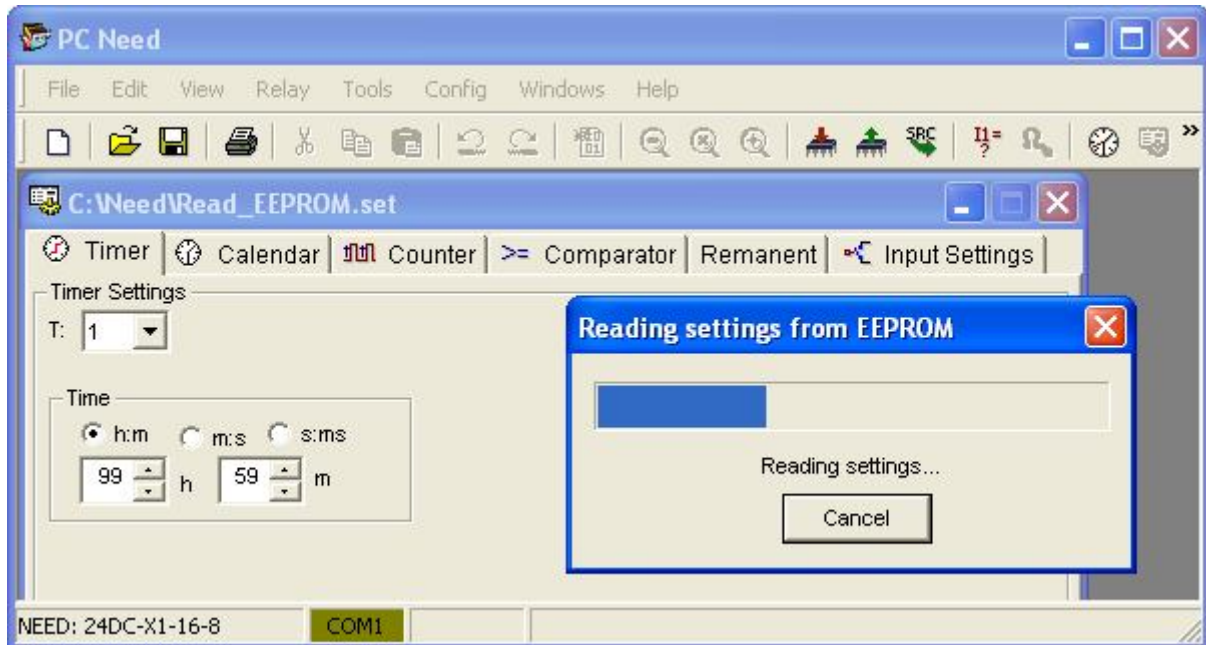

Fig. 9.3.4.1. "Reading settings" window.

9.4. Operation of memory card with NEED relay



Memory card can be inserted only while the power supply of the NEED relay is off.



Voltages hazardous to health and life can be present at the communication port (applies to 115/230V AC version).



Inserting a card while the relay power supply is on may result in a damage to the memory circuit and the relay.

1. While the power is off insert the memory card module in the programming terminal of the NEED relay.
2. Once the module power is switched on the memory contents (active partitions) is copied to the NEED relay memory. A red MODE LED is blinking during the copying operation.
3. Once the contents is copied the relay sets the operating mode according to the position of the operating mode switch. If RUN mode is selected program execution is started automatically.



Note: Memory contents is copied once on switching the power on. Once the copying is completed the memory module can be removed from the relay terminal.



Note: Rewriting data from memory to the controller is possible when:

- the password is correct,
- the memory stores data which are correct for the relay type,
- partitions are active,
- data in the relay are different from those in memory.



Note: External memory does not permit transmitting of the LAD/STL source code to the relay.

10. LCD DISPLAY AND KEYBOARD

10.1. Overview

The NEED-..22-16-8-D relays have a built-in LCD display with a keyboard (Fig. 10.1.1), while the NEED-..22-08-4 relay can be connected to an external LCD panel with a keyboard (Fig. 10.1.2).

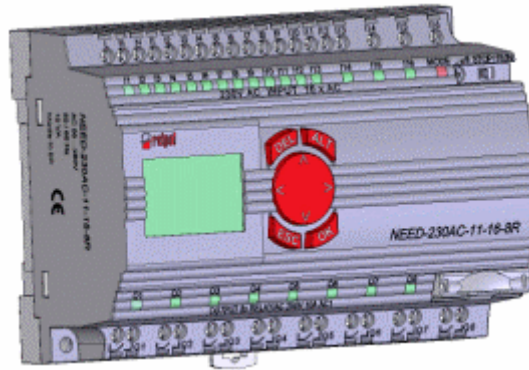

Fig.10.1.1. NEED-..22-16-8-D with built-in keyboard.

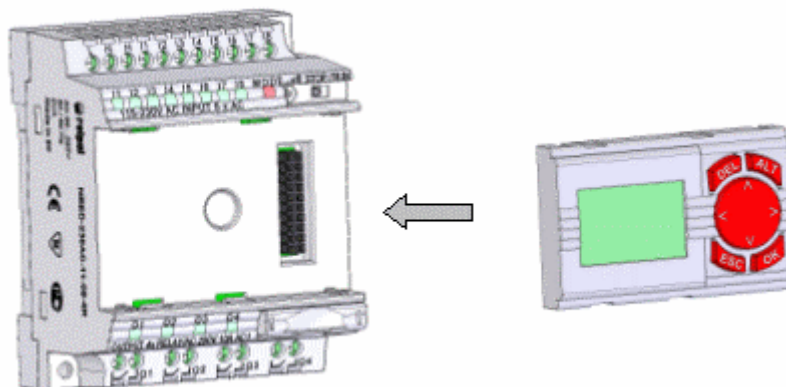

Fig.10.1.2. NEED-..22-08-4-D with attached keyboard.

The display shows up to 4 lines of 12 characters. The keyboard consists of 8 keys. A 4x12-character text display and a keyboard.

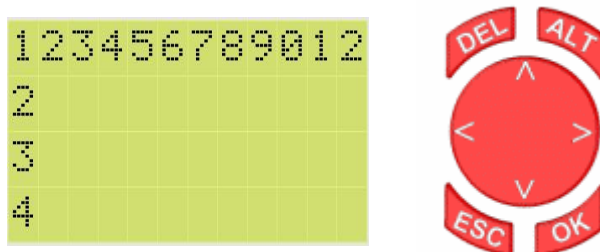









Fig.10.1.3. Text display 4x12 characters and keyboard.

Table 10.1.1. Key functions

<p>Left arrow</p> 	<p>Moves the cursor left by one character or returns to the previous edit field.</p>
<p>Right arrow</p> 	<p>Moves the cursor right by one character or jumps to the next edit field.</p>
<p>Up arrow</p> 	<ol style="list-style-type: none"> 1. Moves the cursor up. 2. Increases the value of a given digit (e.g. time threshold values of Timers and Counters). 3. Changes resource type or parameter (e.g. Counter to Timer or Clock, changes Clock channel or comparison type, etc.). 4. Changes binary value to the other one (state of Outputs and Markers).
<p>Down arrow</p> 	<ol style="list-style-type: none"> 1. Moves the cursor down. 2. Decreases the value of a given digit (e.g. time threshold values of Timers and Counters). 3. Changes resource type or parameter (e.g. Counter to Timer or Clock, changes Clock channel or comparison type, etc.). 4. Changes binary value to the other one (state of Outputs and Markers).
<p>OK key</p> 	<ol style="list-style-type: none"> 1. Open the next menu level of a given parameter. 2. Confirms and saves changes made to a given parameter value.
<p>ESC key</p> 	<ol style="list-style-type: none"> 1. Exits the menu of a given parameter (restores the menu level active before OK was pressed). 2. Cancels changes made to a given parameter. 3. Returns to the alert screen.
<p>DEL key</p> 	<p>Not used</p>
<p>ALT key</p> 	<p>Browses active or unconfirmed alerts.</p>

10.2. Main menu

Once powered-on, the display shows date, time and relay operating mode (RUN, STOP).

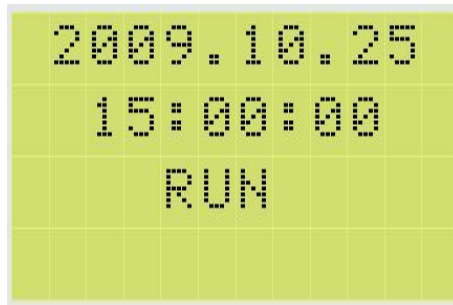

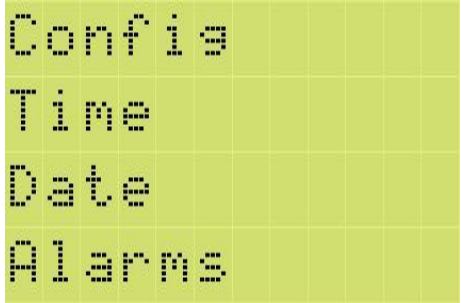
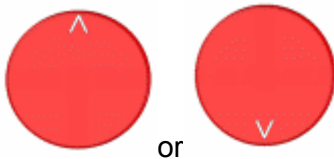
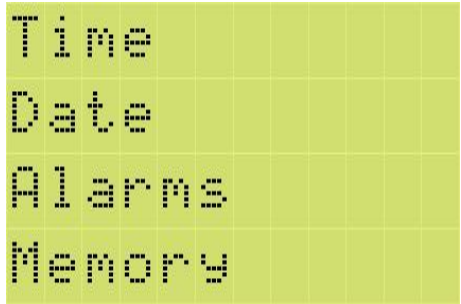

Note: If the relay operates in the RUN mode (operating mode radio button set to RUN) and an alert is triggered (active MTx), the main screen will be replaced with the alert screen.



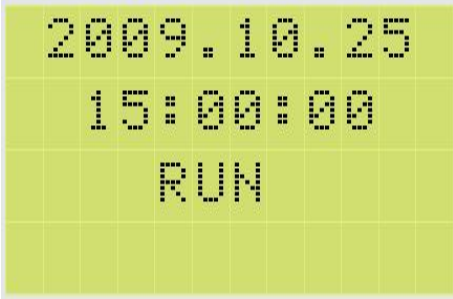

<p>Press OK to open the configuration menu.</p>  <p>(press OK)</p>	
<p>Use up/down arrow to navigate the menu.</p>  <p>or</p>	

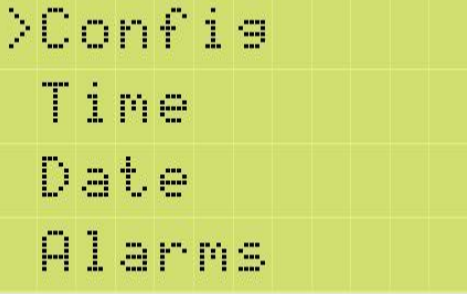
10.3. Configuration menu

Allows you to change program settings and manage the relay. Menu options: Settings, System, Password, Version.

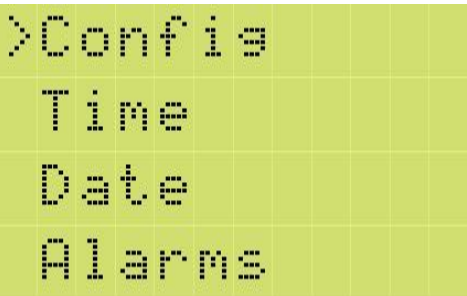
	<p>Screen active after power-on (operating mode radio button set to RUN).</p> 
	<p>Available choices:</p> <ul style="list-style-type: none"> • Configuration • Time • Date • Alerts • Memory

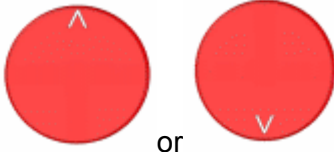

10.3.1. Settings Menu

<pre>>Timers Calendar Counters Comparators</pre>	<p>Use arrows to select resources whose settings you want to change:</p>  <p>or</p> <p>Available resources:</p> <ul style="list-style-type: none"> > Timers Calendar Counters Comparators Markers Inputs Outputs Buttons Fast Counter
-----------------------------------------------------	-------------------------------------------------------------------------------------------------------------------------------------------------------------------------------------------------------------------------------------------------------------------------------------------------------------------------------------------------------------------------------------------------------------------





10.3.1.1. Timers menu

1. Opening the Timer configuration screen.

<pre>>Settings System Password Version</pre>	
<pre>>Timers Calendar Counters Comparators</pre>	
<pre>T01:0 @:SL Rem:0 #:99h59m \$:00h00m</pre>	<p>T – Timer 01 – Timer number (01 – 32) : 0 – State of the output Timer: 1 – Timer on 0 – Timer off @ - Timer configuration (SE, SD, SL, SF) Rem: – Remanence (only for T5 – T8) 0 – Remanence on 1 – Remanence off # - Time for measure (max. 99h59min) \$ - Current time</p>

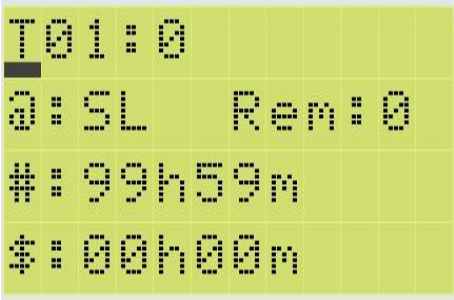
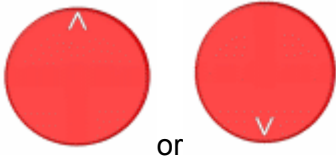
2. Opening other resources.

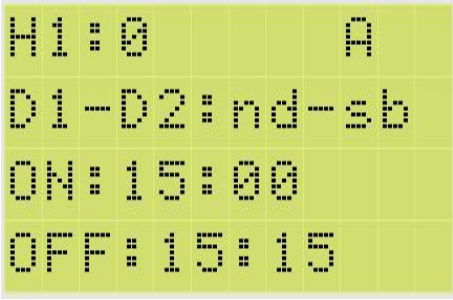
To change resources (e.g. open the screens for Counters, Clocks, etc.), move the cursor to the first display field (letter T).

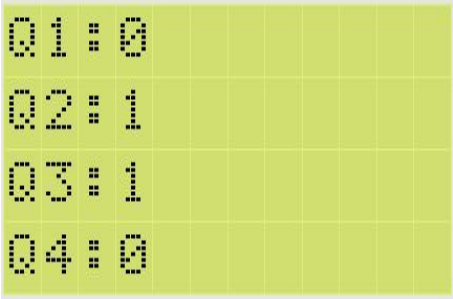



	<p>Use up/down arrow to select the resource type (initial letter of resource name).</p> 
<p>Press down arrow once to open the H – Clocks resources.</p> 	
<p>Press down arrow once to open the Q – Output resources.</p> 	

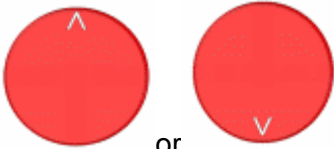

3. Changing the Timer number.

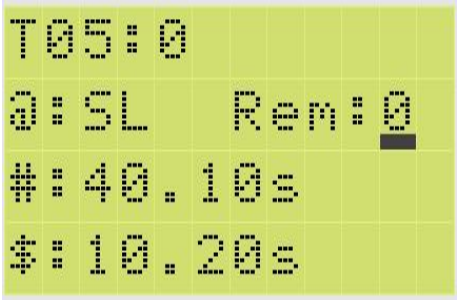
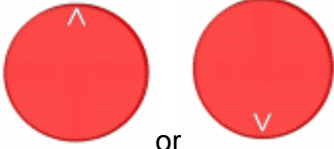
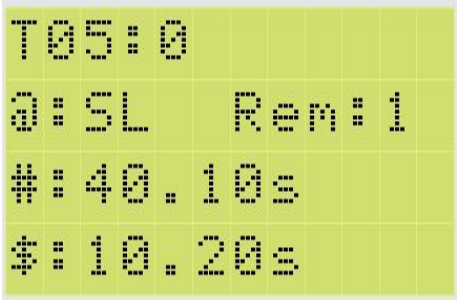
<p>To change the Timer number (e.g. from T1 to T5):</p>	<p>Move the cursor to the field shown here (press right arrow)</p> 
---------------------------------------------------------	----------------------------------------------------------------------------------------------------------------------------------------------------------



	<p>Use up/down arrow to set the Timer number.</p> 
-----------------------------------------------------------------------------------	--------------------------------------------------------------------------------------------------------------------------------------

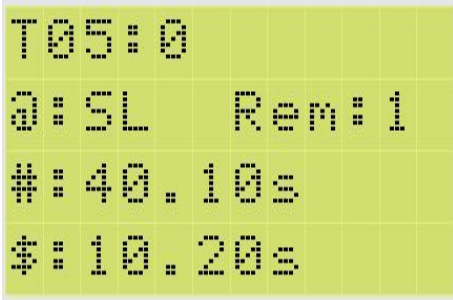
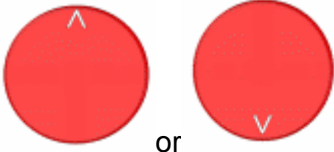
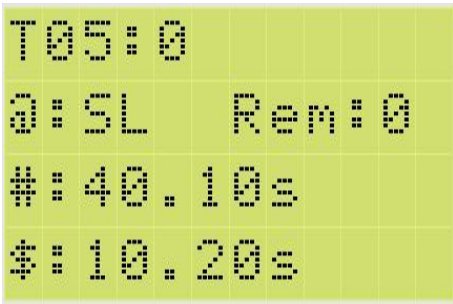

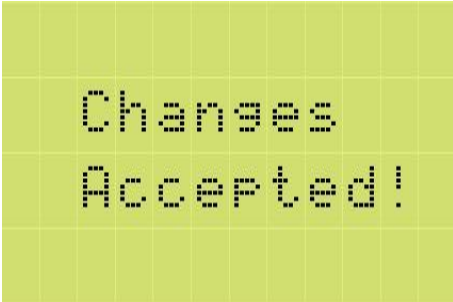
4. Enabling/disabling remanence

<p>Move the cursor to the field shown here (keep pressing right arrow until the cursor will be in the appropriate field).</p>	
	<p>Remanence on Press</p>  <p>Use up/down arrow</p>
	<p>If remanence for Timer T5 was disabled (Rem:0 parameter), it will now be enabled. Confirm changes.</p> 
	



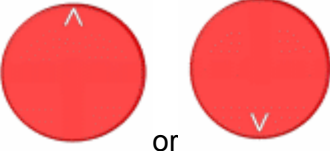
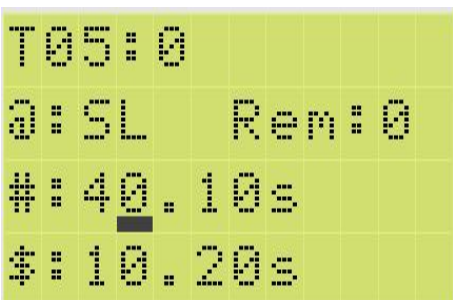

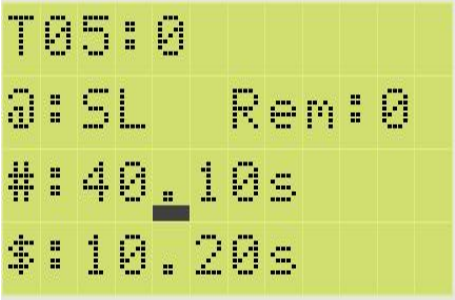

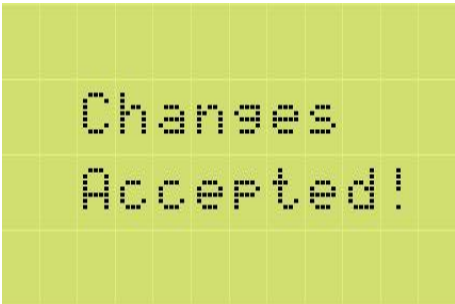
	<p>Remanence off Press</p>  <p>Use up/down arrow</p>
	<p>If remanence for Timer T5 was enabled (Rem:1 parameter), it will now be disabled. Confirm changes.</p> 
	

5. Setting time for countdown.

<p>Move the cursor to the field shown here (keep pressing right arrow until the cursor will be in the appropriate field).</p> 	
<p>Keep pressing up/down arrow until it appears demand worth of time</p> 	

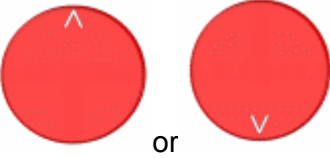
<p>Keep pressing right arrow until the cursor will be in the appropriate field. Set time in the same way as above.</p> 	
<p>Setting time for Timer "T5" T5: 40s100ms</p> <p>Press OK to accept changes</p> 	

6. Changing time range for countdown.

<p>Move the cursor to the field shown here (keep pressing right arrow until the cursor will be in the appropriate field).</p> 	
<p>Keep pressing up/down arrow to set appropriate range of time (s - seconds, m - minutes, h - hours)</p> 	
<p>Setting time for T10: 20m20s</p> <p>Press OK to accept changes</p> 	

10.3.1.2. Calendar menu

1. Open the Calendar configuration screen.

<pre> Timers >Calendar Counters Comparators </pre>	
<pre> H1:0 A D1-D2:su-sa ON:15:00 OFF:15:15 </pre>	<p>H – Clock 1 – Clock number (1 – 8) :0 – State of Clock output: 0 – Clock on 1 – Clock off A - Channel (A, B, C, D) D1-D2: – Days of week: su - Sunday mo – Monday tu – Tuesday we – Wednesday th – Thursday fr – Friday sa - Saturday ON: – Time of turning on the clock output OFF: – Time of turning off the clock output</p>

2. Opening other resources.



To open other resources, follow the same instructions as described for the Timer.

3. Changing the Clock number.

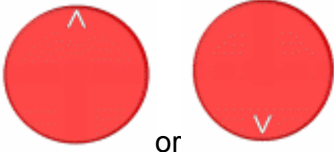
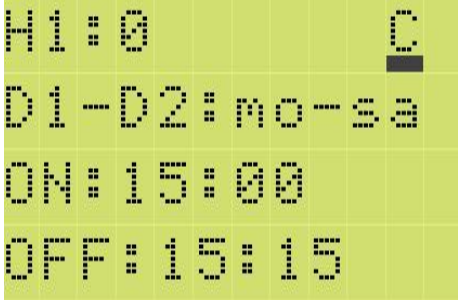

To change the Clock number (e.g. from H1 to H4), follow the same instructions as described for the Timer.

4. Changing the Clock channel.

<p>To change the Clock channel (e.g. A ->B), move the cursor to the field shown here (keep pressing right arrow until the cursor will be in the appropriate field).</p> 	<pre> H1:0 A D1-D2:mo-sa ON:15:00 OFF:15:15 </pre>
----------------------------------------------------------------------------------------------------------------------------------------------------------------------------------------------------------------------------------------------------------------	-----------------------------------------------------------------

<p>Press up/down arrow to choose the demand channel (e.g. C)</p>  <p>or</p>	
<p>Press OK to accept changes</p> 	

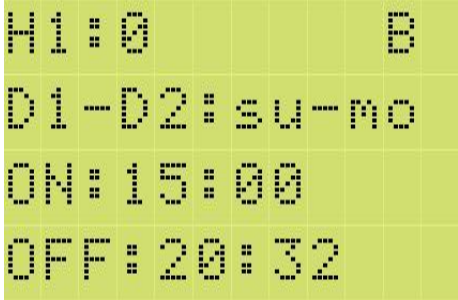
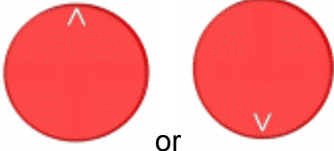
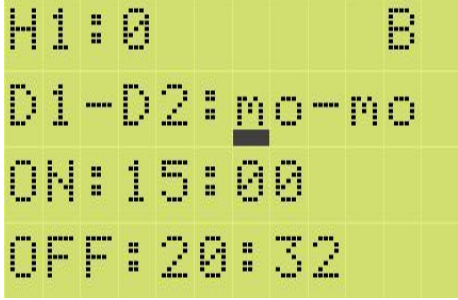
5. Setting the power-on/power-off days for the Clock (D1 – D2).

<p>To select the power-on/power-off days for the Clock output (e.g. Monday to Friday: “mo-fr”): Move the cursor to the field shown here (keep pressing right arrow until the cursor will be in the appropriate field)</p> 	
<p>Press up/down arrow to choose the desired time value (e.g. „mo” Monday).</p>  <p>or</p>	
<p>Move the cursor to the field shown here (keep pressing right arrow until the cursor will be in the appropriate field). Then choose the appropriate day.</p> 	

Press OK to accept changes.



Changes
Accepted!

6. Setting the power-on time for the Clock (ON).

To set the power-on time for the Clock output, move the cursor to the field shown here (keep pressing right arrow until the cursor is in the appropriate field).



H1:0 B
D1-D2:mo-fr
ON:15:00
OFF:20:32

Press up/down arrow to choose the demand worth of time.

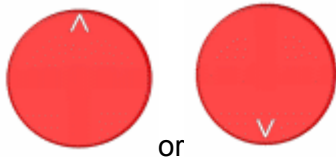

H1:0 B
D1-D2:mo-fr
ON:05:00
OFF:20:32

Move the cursor to the power-on time field (ON) and follow the same instructions to set the remaining time fields.

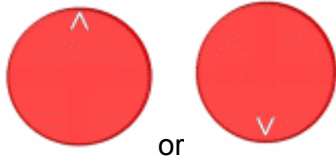

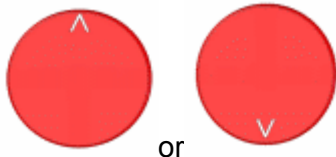

H1:0 B
D1-D2:mo-fr
ON:02:00
OFF:20:32

Press up/down arrow.

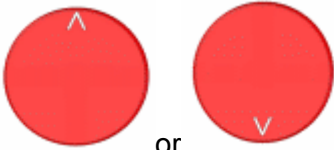
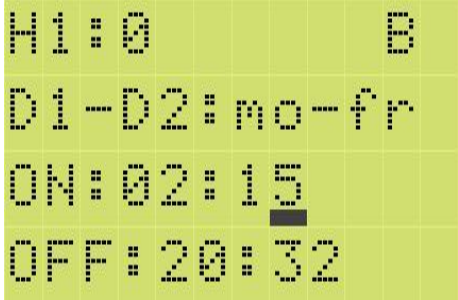

H1:0 B
D1-D2:mo-fr
ON:02:10
OFF:20:32

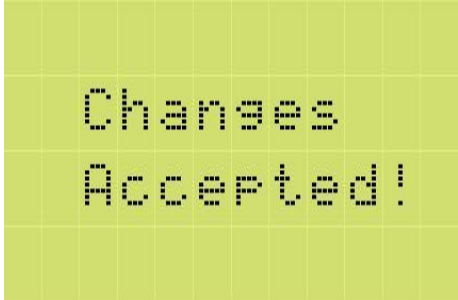

<p>Press up/down arrow.</p>  <p>or</p>	
<p>Power-on time set for the Clock H1, channel B: 02:15.</p>	
<p>Press OK to accept changes.</p> 	

7. Setting the power-off time for the Clock (OFF).

To set the power-off time for the Clock (OFF), follow the same instructions as described for the power-on time.

10.3.1.3. Counters menu

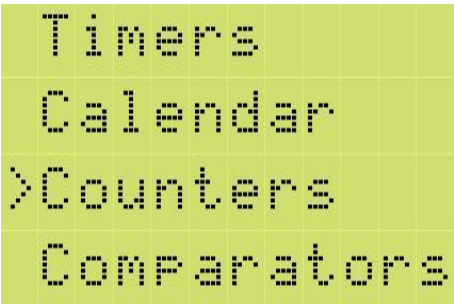
1. Open the Counters configuration screen.

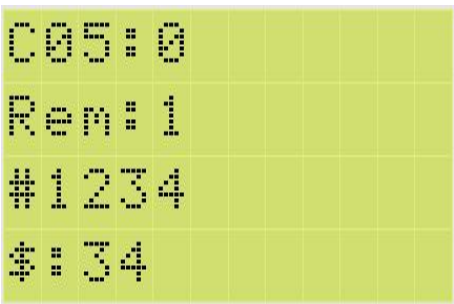
	
	<p>C – Counter 05 – Counter number (1 – 8) :0 – State Counter output: 0 – Counter output off 1 – Counter output on Rem: – Remanence 0 – Remanence on 1 – Remanence off #: – Counter threshold \$: – Current value of Counter</p>





2. Opening other resources.

To open other resources, follow the same instructions as described for the Timer.

3. Changing the Counter number.

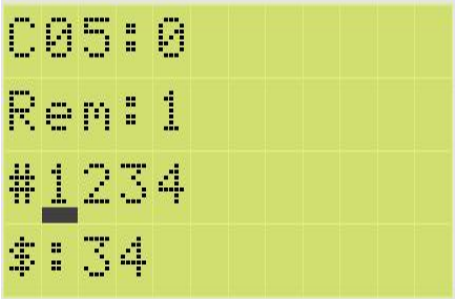
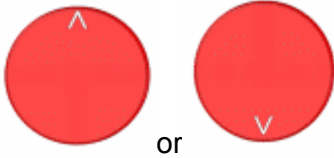
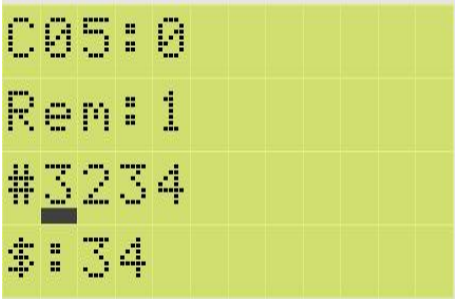

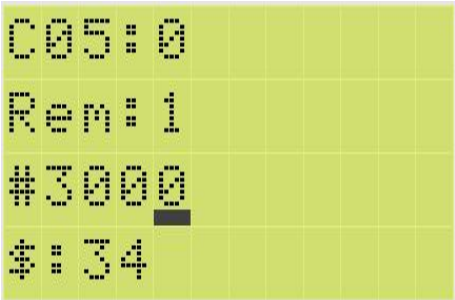
To change the Counter number (e.g. from C5 to C8), follow the same instructions as described for the Timer.

4. Setting the Counter threshold.

<p>Move the cursor to successive fields (keep pressing right arrow until the cursor will be in the appropriate field).</p> 	
<p>Press up/down arrow to set demand Counter threshold</p> 	
<p>Move the cursor to next fields (keep pressing right arrow until the cursor will be in the appropriate field) and set the desired value as described above</p> 	
<p>Set threshold value for C05: 3000</p> <p>Press OK to accept changes</p> 	

10.3.1.4. Comparators menu

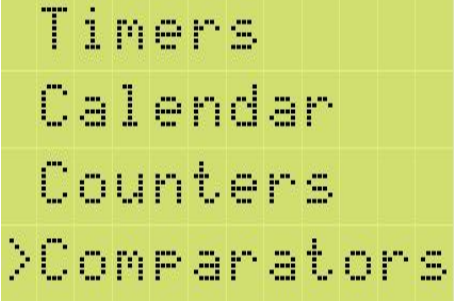
1. Open the Comparator Configuration screen.

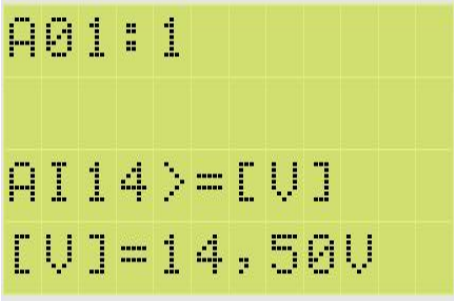
	
	<p>A – Comparator 01 –Comparator number (1 – 16) :0 – State Comparator output: 0 – Comparator output off 1 – Comparator output on AI14>=[V] – Type of comparison [V]=14,50 – Threshold – if the AI14 voltage is greater than or equals 14.50V, the Comparator output state will be set to high.</p>

2. Opening other resources.



To open other resources, follow the same instructions as described for the Timer.

3. Changing the Comparator number.

To change the Comparator number (e.g. from A5 to A1), follow the same instructions as described for the Timer.

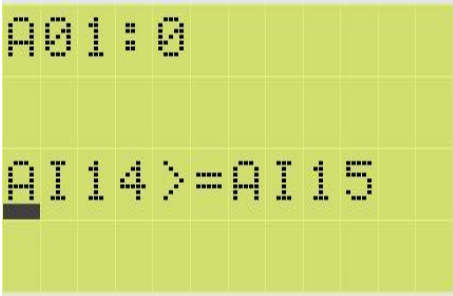
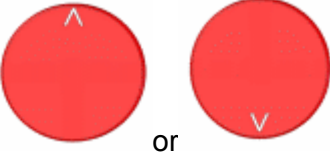
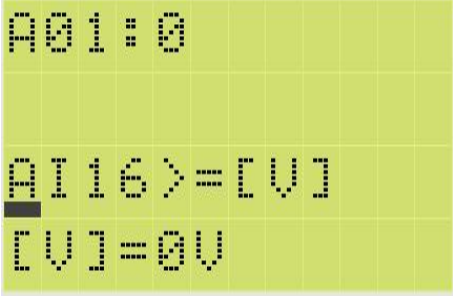

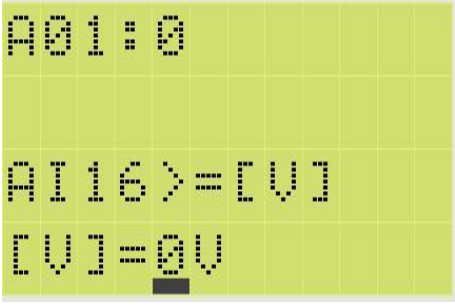
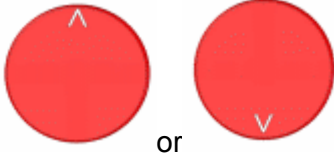
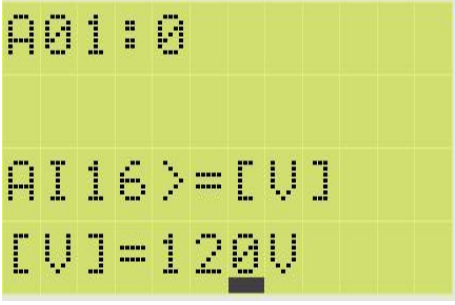
4. Choosing the Comparator relations.

<p>Move the cursor to the field shown here (keep pressing right arrow until the cursor will be in the appropriate field).</p> 	
<p>Press up/down arrow to set demand Comparator relations (see “5. Comparisons available to Comparators”).</p> 	

<p>Move the cursor to next fields (keep pressing right arrow until the cursor is in the appropriate field) and set the desired value as described above</p> 	
<p>Press up/down arrow to set the desired standard value for a given Comparator relation (e.g. 120V)</p> 	
<p>Press OK to accept changes</p> 	

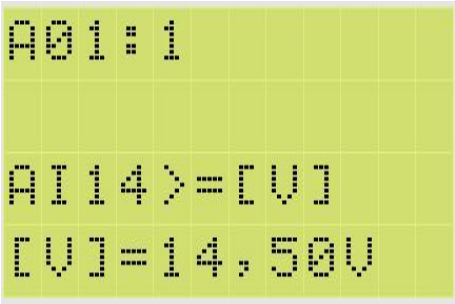
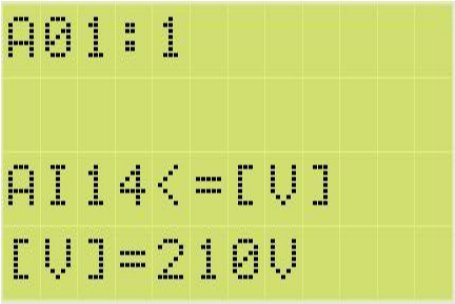

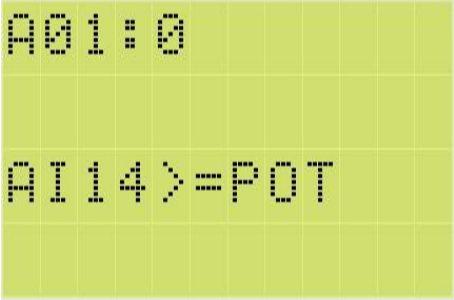
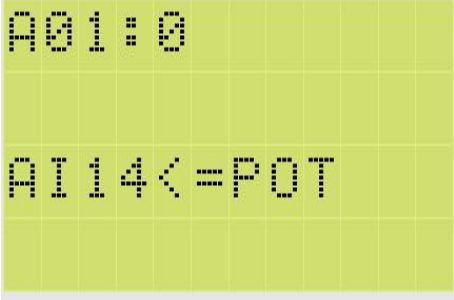
5. Comparisons available to Comparators.

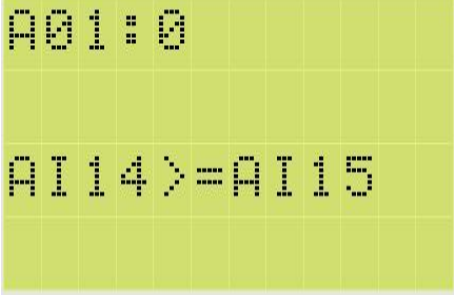
	<p>1. AI14>=[V] (AI15>=[V], AI16>=[V]) e.g. [V]=14.50V</p> <p>If the AI14 (AI15, AI16) voltage is greater than or equals 14.50V, the Comparator output state will be set to high.</p>
	<p>2. AI14<=[V] (AI15<=[V], AI16<=[V]) e.g. [V]=210V</p> <p>If the AI14 (AI15, AI16) voltage is less than or equals 210V, the Comparator output state will be set to high.</p>

	<p>3. AI14 >= POT (AI15 >= POT, AI16 >= POT)</p> <p>If the AI14 (AI15, AI16) voltage is greater than or equals from the standard value set using the in-built Potentiometer, the Comparator output state will be set to high.</p>
	<p>4. AI14 <= POT (AI15 <= POT, AI16 <= POT)</p> <p>If the AI14 (AI15, AI16) voltage is less than or equals from the standard value set using the in-built Potentiometer, the Comparator output state will be set to high.</p>
	<p>5. AI14 <= AI15 (AI14 <= AI16, AI15 <= AI14, AI15 <= AI16, AI16 <= AI14, AI16 <= AI15)</p> <p>If the AI14 (AI15, AI16) voltage is less than or equals AI15 voltage, the Comparator output state will be set to high</p>
	<p>6. AI14 >= AI15 (AI14 >= AI16, AI15 >= AI14, AI15 >= AI16, AI16 >= AI14, AI16 >= AI15)</p> <p>If the AI14 (AI15, AI16) voltage is greater than or equals AI15 voltage, the Comparator output state will be set to high</p>

10.3.1.5. Markers menu.

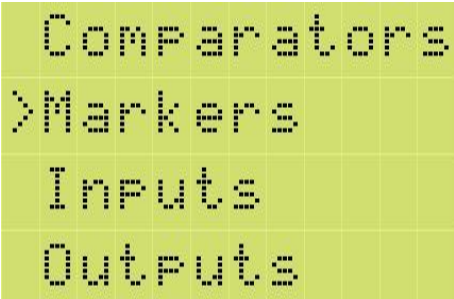
1. Open the Markers Configuration screen.

	
-------------------------------------------------------------------------------------	---------------------------------------------------------------------------------------

<pre>M02: 0 ren: 0 M03: 0 ren: 1 M04: 1 ren: 0 M05: 0 ren: 0</pre>	<p>M – Marker 02 –Marker number (1 – 64) :0 – Marker output state: 0 – Marker output off 1 – Marker output on Rem: – Remanence 0 – Remanence off 1 – Remanence on</p>
--------------------------------------------------------------------------------	------------------------------------------------------------------------------------------------------------------------------------------------------------------------------------------------------------------------------------------------------------------

2. Opening other resources.

To open other resources, follow the same instructions as described for the Timer.

3. Changing the Marker number.

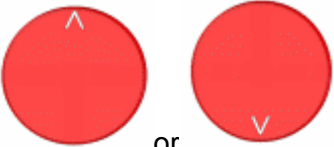

<p>Move the cursor to the field shown here (keep pressing right arrow until the cursor will be in the appropriate field).</p> 	<pre>M02: 0 ren: 0 M03: 1 ren: 0 M04: 0 ren: 0 M05: 1 ren: 1</pre>
<p>Press up/down arrow to reach the next Markers.</p> 	<pre>M02: 0 ren: 0 M03: 1 ren: 0 M04: 0 ren: 0 M05: 1 ren: 1</pre>

4. Enabling/disabling Remanence.

To enabling/disabling remanence for Markers, follow the same instructions as described for the Timer.

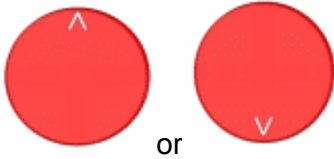
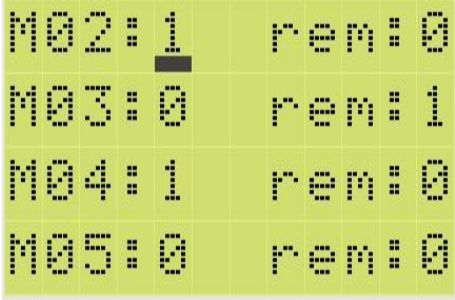

5. Setting Marker output.

<p>Move the cursor to the field shown here (keep pressing right arrow until the cursor will be in the appropriate field).</p> 	<pre>M02: 0 ren: 0 M03: 0 ren: 1 M04: 1 ren: 0 M05: 0 ren: 0</pre>
-------------------------------------------------------------------------------------------------------------------------------------------------------------------------------------------------------------------	--------------------------------------------------------------------------------

<p>Press up/down arrow to SET/RESET Marker output.</p> 	
<p>Press OK to accept changes</p> 	

10.3.1.6. Inputs menu

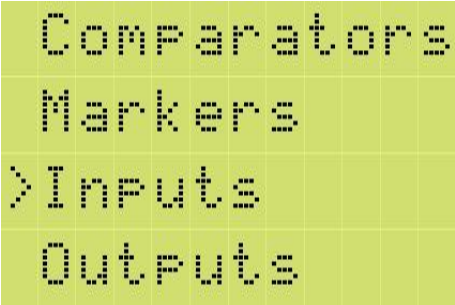
1. Open the Inputs Configuration screen.

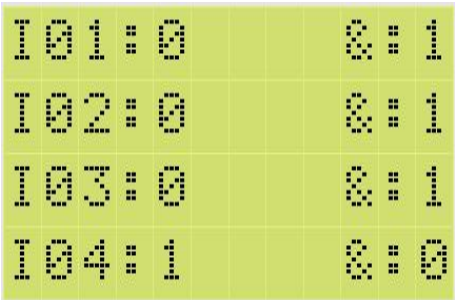
	
	<p>I – Input 01 – Input number (1 – 8 or 1-16) :0 – Input output state: 0 – Low state on the input 1 – High state on the input &: – Input delay 1 – Delay on 0 – Delay off</p>





2. Opening other resources.

To open other resources, follow the same instructions as described for the Timer.

3. Changing the Input number.

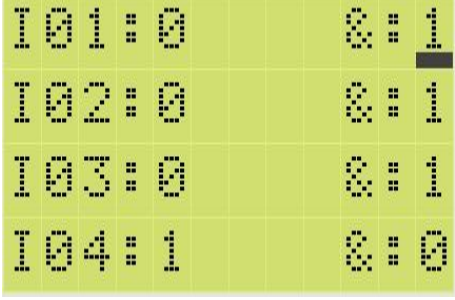

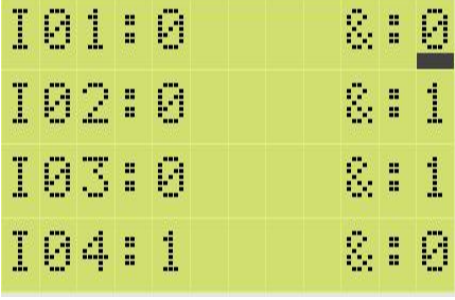
To change the Input number (e.g. from I5 to I8), follow the same instructions as described for the Marker.

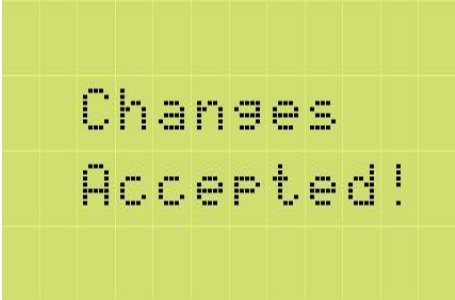
4. Enabling/disabling delay.

<p>Move the cursor to the field shown here (keep pressing right arrow until the cursor will be in the appropriate field).</p> 	 <pre> I01:0 &:1 I02:0 &:1 I03:0 &:1 I04:1 &:0 </pre>
<p>Press up/down arrow to on/off delay on choosing Input.</p>  <p>or</p> 	 <pre> I01:0 &:0 I02:0 &:1 I03:0 &:1 I04:1 &:0 </pre>
<p>Press OK to accept changes.</p> 	 <pre> Changes Accepted! </pre>

10.3.1.7. Outputs menu

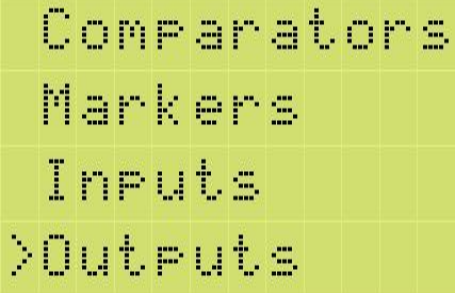
1. Open the Outputs Configuration screen.

 <pre> Comparators Markers Inputs >Outputs </pre>	
-----------------------------------------------------------------------------------------------------------------------------------------------------	---------------------------------------------------------------------------------------

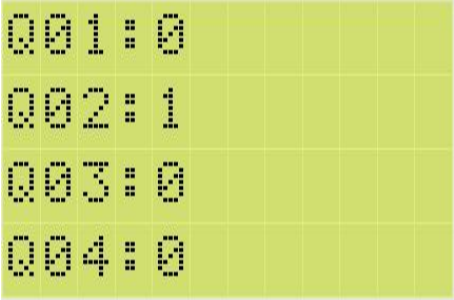
	<p>Q – Output 01 – Output number (1 – 4 or 1-8) :0 – Output state: 0 – Low state on the output 1 – High state on the output</p>
-----------------------------------------------------------------------------------	----------------------------------------------------------------------------------------------------------------------------------------------------------------------------------------





2. Opening other resources.

To open other resources, follow the same instructions as described for the Timer.

3. Changing the Input number.

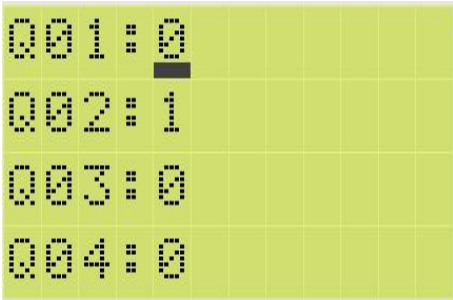
To change the Output number (e.g. from Q5 to Q2), follow the same instructions as described for the Timer.

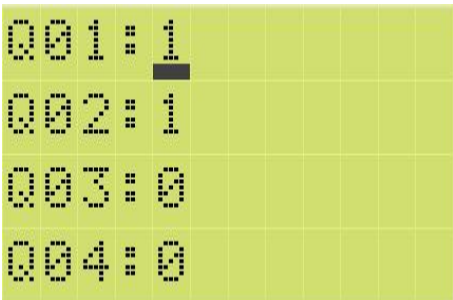
4. On/Off Output.

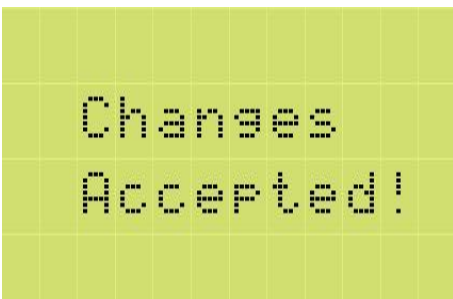
<p>Move the cursor to the field shown here (keep pressing right arrow until the cursor will be in the appropriate field).</p> 	
<p>Press up/down arrow to SET/RESET Output</p>  <p>or</p> 	
<p>Press OK to accept changes</p> 	



If the output state is forced in the LAD/STL program, a given output state will not be changed

10.3.1.8. Buttons menu

1. Opening the Buttons configuration screen.

<pre> Inputs Outputs >Buttons H.SpeedCnt </pre>	
<pre> B1: 0 B2: 0 B3: 1 B4: 0 </pre>	<p>B – Button 1 – Button number :0 – Button state: 0 – Button in 1 – Button off</p>

2. Opening other resources.

To open other resources, only press ESC.

10.3.1.9. Fast Counter menu





1. Opening the Fast Counter configuration screen.

<pre> Inputs Outputs Buttons >H.SpeedCnt </pre>	
<pre> HC: 0 C/f: C #: 24000 \$: 4001 </pre>	<p>HC – Fast Counter :0 – Fast Counter output state: 0 – Fast Counter output off 1 – Fast Counter output on C/f – Counter / Frequency Meter #: – Fast Counter threshold :\$: – Current Fast Counter value</p>

2. Opening other resources.

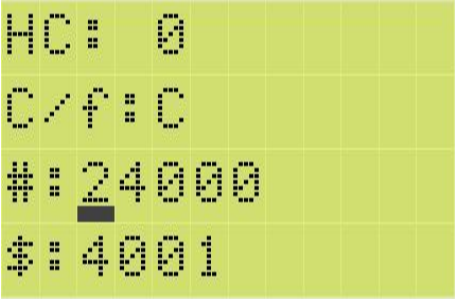
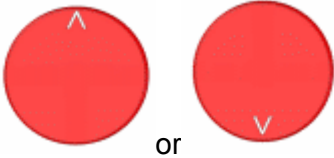
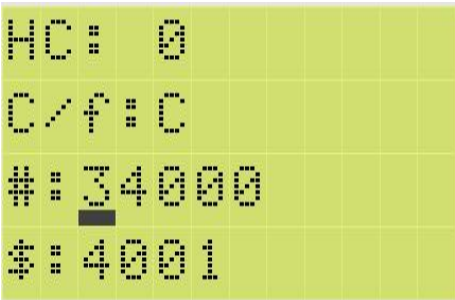

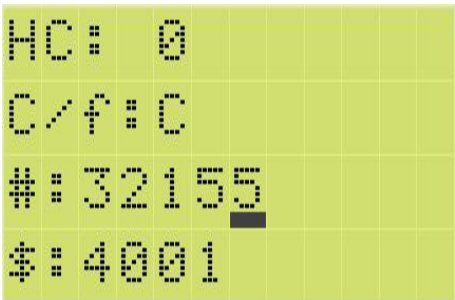
To open other resources, follow the same instructions as described for the Timer.

3. Setting threshold for Fast Counter.

<p>Move the cursor to the field shown here (keep pressing right arrow until the cursor will be in the appropriate field)</p> 	
<p>Press up/down arrow to set a demand threshold for Fast Counter</p> 	
<p>Move the cursor to next fields (keep pressing right arrow until the cursor is in the appropriate field) and set the desired value as described above.</p> 	
<p>Setting threshold for Fast Counter HC: 32155 Press OK to accept changes.</p> 	

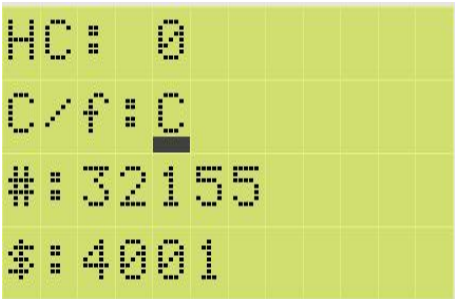

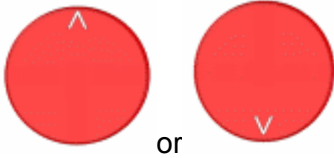
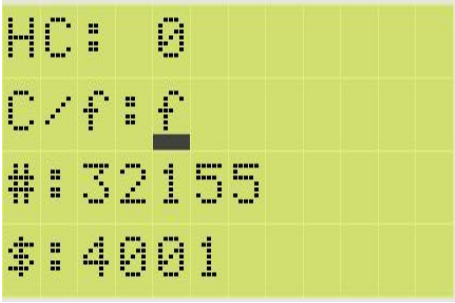
4. Setting the operating mode: frequency measurement or impulse count.

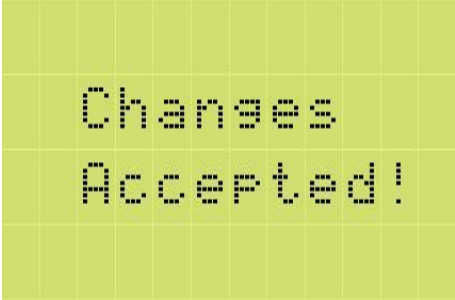
<p>Move the cursor to the field shown here (keep pressing right arrow until the cursor will be in the appropriate field).</p> 	
-------------------------------------------------------------------------------------------------------------------------------------------------------------------------------------------------------------------	--------------------------------------------------------------------------------------

<p>Press up/down arrow to choose a appropriate mode: C – Counter, f – frequency meter.</p>  <p style="text-align: center;">or</p>	
<p>Setting a mode: frequency meter Press OK to accept changes.</p> 	

10.3.1.10. ASYM & MDIR menu

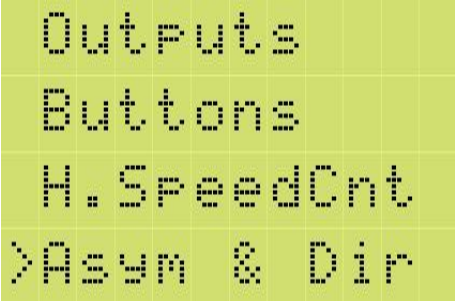
1. Opening the ASYM & MDIR configuration screen.



	
	<p>The Parameter ASYM is equals 43V and Marker MDIR is 1.</p>

10.3.2. System menu





System menu enables:

- setting the LCD display backlight type
- choosing the LCD module interface language.

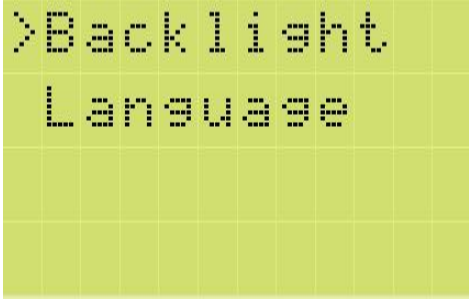

Opening the System menu screen

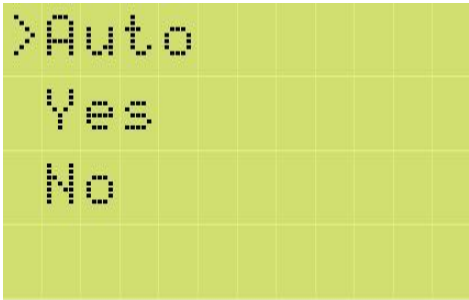
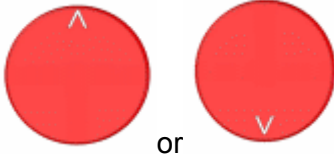

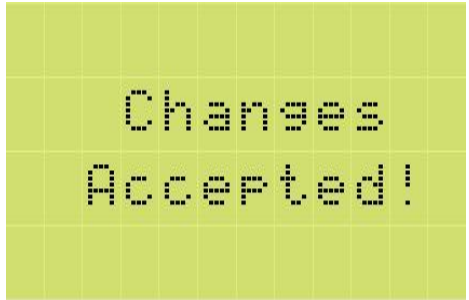

<pre>>Confis Time Date Alarms</pre>	
<pre>>Settinas System Password Version</pre>	<p>Move one line down using:</p> 
<pre>Settinas >System Password Version</pre>	
<pre>>Backlight Language</pre>	<p>System menu: >Backlight – set the LCD display backlight type >Language – choose the LCD module interface language.</p>

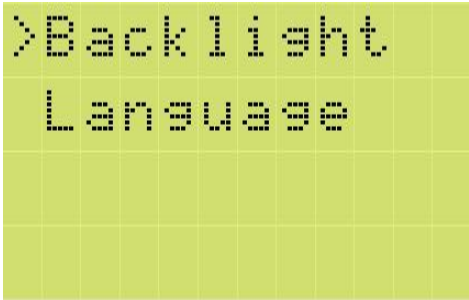
10.3.2.1. Backlight

	
	<p>Use the keys to set the backlight type:</p> 
<p>>Auto – backlight switches off when the keyboard is not used for 5 s. >Yes – backlight is always on >No – backlight is off.</p>	
	





10.3.2.2. Language

	<p>Move one line down:</p> 
-------------------------------------------------------------------------------------	------------------------------------------------------------------------------------------------------------------



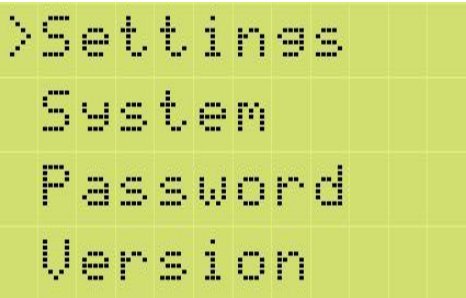

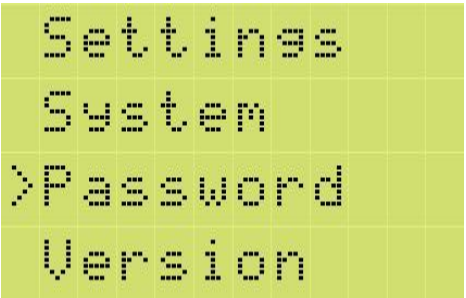
<pre>Backlight >Language</pre>	
<pre>>English Deutsch Polski Русский</pre>	<p>press up/down arrow to choose module interface language</p>  <p>or</p> 
<pre>>English – English language >Deutsch – German language >Polski – Polish language >Русский – Russian language</pre>	
<pre>Changes Accepted!</pre>	

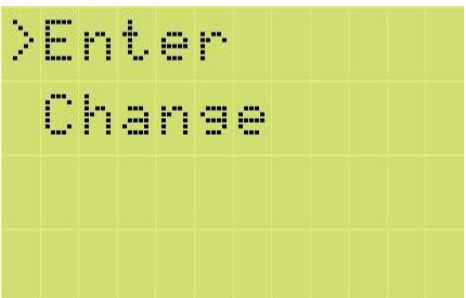

10.3.3. Password Menu

<pre>>Config Time Date Alarms</pre>	
----------------------------------------	---------------------------------------------------------------------------------------

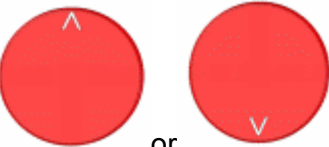
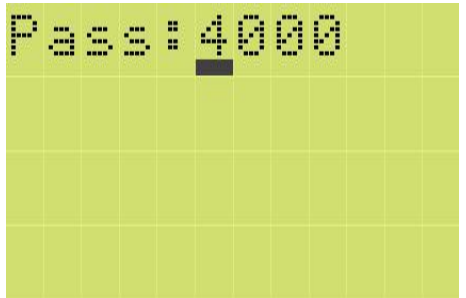

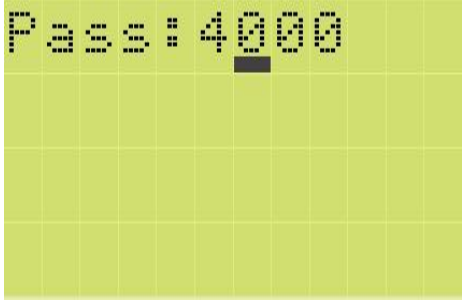
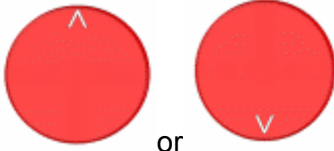

	<p>Move 2 line down:</p> 
	





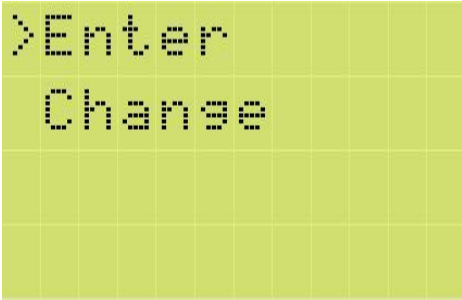

10.3.3.1. Password enter

	
	<p>Use up/down arrow to set the first digit of your password</p>  <p>or</p>
	<p>Move the cursor to the next password digit. (press right arrow)</p> 

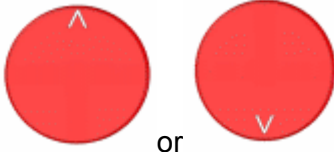
	<p>Use up/down arrow to set the 2 digit of your password</p>  <p>or</p>
<p>Set the second and remaining password digits.</p>	<p>Confirm your password:</p> 
	

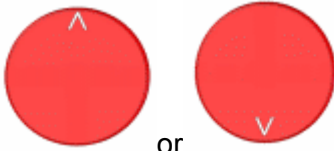

10.3.3.2. Password change

	<p>Move one line down:</p> 
	

	<p>Use up/down arrow to set the first digit of your old password</p> 
	<p>Move the cursor to the next password digit. (press right arrow)</p> 
<p>Set the 2, 3, 4 digit of your old password.</p>	<p>Move the cursor to second line (press right arrow)</p> 
	<p>Use up/down arrow to set the first digit of your new password</p> 
	<p>Set the second and remaining password digits.</p>







<pre> Curr: 4178 New: 2037 </pre>	<p>Confirm your password:</p> 
<pre> Changes Accepted! </pre>	







10.3.4. Version Menu





<pre> >Confis Time Date Alarms </pre>	
<pre> >Settings System Password Version </pre>	<p>Move 3 line down using:</p> 
<pre> Settings System Password >Version </pre>	

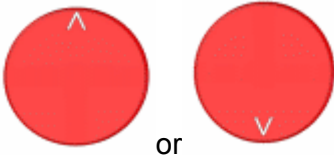

 <p>NEED MAX DISPLAY 24DC-22-16 -8 v1.00</p>	<p>Information about relay firmware type and version.</p>
-------------------------------------------------------------------------------------------------------------------------------------------	-----------------------------------------------------------

10.4. Time Menu

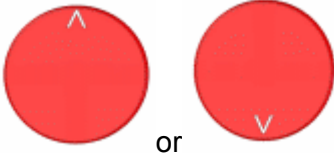

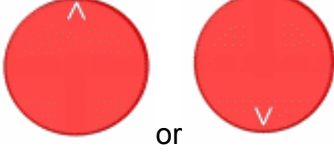



<pre>>Confis Time Date Alarms</pre>	<p>Move one line down using:</p> 
<pre>Confis >Time Date Alarms</pre>	
<pre>Time: 14:41:25 Time Zone NONE</pre>	<p>Use up/down arrow to set tens of hours</p>  <p>or</p> 
<pre>Time: 04:41:25 Time Zone NONE</pre>	<p>Move the cursor to the next digit - hours (press right arrow)</p> 
<pre>Time: 04:41:25 Time Zone NONE</pre>	<p>Use up/down arrow to set hour</p>  <p>or</p> 





<p>Time: 03:41:25 Time Zone NONE</p>	<p>Move the cursor to the next field – tens of minutes (press right arrow)</p> 
<p>Time: 03:41:25 Time Zone NONE</p>	<p>Use up/down arrow to set tens of minutes</p>  <p>or</p> 
<p>Time: 03:51:25 Time Zone NONE</p>	<p>Move the cursor to the next digit – minutes (press right arrow)</p> 
<p>Time: 03:51:25 Time Zone NONE</p>	<p>Use up/down arrow to set minute</p>  <p>or</p> 
<p>Time: 03:54:25 Time Zone NONE</p>	<p>Move the cursor to the next field – tens of seconds (press right arrow)</p> 





<p>Time: 03:54:25 Time Zone NONE</p>	<p>Use up/down arrow to set tens of seconds</p>  <p>or</p>
<p>Time: 03:54:05 Time Zone NONE</p>	<p>Move the cursor to the next digit – seconds (press right arrow)</p> 
<p>Time: 03:54:05 Time Zone NONE</p>	<p>Use up/down arrow to set seconds</p>  <p>or</p>
<p>Time: 03:54:02 Time Zone NONE</p>	<p>Move the cursor to the next field – Time Zone (press right arrow)</p> 
<p>Time: 03:54:02 Time Zone NONE</p>	<p>Choose the time zone using</p>  <p>or</p>

 <p>Time: 03:54:02 Time Zone US</p>	<p>Time zone selection: NONE EU o 1:00 EU o 2:00 EU o 3:00 RU US</p>
 <p>OK</p>	 <p>Changes Accepted!</p>

10.5. Date Manu

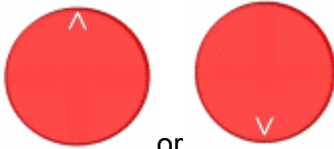
<pre>>Confis Time Date Alarms</pre>	<p>Move 2 line down using:</p> 
<pre>Confis Time >Date Alarms</pre>	
<pre>Date 2001.01.01 yyyy.mm.dd</pre>	<p>Use up/down arrow to set tens of years</p>  <p>or</p> 
<pre>Date 2011.01.01 yyyy.mm.dd</pre>	<p>Move the cursor to the next digit – units of years (press right arrow)</p> 
<pre>Date 2011.01.01 yyyy.mm.dd</pre>	<p>Use up/down arrow to set year</p>  <p>or</p> 

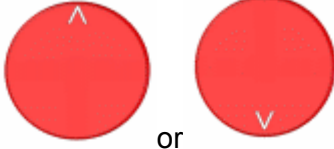

<p>Date 2010.01.01 yyyy.mm.dd</p>	<p>Move the cursor to the next field – tens of months (press right arrow)</p> 
<p>Date 2010.01.01 yyyy.mm.dd</p>	<p>Use up/down arrow to set tens of months</p>  <p>or</p> 
<p>Date 2010.11.01 yyyy.mm.dd</p>	<p>Move the cursor to the next digit – months (press right arrow)</p> 
<p>Date 2010.11.01 yyyy.mm.dd</p>	<p>Use up/down arrow to set month</p>  <p>or</p> 
<p>Date 2010.12.01 yyyy.mm.dd</p>	<p>Move the cursor to the next field – tens of days (press right arrow)</p> 

<p>Date 2010.12.01 yyyy.mm.dd</p>	<p>Use up/down arrow to set tens of days</p> 
<p>Date 2010.12.31 yyyy.mm.dd</p>	<p>Move the cursor to the next digit – day (press right arrow)</p> 
<p>Date 2010.12.31 yyyy.mm.dd</p>	<p>Use up/down arrow to set day</p> 
<p>Date 2010.12.30 yyyy.mm.dd</p>	<p>Confirm changes</p> 
<p>Changes Accepted!</p>	

10.6. Alerts menu

State preview, setting Text Markers, viewing alert texts assigned to Text Markers.

1. Opening Alerts menu



<pre>>Confis Time Date Alarms</pre>	<p>Move 3 line down using:</p> 
<pre>Confis Time Date >Alarms</pre>	
<pre>MT01:0 >> MT02:0 >> MT03:0 >> MT04:0 >></pre>	<p>Alarms MTx MT – Text Marker 01 – No Marker (1 – 8) :0 – State preview 0 – Text Marker Off 1 – Text Marker On >> - viewing alert texts assigned to Text Markers</p>

2. Changing the scope viewing Text Markers

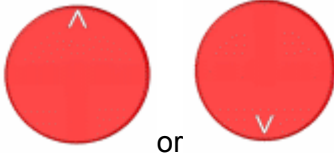

<pre>MT01:0 >> MT02:0 >> MT03:0 >> MT04:0 >></pre>	<p>The display shows 4 subsequent Text Markers simultaneously. To change the scope, move the cursor to the number field (MT0<u>1</u>) and go down by pressing down arrow.</p> 
----------------------------------------------------------------------------	----------------------------------------------------------------------------------------------------------------------------------------------------------------------------------------------------------------------------------------------------------------------------

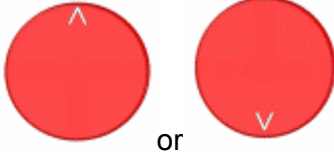
<pre> MT02: 0 >> MT03: 0 >> MT04: 1 >> MT05: 0 >> </pre>	<p>Press the key again to continue changing the scope. (use up/down arrow)</p> 
----------------------------------------------------------------------------------	-------------------------------------------------------------------------------------------------------------------------------------------------------------------

3. Setting Marker state

<pre> MT01: 0 >> MT02: 0 >> MT03: 0 >> MT04: 0 >> </pre>	<p>Move the cursor from the Text Marker number field to the state field (use right arrow)</p> 
<pre> MT01: 0 >> MT02: 0 >> MT03: 0 >> MT04: 0 >> </pre>	<p>Use up/down arrow to set/reset Text Marker</p> 
<pre> MT01: 1 >> MT02: 0 >> MT03: 0 >> MT04: 0 >> </pre>	<p>Confirm changes</p> 
<pre> Changes Accepted! </pre>	

4. Preview alert texts

<pre> MT01:0 >> MT02:0 >> MT03:0 >> MT04:0 >> </pre>	<p>Move the cursor to the field >>(press right arrow)</p> 
<pre> MT01:0 >> MT02:0 >> MT03:0 >> MT04:1 >> </pre>	<p>Press up arrow to view the alert text assigned to MTx.</p> 
<pre> MT1 Alarm Time:12.10 </pre>	<p>Press ESC to return to the Alerts screen.</p> 

10.7. External Memory menu



Allows you to save relay settings in external memory.

1. Opening the Memory configuration screen

<pre> >Config Time Date Alarms </pre>	<p>Move 3 line down using:</p> 
--------------------------------------------------	----------------------------------------------------------------------------------------------------------------------

<pre> Time Date Alarms >Memory </pre>	
--------------------------------------------------	-------------------------------------------------------------------------------------

2. Operations concerning saving in external memory

<pre> No Memory Detected! </pre>	<p>Message shown if external memory is missing.</p>
<pre> Write operation in STOP mode only </pre>	<p>Message about stopping the program executed by the relay. Once stopped (STOP), press OK to start the procedure of saving.</p> 
<pre> Wr.in.Progr. ***..... ***** ***** </pre>	<p>Information on the progress of saving.</p>
<pre> Writing completed </pre>	<p>Saving completed – press ESC to confirm the message and finish saving.</p> 

11. SAMPLE APPLICATIONS

11.1. Part height assessment

Quite frequently a need arises during the manufacturing process to sort the parts according to their dimensions. The task can be performed manually by measuring the certain dimension or automatically, using the NEED programmable relay together with several external sensors. If e.g. only two height categories are involved, it takes the NEED programmable relay and two sensors detecting the geometric dimension in a proper manner to compose the full control set.

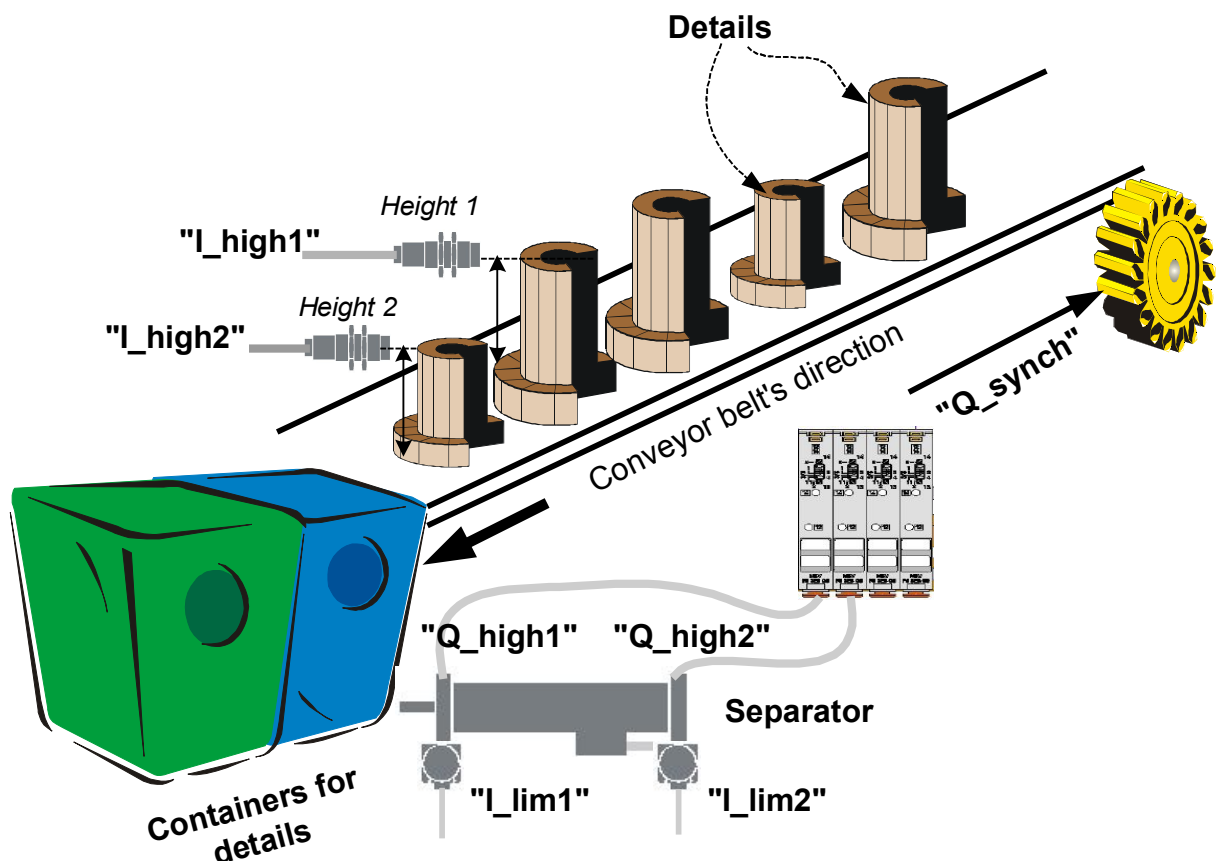

Fig. 11.1.1. Part height detection.

Task description:

Parts transported on the impulse feeder must be sorted according to their heights.

Equipment selection:

- 1) In order for the task to be performed properly two sensors must be selected of the proper range. If the parts are made of metal, induction sensors can be used to detect height. Let's the name of the sensor for height 1 detection (high details) be "I_high1" while the sensor detecting the height 2 (low details) be "I_high2". Assumption is made that the belt movement is synchronized so a signal to enable the restarted belt movement (let's call it "Q_synch") is also necessary.
- 2) Separator can be a pulse solenoid valve-controlled cylinder (on sending a control signal to one electromagnet coil the valve remains in that position also after the signal has faded, until a signal is sent to the other coil) on which two containers are fixed. "Height 1 of the parts" and "Height 2 of the parts" will stand for extreme positions of the

cylinder. Let's name the outputs controlling the electromagnets "Q_high1" and "Q_high2" with corresponding extreme position sensors "I_lim1" and "I_lim2".

3) Programmable relay: 4 inputs and 3 outputs are necessary.

Fig. 11.1.1. illustrates the concept of the task analysed while the electrical connection diagram is presented in Fig. 11.1.2.

Algorithm:

First the height of the parts will be checked. If sensor "I_high1" is actuated it means the part is a higher one. If sensor "I_high2" is actuated with "I_high1" not being actuated the part is a lower one. Depending on the height the container is moved (the output connected to the solenoid valve is switched on) towards higher or lower parts respectively. After the operation completion (once the container is set to the proper part type) synchronization signal for belt movement is sent. The detailed operation algorithm is presented below.

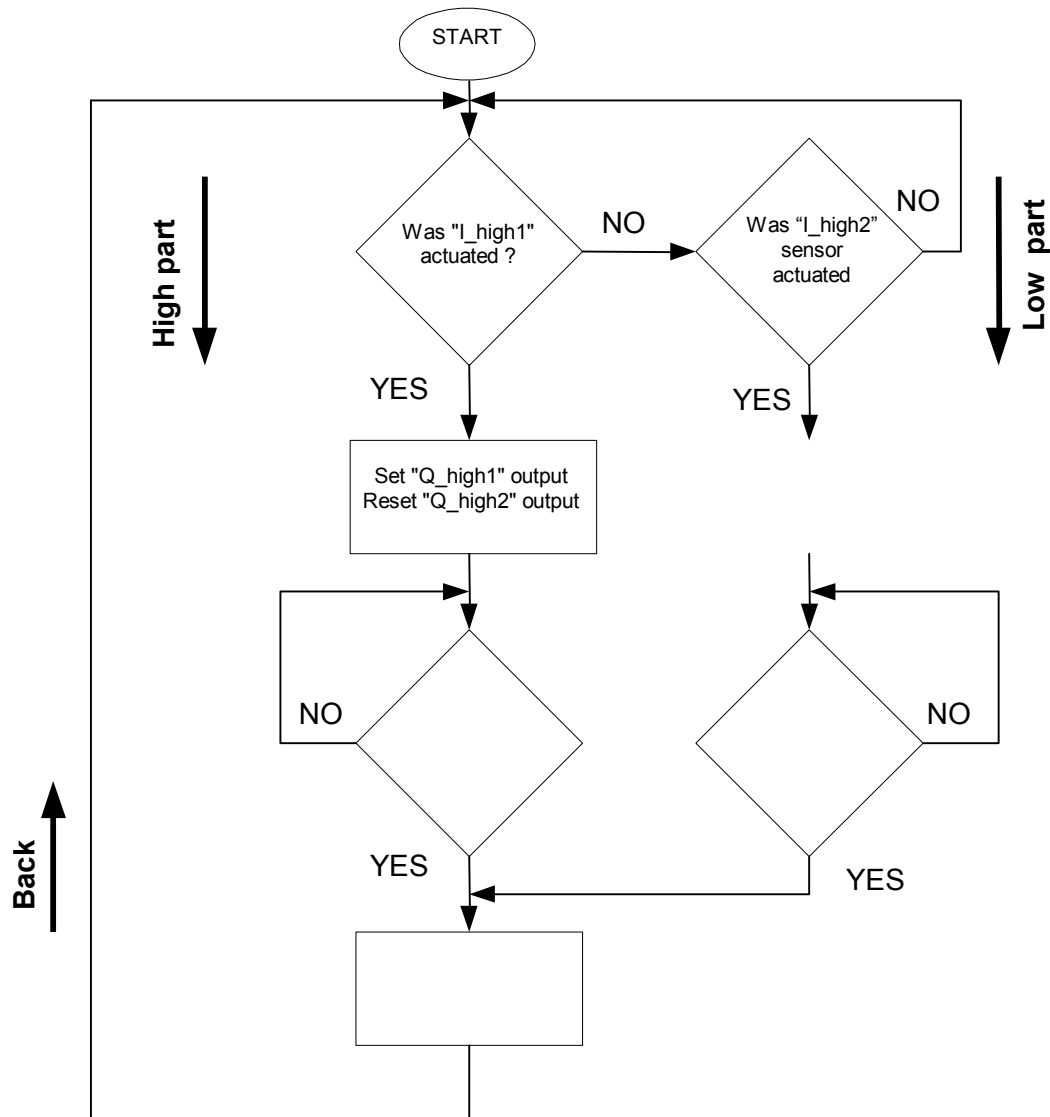

It must be noted that the program execution does not "stop" at any point. The controller does not wait for any starting signal, the program is simply processed from the first to the last line.

Program

Let's arrange our equipment configuration

Address	Inputs	Address	Outputs
I1	„I_high1”	Q1	„Q_high1”
I2	„I_high2”	Q2	„Q_high2”
I3	„I_lim1”	Q3	„Q_synch”
I4	„I_lim2”		

Now let's try to translate the algorithm to the programming language.

STL

```
//High detail detection
A I1          //If I1=1, then set Q1. If I1=0 do not do anything
AN T1        // T1 Timer must be at low state
S Q1         //Set the container to „high”
R Q2         //Q2=0, Q1=1

//Low part detection
AN I1        //High part detection sensor is not operating I1=0 and
A I2         // low part detection sensor I2=1
AN T1        // T1 Timer must be at low state
S Q2         // Set the container to „low”
R Q1         //Q2=1, Q1=0

//High part
//I3 limit sensor detection at the cylinder
A I3         //If a leading edge occurs at I3
A Q1         //and Q1 is set
=M1         //then set M1 Marker

//Low part
//I4 sensor detection at the cylinder
A I4         // If a leading edge occurs at I4
A Q2         // and Q2 is set
=M2         // then set M2 Marker

//Detection of gap between the parts
AN I1        //No "high" part
AN I2        //No low part
R M1         //Resetting auxiliary M1, M2 Markers
R M2

//Releasing T1 Timer for synchronization
O M1         //If M1 Marker or
O M2         // M2 Marker is at state '1'
L 1s        //then release T1 Timer1 in the Single Pulse mode
SE T1       //with the duration time of 1s

A T1         //Set Q3 according to T1
=Q3
```

T1 Timer was used to generate the pulse in the Single Pulse mode. It means that the occurrence of a leading edge at I3 or I4 input will cause a single synchronization pulse to be generated at Q3.

The LAD language version of the program is presented below.

LAD

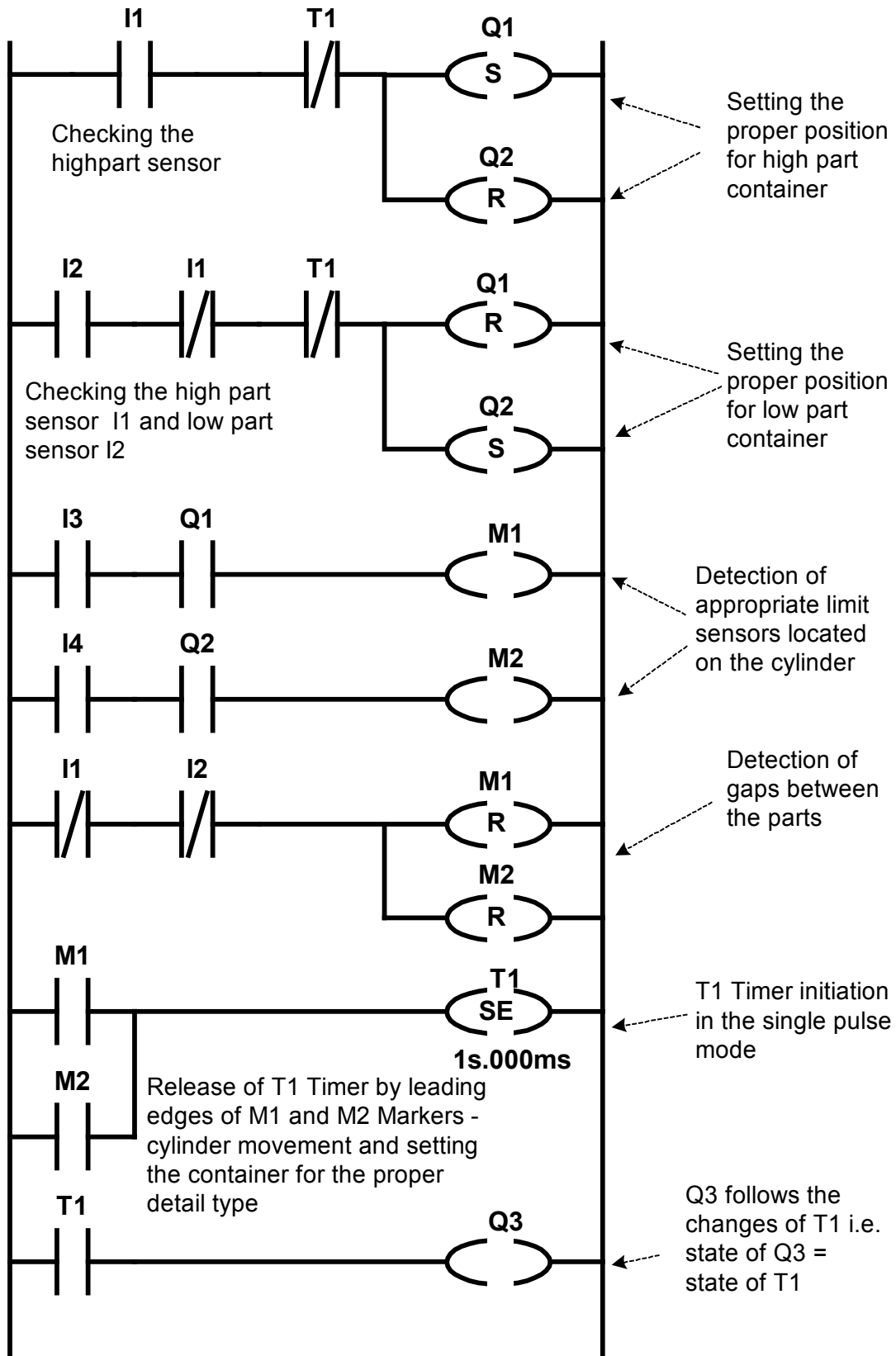

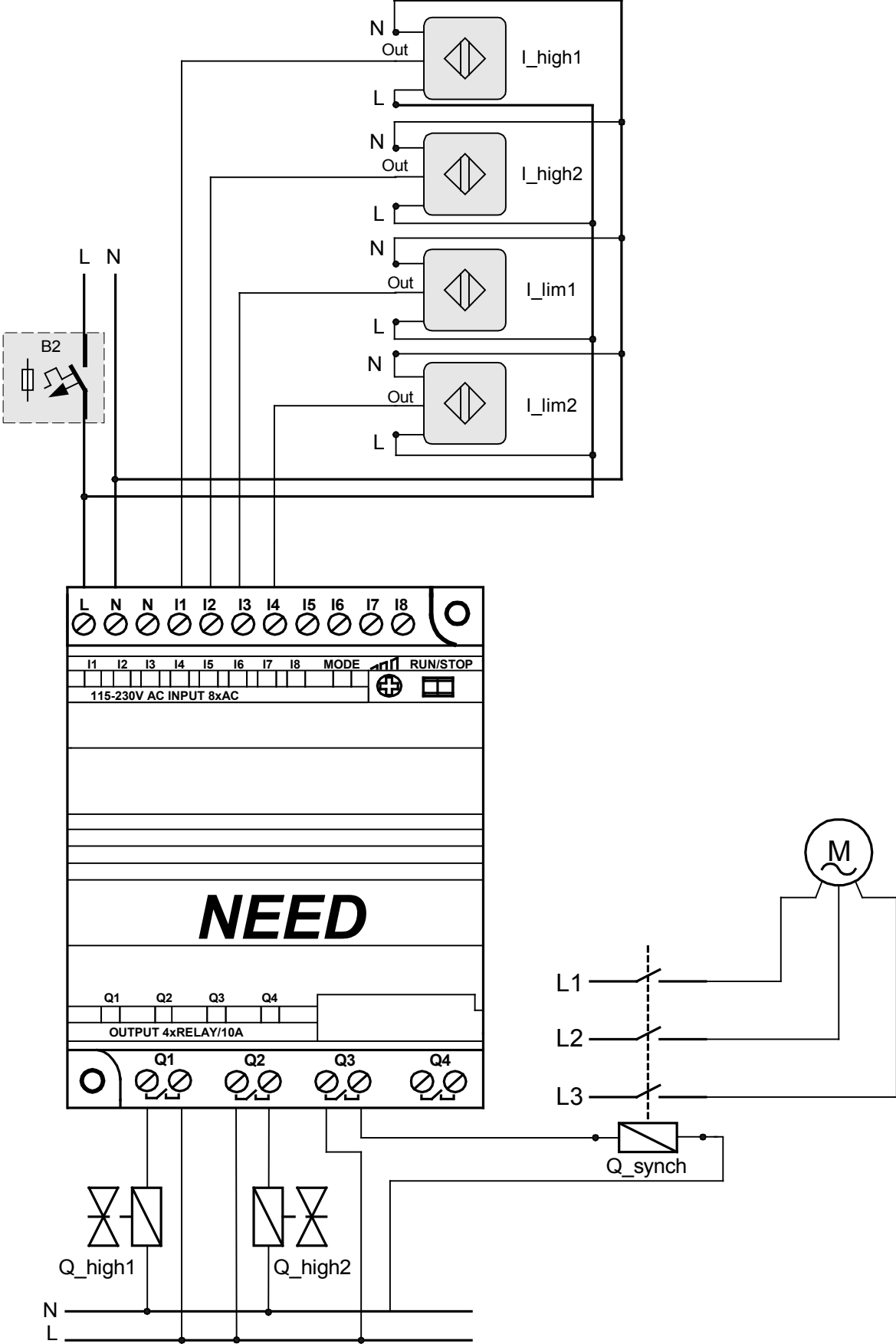

Fig. 11.1.2. Sample electric connection diagram of the circuit for part height detection.

11.2. Automatic door

Everyone knows the automatic door control. Automatic doors are very often used at stores, offices, banks etc. but the NEED programmable relay can „enrich” the conventional control with new functions to improve not only the customer traffic but also the functionality of the entire building.

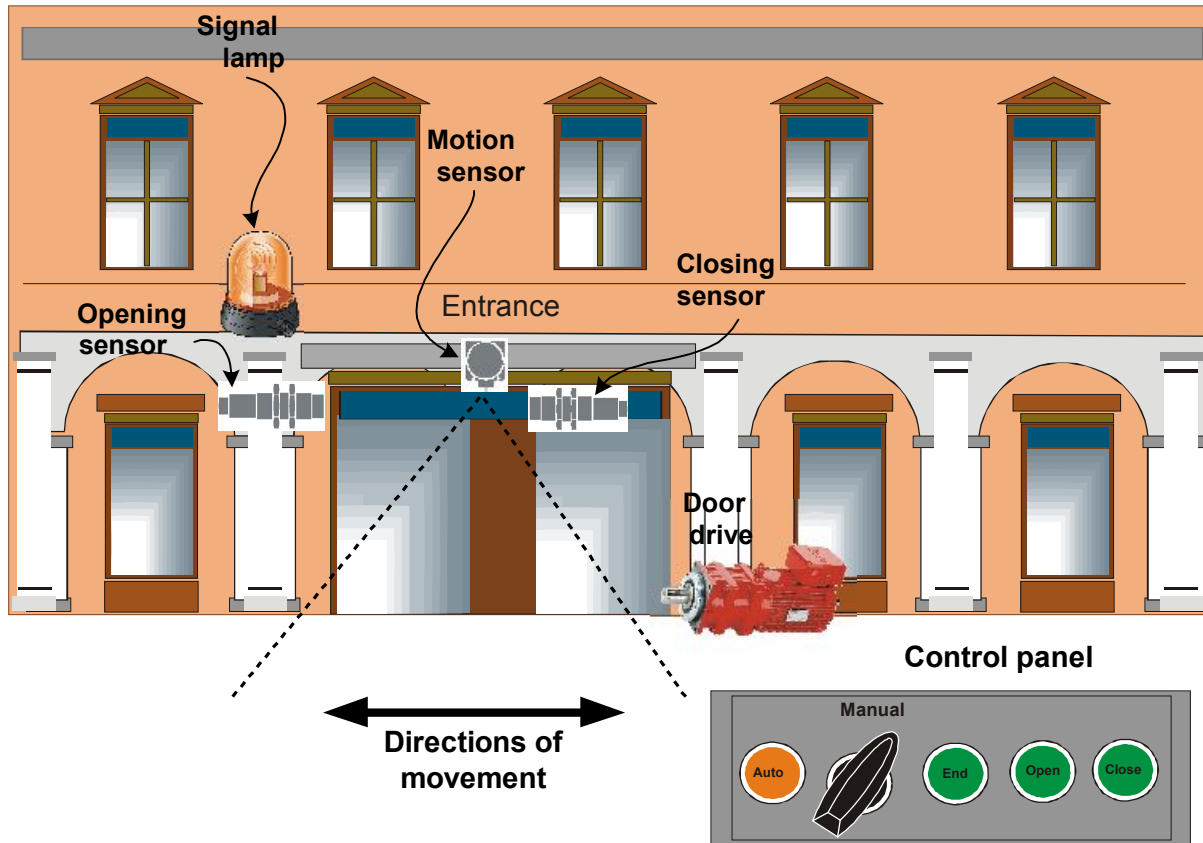

Fig. 11.2.1. Automatic door control.

Task description:

Control the opening and closing of automatic door in a building.

1. A proper motion sensor must be selected. The sensor range must be such that the traffic is not hampered due to the door response time i.e. the door must open well before the customer enters the doorway. May the outer sensor be named "I_out" and the inner one "I_in". In order for the door position to be detected also extreme position sensors must be installed. The position sensors' names will be "I_open" for open door sensor and "I_close" for closed door sensor. In order to improve the functionality a switch may be added to enable setting of 3 operating modes: *Auto* – the entire system operates as during regular working hours, *End* – door opens only for the people leaving the building. It is a good rule to equip the control system with manual mode so our system will also have "Open" and "Close" buttons to manually open and close the door in the *Manual* mode (neither *Close* nor *Auto* are on). All the buttons will be put in one place – a control panel.
2. Door should be driven by a motor with an anti-clasp coupling. The signal to control the motor operation will be "Q_close" (forward movement – closing – contactor on, backward movement – opening – contactor off) and "Q_motor" – output switching the motor on. The system will be additionally equipped with a signal lamp "Q_alarm" which will be blinking during "Closing" of the store.
3. NEED programmable relay – 8 inputs and 3 outputs will be necessary.

Algorithm

First, the operating mode must be defined which is signaled by the lamp (in this case the lamp blinks for the *Closing* mode). The door is to open when the signal at the motion detector output is high. In order to avoid actuation caused by incidental releases the system responds only after 200ms i.e. if after 200ms from the release the motion is still detected by the motion sensor, the door starts opening. The delay time must be obviously adjusted so that the person leaving or entering does not wait for the door to open (appropriate adjustment and sensitivity of motion detectors are involved).

After opening the door remains open for about 5 seconds and it closes afterwards. Each motion detected during the closing operation causes the door to open again. Limit sensors are used to stop the door movement.

If *Manual* mode is selected the door opening is performed by pushing the *Open* button.

Algorithm

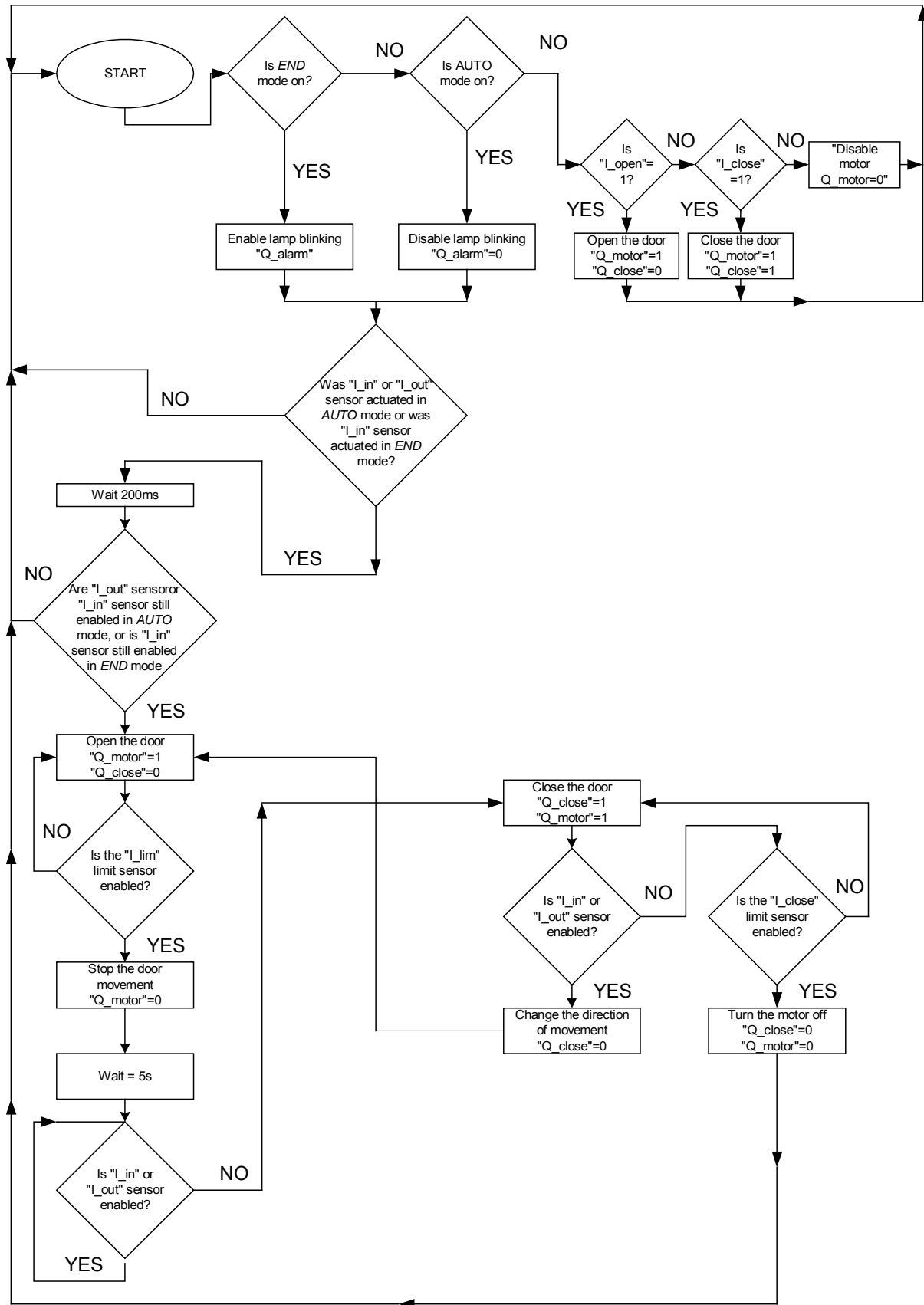

Program
Equipment configuration:

Address	Inputs	Address	Outputs
I1	„I_in”	Q1	„Q_close”
I2	„I_out”	Q2	„Q_motor”
I3	„I_open”	Q3	„Q_alarm”
I4	„I_close”		
I5	„Auto”		
I6	„End”		
I7	„Close”		
I8	„Open”		

STL

```

O I1 //Enter M1 Marker to inform
O I2 // about actuation of any of the motion sensors („I_in” or „I_out”).
=M1

A M1 // M2 Marker is set if „Auto” mode was selected and
A I5 // motion was detected outside and inside the building
=M2

A I1 // M3 Marker is set if „Close” mode was selected and
A I6 // motion was detected inside the building
=M3

AN I5 //Setting the operating mode to „Manual”
AN I6
=M13 //Marker of the „Manual” operating mode

A I6 // I6 as a signal triggering T3
L 1s // Timer 3 setting to blinking mode (pulse length: 1s)
SL T3

A T3 //Switching the signal lamp on for the „Closing” operating mode
=Q3

O M2 // M4 Marker is set if motion was detected
O M3 // at any of the sides in any of the modes
= M4

A M4
L 200ms //Delay of 200ms generated by T1 Timer in
SD T1 //Single Pulse mode

A T1 //Setting the M6 auxiliary Marker after 200ms from
S M6 //triggering – actuation of any of the motion sensors

A T1 //Checking after 200ms if a sensor at any of the sides detects motion
A M4
R M5 //Determination of door movement direction – opening

```

A M6 //Entrance door motor operation
AN I3 //until the actuation of I3 sensor
= M16

A M6 // Entrance door motor operation
AN I4 // until the actuation of I3 sensor = M15

O M15 //Turning the door motor on or off
O M16
=Q2

A I3 //Triggering the T2 Timer operating in the Delayed On mode
L 5s //i.e. setting a „fixed” door opening time
SD T2
R M6 //Resetting M6 Marker

A T2 //Setting M5 auxiliary Marker
AN M4
S M5

A M5 //Turning Q1 off once
AN I4 //the limit position signaled by I4 is reached
=Q1

A I7 //Manual door closing – movement – button pressed
A M13
S Q1
S Q2

AN I7 //Manual mode –stop.
A M13
R Q1
R Q2

A M13 //Manual opening of the door – movement – button pressed
A I8
S Q2

LAD

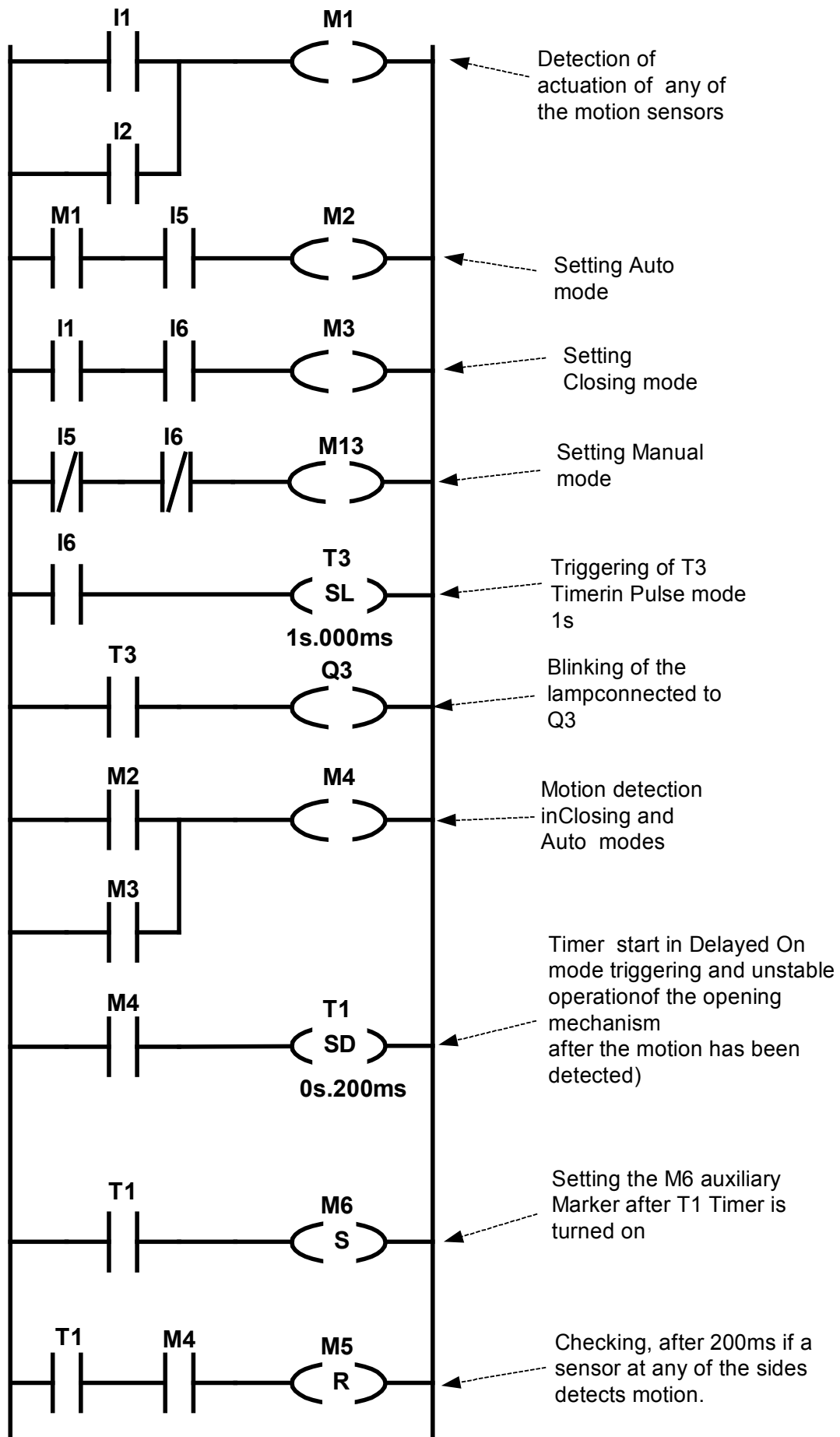

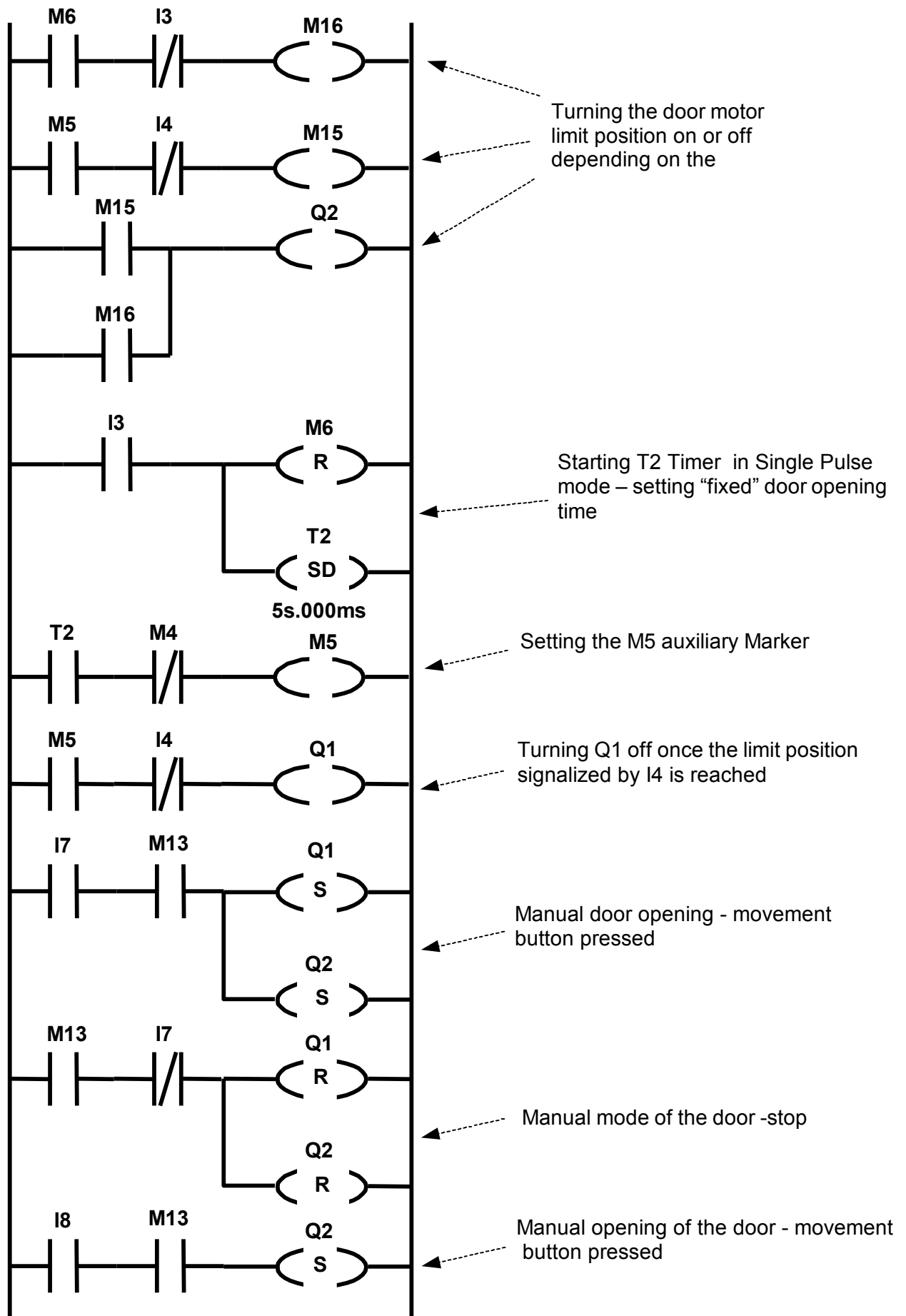

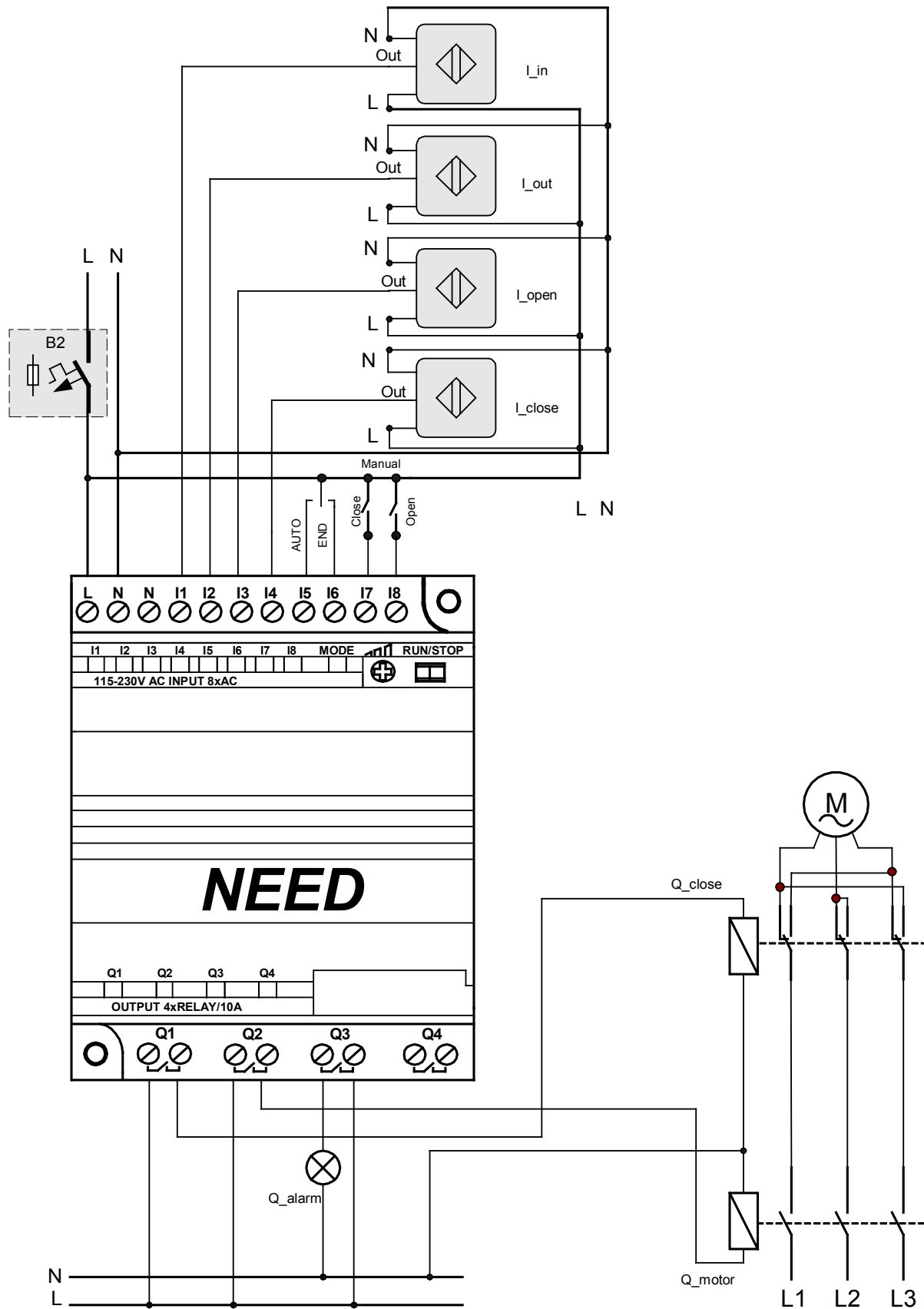

Fig. 11.2.2. Sample electric connection diagram to control the automatic door operation.

11.3. School bells

Quite frequently timers/clocks are installed at schools, plants to actuate specific devices (bells, alarms, heaters etc.) at pre-selected times. By using the NEED programmable relay you can create your own simple time control system which is better adapted to the local requirements and needs.

Task description:

Create a “bell-ringing” system based on the below class schedule

Class	Duration	Break bell		Class bell	
		On- start	Off-start	On-start	Off-start
Class 1	8.00 a.m. – 8.45 a.m.	8.45 a.m.	8.46 a.m.	8.49 a.m.	8.50 a.m.
Class 2	8.50 a.m.– 9.35 a.m.	9.35 a.m.	9.36 a.m.	9.39 a.m.	9.40 a.m.
Class 3	9.40 a.m.– 10.25 a.m.	10.25 a.m.	10.26 a.m.	10.34 a.m.	10.35 a.m.
Class 4	10.35 a.m.– 11.20 a.m.	11.20 a.m.	11.21 a.m.	11.49 a.m.	11.50 a.m.
Class 5	11.50 a.m.– 12.35 p.m.	12.35 p.m.	12.36 p.m.	12.44 p.m.	12.45 p.m.
Class 6	12.45 p.m.– 1.30 p.m.	1330 p.m.	1.31 p.m.	1.39 p.m.	1.40 p.m.
Class 7	1.40 p.m.– 2.25 p.m.	2.25 p.m.	2.26 p.m.	2.34 p.m.	2.35 p.m.
Class 8	2.35 p.m. – 3.20 p.m.	3.20 p.m.	3.21 p.m.	3.29 p.m.	3.30 p.m.

Equipment selection:

- 1) Select an appropriate panel with buttons to allow manual bell control and turning the bells off at preset periods e.g. during winter/summer holidays, Christmas holidays, on Saturdays etc.

Let's assign the name as follows:

- Manual mode switch – “I_manual” (only “manual bell ringing” available in that mode).
- Automatic switch mode – “I_auto”.
- Button to turn the bell on in the manual mode – “I_on”.

- 2) NEED programmable relay: 3 inputs, 1 output.

Program

Equipment configuration:

Address	Inputs	Address	Outputs
I1	„I_manual”	Q1	„Q_bell”
I2	„I_auto”		
I3	„I_on”		

Algorithm

To turn the bell on and off *Clocks* will be used in the below configuration:

Clock 1

The screenshot shows the 'Calendar settings' window for 'Clock 1'. The window title is 'No file name (SET)*'. It has a menu bar with 'Timer', 'Calendar', 'Counter', 'Comparator', 'Remanent', and 'Input settings'. The 'Calendar settings' section includes a 'H:' dropdown set to '1'. Below are four channels (A, B, C, D) with the following settings:

Channel	Day 1	Day 2	On HH	On MM	Off HH	Off MM
Channel A	Mon	Sat	8	45	8	46
Channel B	Mon	Sat	8	49	8	50
Channel C	Mon	Sat	9	35	9	36
Channel D	Mon	Sat	9	39	9	40

Clock 2

The screenshot shows the 'Calendar settings' window for 'Clock 2'. The window title is 'No file name (SET)*'. It has a menu bar with 'Timer', 'Calendar', 'Counter', 'Comparator', 'Remanent', and 'Input settings'. The 'Calendar settings' section includes a 'H:' dropdown set to '2'. Below are four channels (A, B, C, D) with the following settings:

Channel	Day 1	Day 2	On HH	On MM	Off HH	Off MM
Channel A	Mon	Sat	10	25	10	26
Channel B	Mon	Sat	10	34	10	35
Channel C	Mon	Sat	11	20	11	21
Channel D	Mon	Sat	11	49	11	50

Clock 3

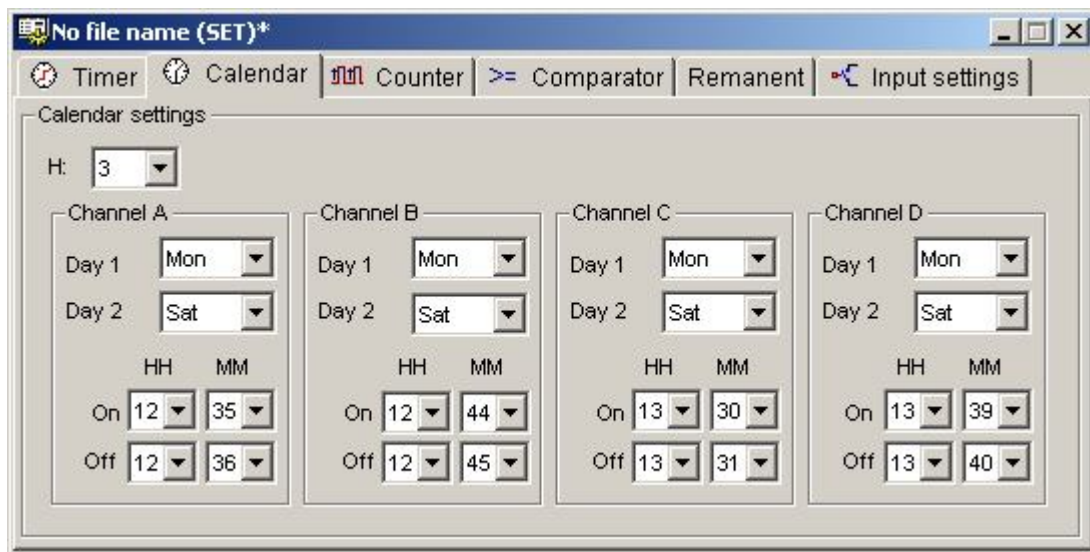

Clock 4

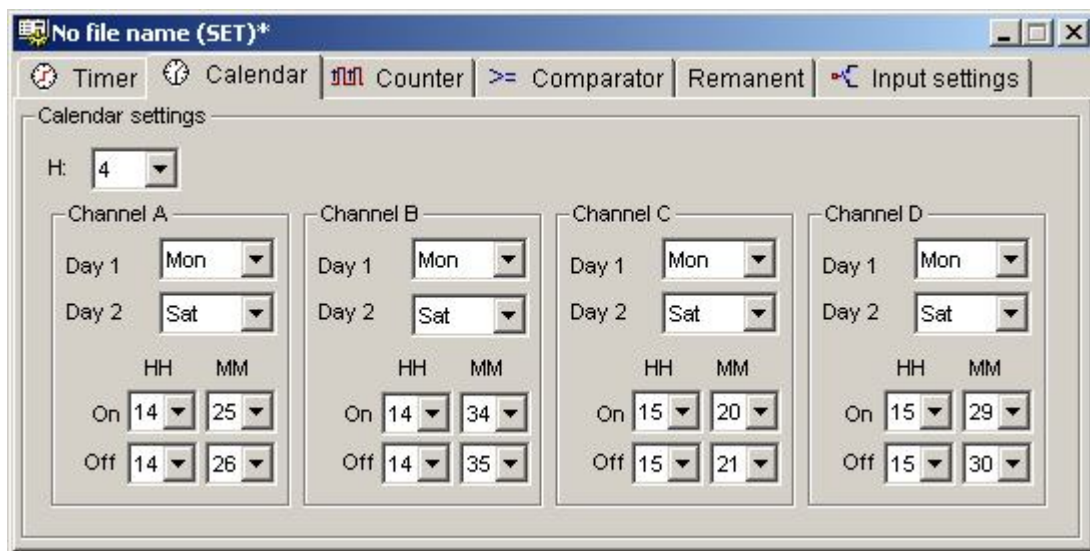

There is one inconvenience that must be pointed out. The *Clocks* can be adjusted with 1 minute accuracy. So how to handle bells of durations of e.g. 7 seconds only? (one minute ringing time is too long). The *Timer* in Single Pulse mode can be used to allow the adjustment of the ringing times. Methods to enable and disable the bell are presented in Fig. 11.3.2.

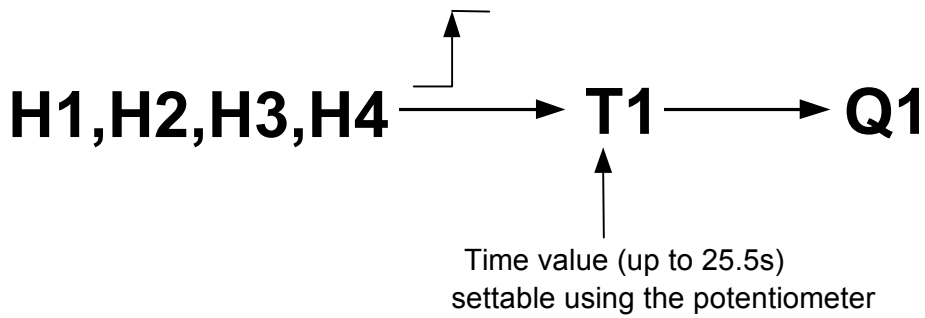

Fig. 11.3.1 Bell control method.

Of course, the Potentiometer allow only a rough setting of time values but it gives fairly satisfying results in determination of bell-on times. This means that outputs of H1, H2, H3 and H4 clocks are on for a period of 1 minute (the shortest duration which can be set for the *Clocks*). The *Clocks* trigger *Timer 1* (time value to be measured, adjustable using the Potentiometer) which in turn sets the Q1 output. Fig. 11.3.2 illustrates the method of “shaping” the bell-on times.

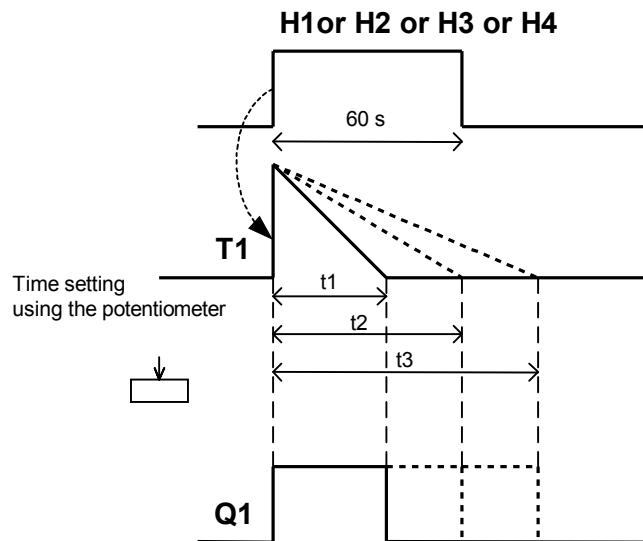

Fig. 11.3.2. Time „shaping” method.

STL

```
O H1          // Enabling H1 or,
O H2          // enabling H2 or,
O H3          // enabling H3 or,
O H4          // enabling H4
L Pot x100ms  //results in triggering T1 Timer in Single Pulse mode
SE T1        //with duration time adjusted with the Potentiometer

//AUTO mode
A I2          //If the AUTO mode is selected the bell operates normally
A T1
=Q1

//Manual mode
A I1          //If the Manual mode is selected the bell responds to
A I3          //I3 button being pressed – turning the bell on
S Q1

A I1          // If the Manual mode is selected the bell responds to
AN I3        // I3 button being depressed – turning the bell off
R Q1
```

LAD

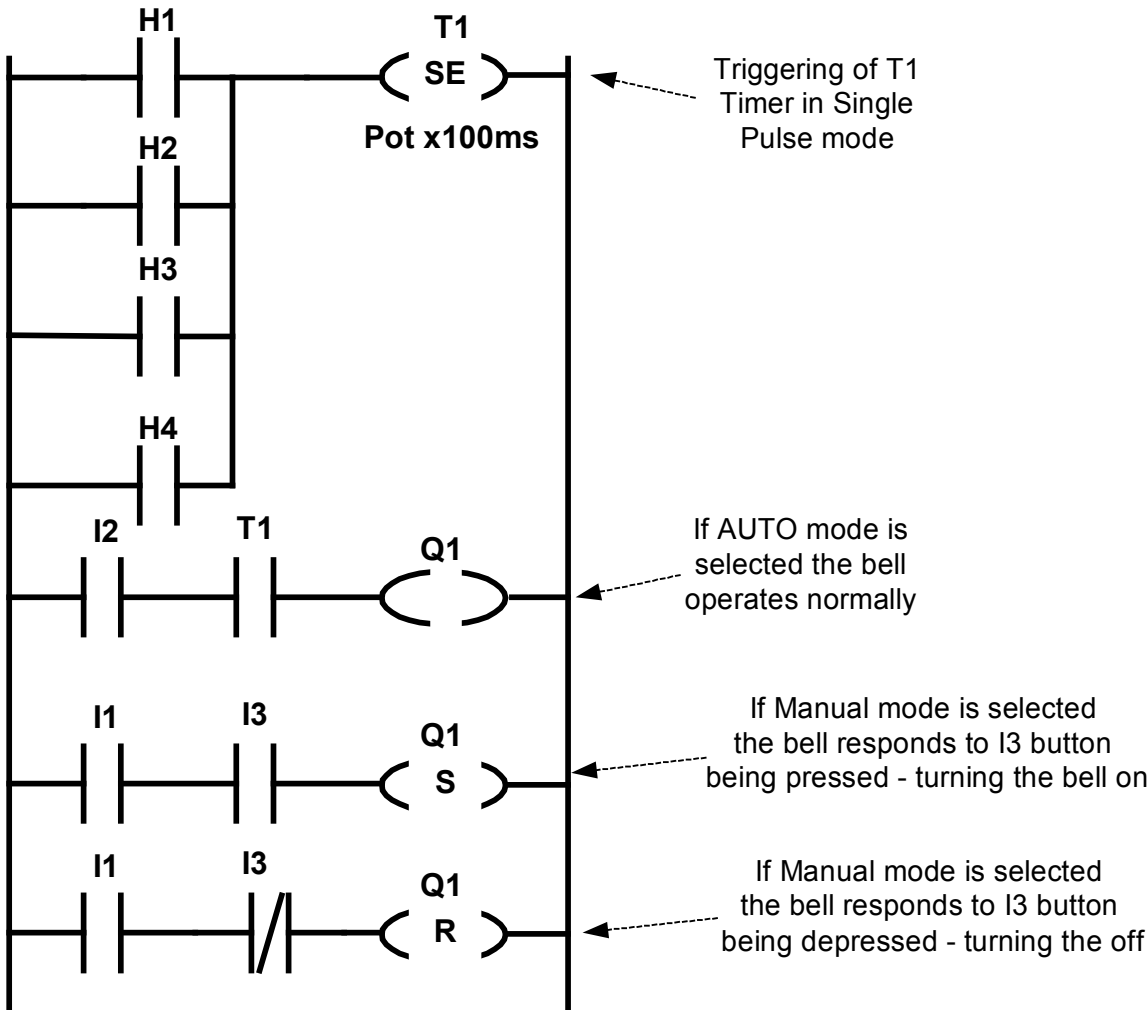

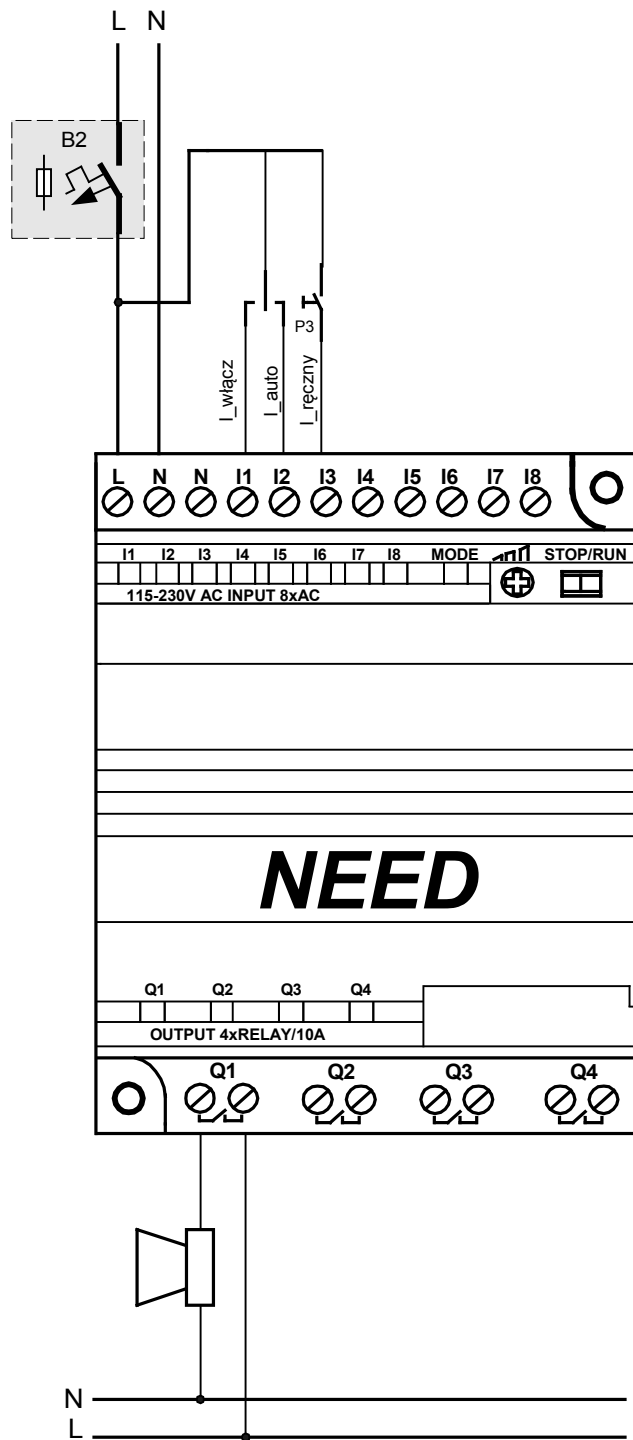

Fig. 11.3.3. Sample electric connection diagram for school bell control.

11.4. Fault detection

The manufacturing process very often requires detection of faulty parts. NEED programmable relay can be used to compose a simple and cheap system to control the quality of the parts manufactured.

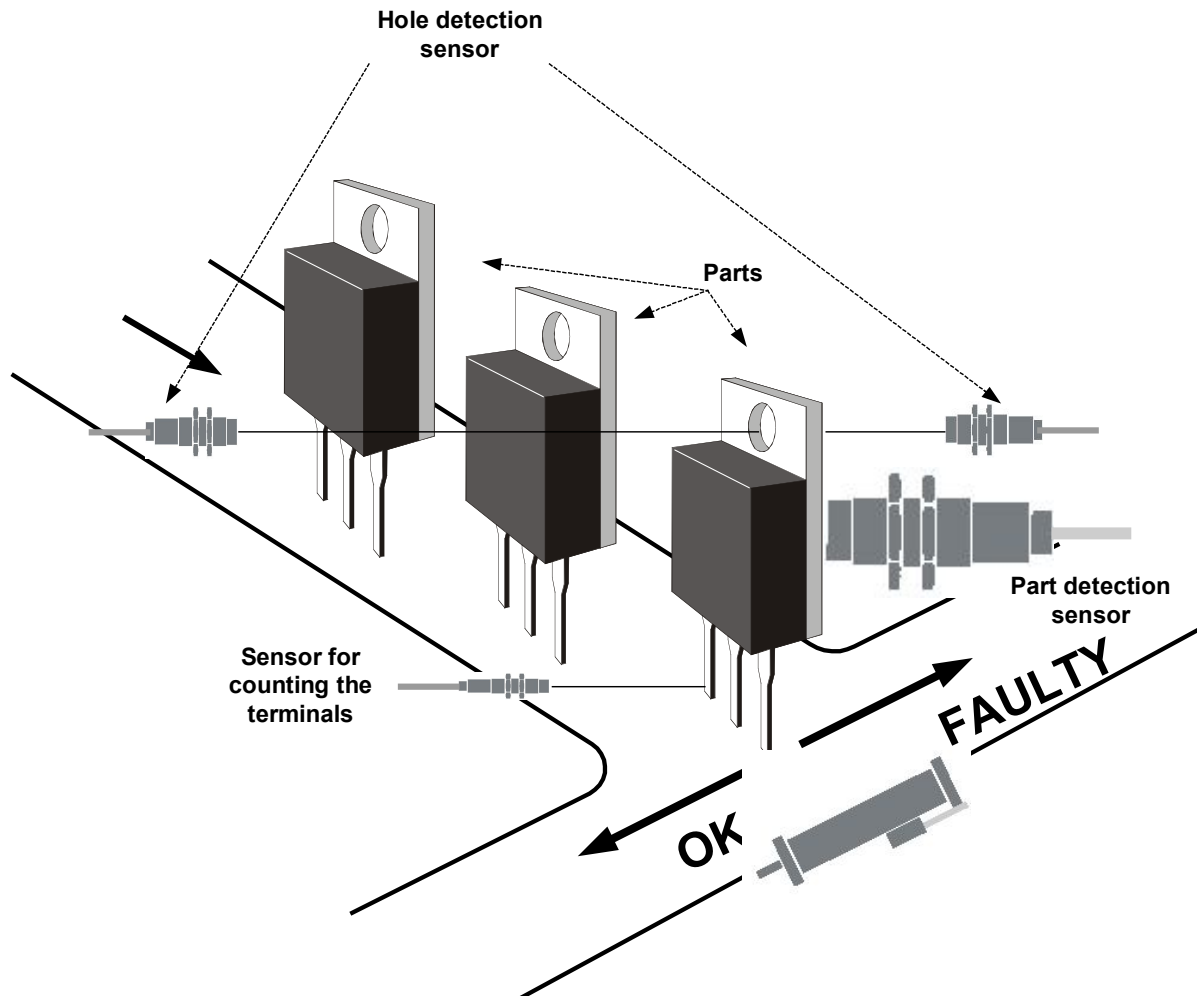

Fig. 11.4.1. Faulty part detection.

Task description

Create a system to enable checking small parts (openings in the transistor housings and the numbers of terminals). Once a faulty part is detected it must be separated from the remaining ones.

Equipment selection:

- 1) To detect the hole a pair of optical sensors (transmitter and receiver) are necessary. The number of transistor terminals can be counted by a laser sensor of small light spot diameter. Also a sensor to detect the transported part can be added as this will greatly simplify our program.
- 2) Separator can be a pulse solenoid valve-controlled cylinder (on sending a control signal to one electromagnet coil the valve remains in its position also after the signal has faded, until a signal is sent to the other coil) on which e.g. mechanical partitions will be installed to deflect the flow of faulty parts
- 3) NEED programmable relay: 3 inputs and 2 outputs.

Algorithm

Occurrence of a part (sensor is enabled) on the transporting line should trigger the sensor for counting the terminals. The hole in the transistor housing should be checked at the same time.

Program:

Equipment configuration:

Address	Inputs	Address	Outputs
I1	Sensor to detect the hole in the transformer housing	Q1	Separator position: <i>OK</i>
I2	Sensor to count the terminals	Q2	Separator position: <i>FAULTY</i>
I3	Sensor to detect the part		

STL

```

A I3          //Part presence detection, saving the state of
= M1          //I3 sensor to M1
R M3          //Resetting the „Part OK” Marker – this allows the partition
              //to remain in place and not to be shifted
              //each time a part occurs

A M1          //Checking the opening (if a part is present)
A I1
S M2

A I2          //Setting C1 Counter to count 3 terminals
L C#3         //of the transistor
CU C1

AN M1         //Checking the presence of the opening and if the three terminals
A M2         //of the transistor have been counted when the part
A C1         //was no longer „seen” by I3 sensor
S M3         //Setting „Part OK” Marker

A M3         //If the transistor is OK the partition is shifted to release
S Q1         //the flow in direction of good parts
R Q2

AN M1         //If the transistor is faulty the partition is shifted to release
AN M3         / the flow in direction of faulty parts
R Q1
S Q2

AN M1         //Resetting auxiliary Markers and C1 Counter
R M2
R C1

```

LAD

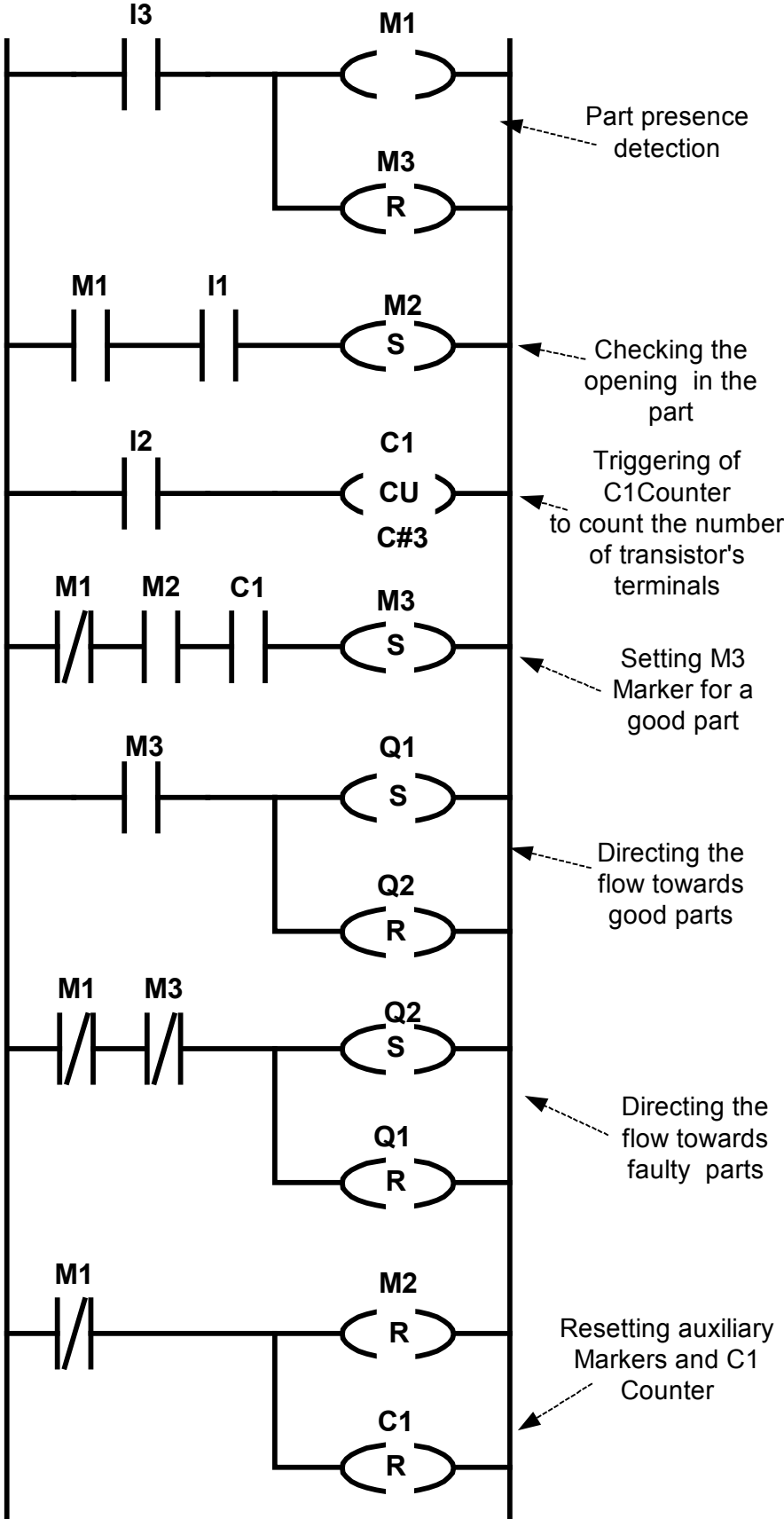

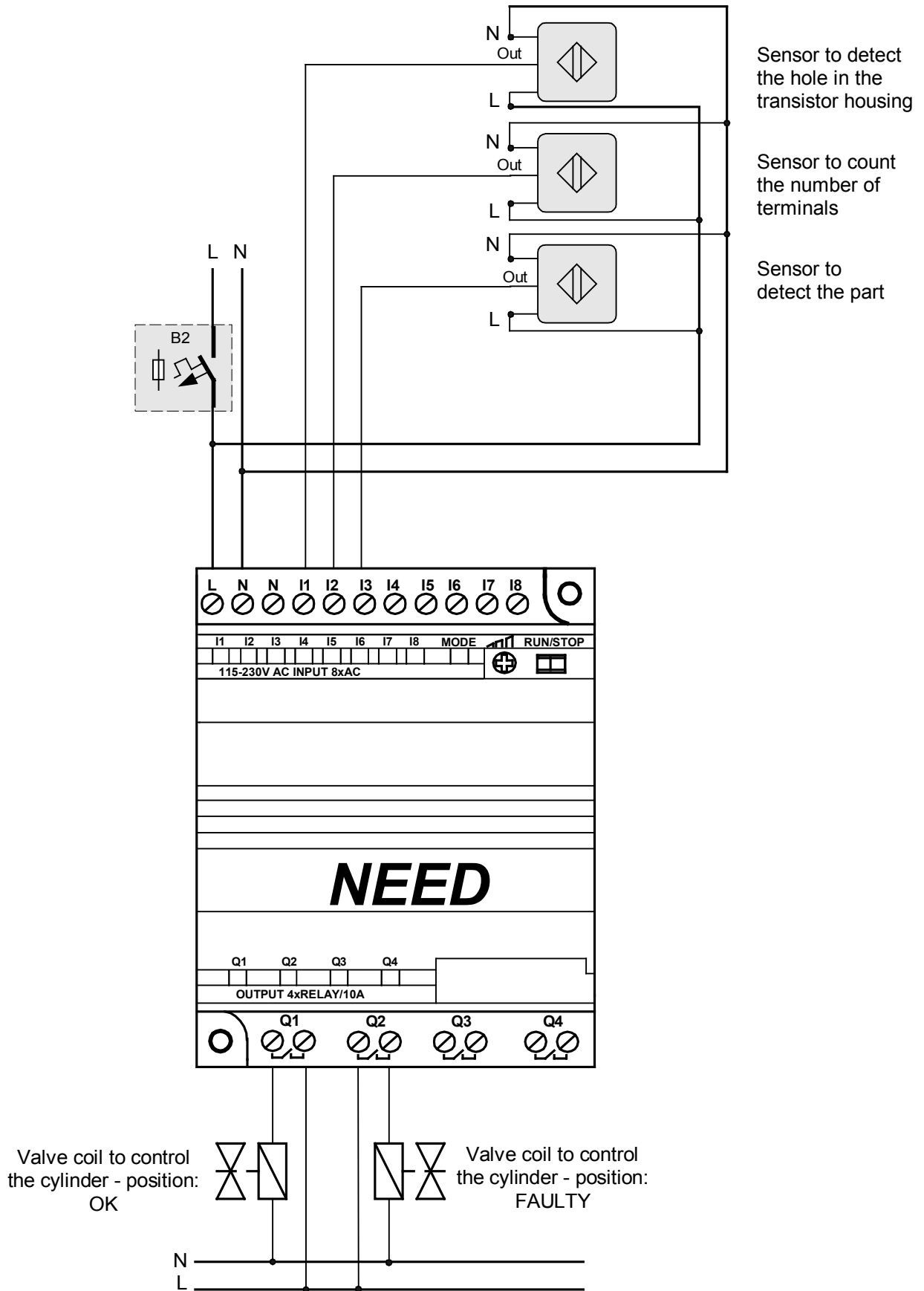

Fig. 11.4.2. Sample electrical connections for fault detection in parts

10.5. Control of the travel of cars in the bend of the belt conveyor

Task description.

Transferring the cars from one side of the belt conveyor to the other one. The operation is performed by a turntable driven by M1 motor.

Only one car can be on the turntable raceway at a time.

Next car cannot be placed on the turntable raceway if the previous one has not left it or the belt conveyor flight is full (cars queuing around the bend).

Additionally, the cars can be removed when in the bend but they have to be returned.

To perform the task several control components will be necessary which are demonstratively presented in Fig. 10.5: sensors (inputs) - I1 and I2, outputs (Q1, Q2 and Q3).

Connect the sensors' outputs to the programmable relay inputs as follows:

I1 input – inductive sensor to detect a car (230V AC PNP)

I2 input - inductive sensor to detect a queue and the transfer of a car to the other side of the belt conveyor (230 V AC PNP).

Q1 output – coil of the solenoid valve which controls the S1 pneumatic cylinder (230V AC).

Q2 output – starting up M1 motor

Q3 output – lamp to signal if the number of cars put on the conveyor is equal to the number of those coming off the conveyor

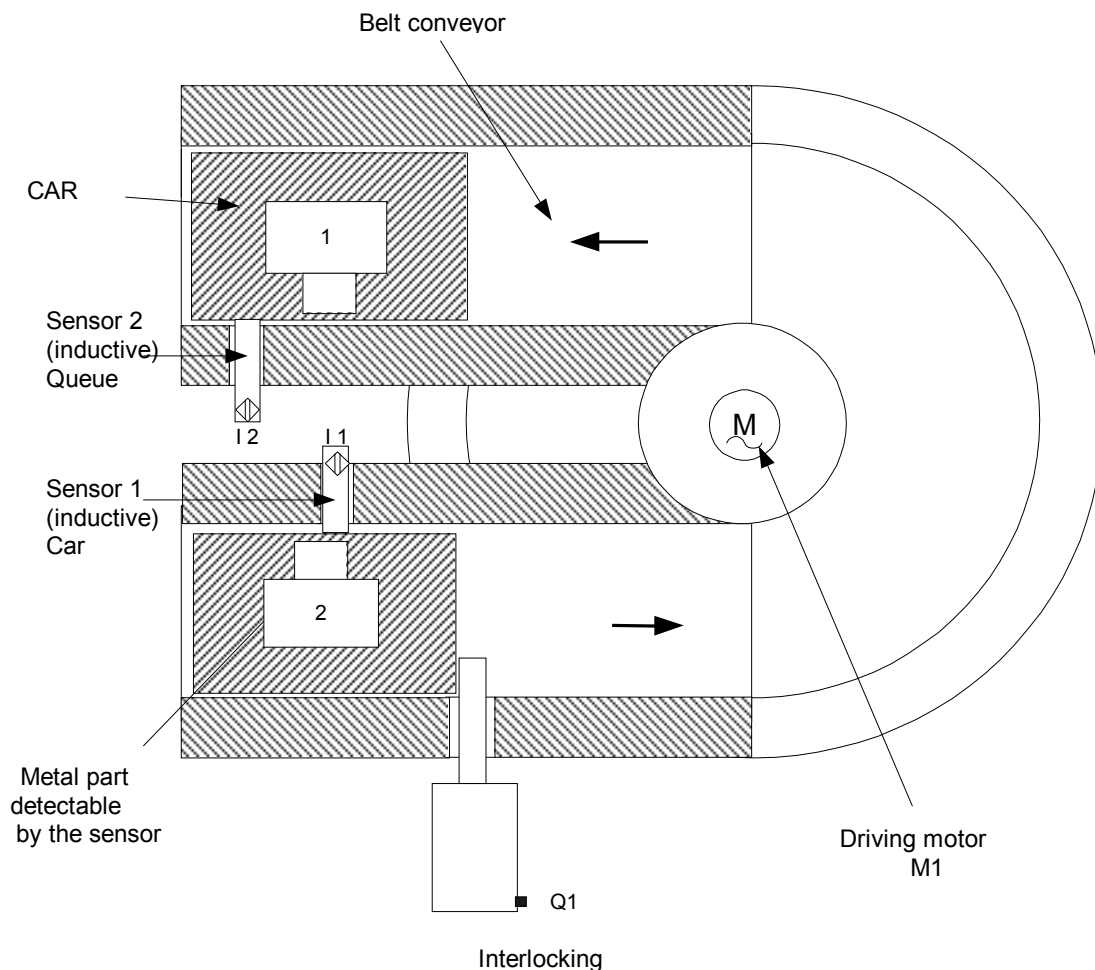

Fig. 10.5.1. Controlling the belt conveyor bend.

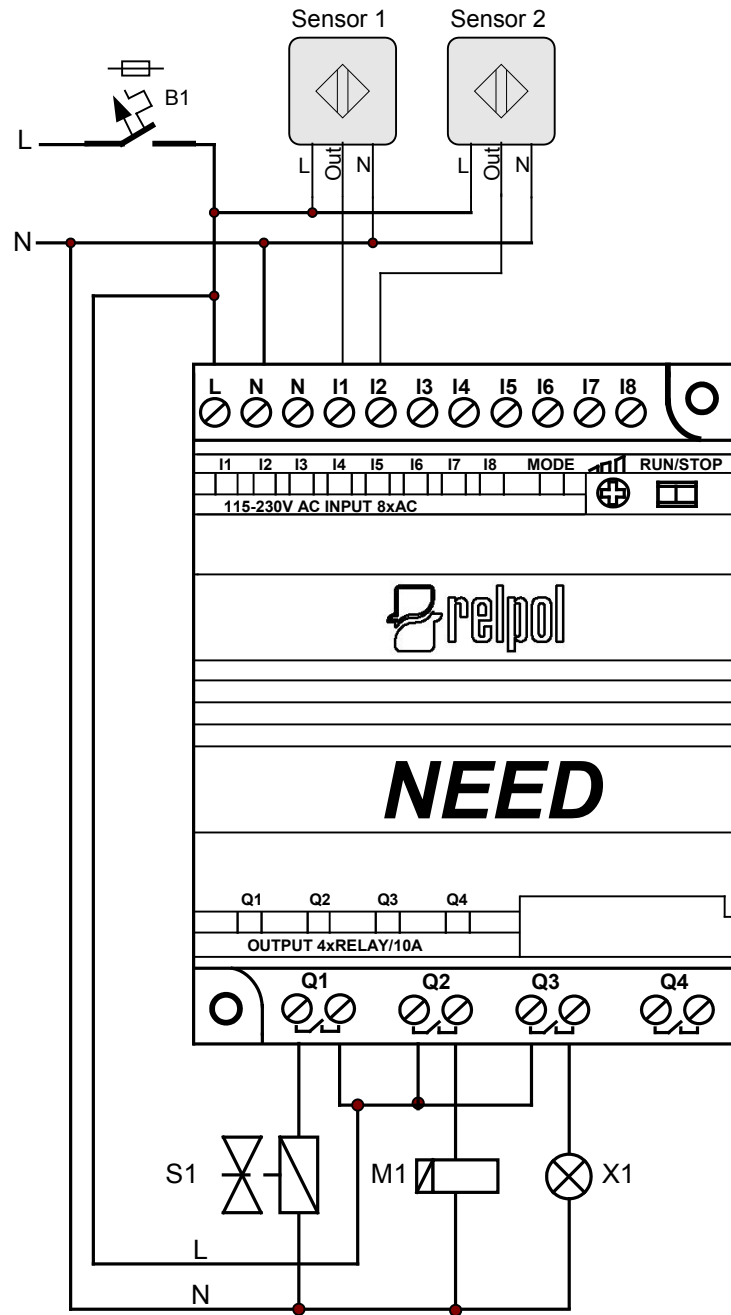
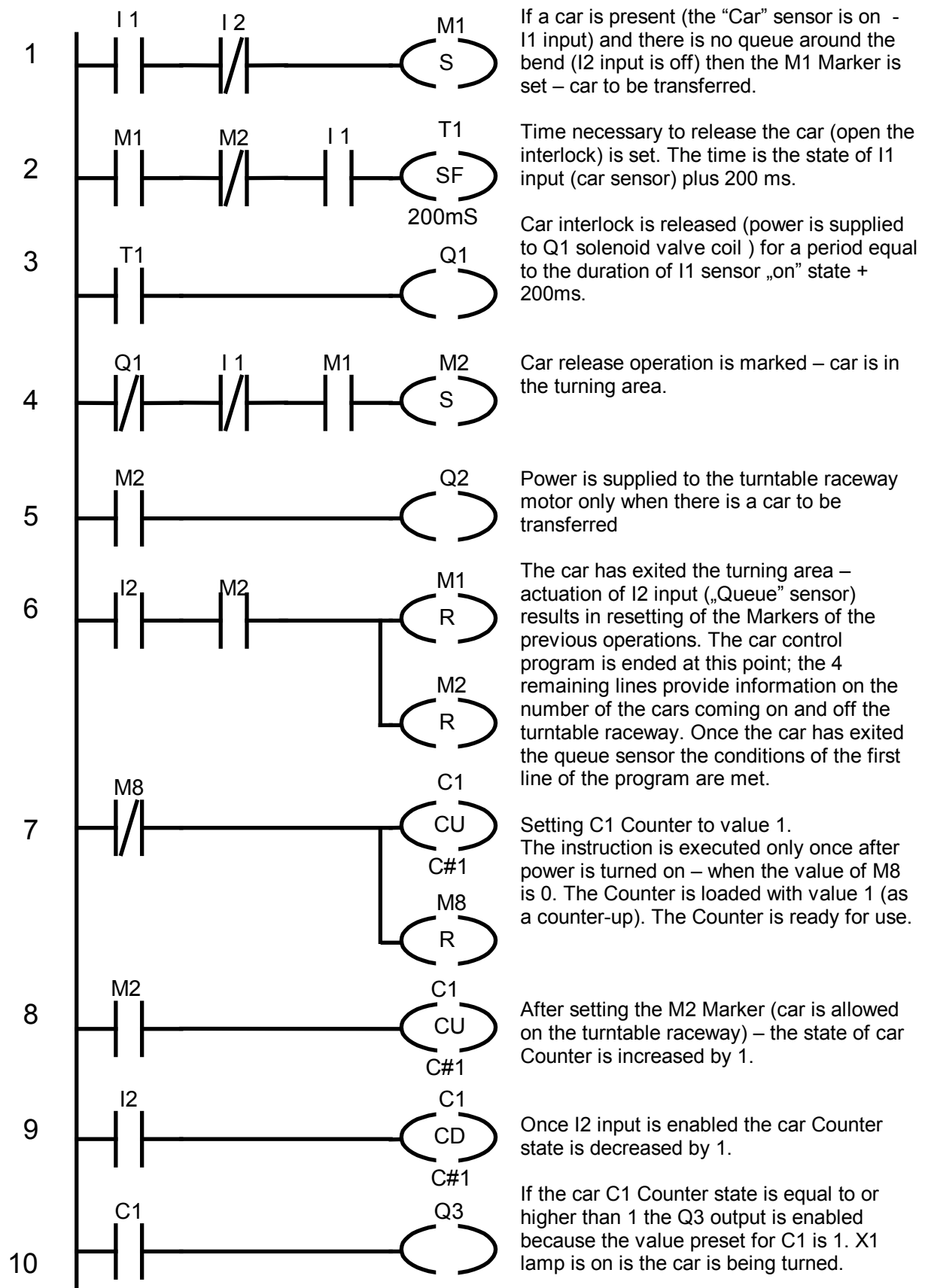

Fig. 10.5.2. Controlling the belt conveyor bend – electrical diagram

Below please find programs written in LAD and STL languages. Numbers in the first column are used to designate individual program loops in order to compare LAD and STL records. They are not parts of the program.

In the normal STL notation spaces between the instructions are not necessary, however they improve the clarity of the program. Additionally, comments can be entered to allow the analysis (tracking) of the program and facilitate later modifications.

LAD program



STL program

1	A I1 AN I2 S M1	If a car is present (the "Car" sensor is on - I1 input) and there is no queue around the bend (I2 input is off) then the M1 Marker is set – car to be transferred.
2	A M1 AN M2 A I1 L 200mS SF T1	Time necessary to release the car (open the interlock) is set. The time is the state of I1 input (car sensor) extended by 200 ms M1 and M2 Markers prevent the Timer to be triggered again if another car appears at I1 sensor (M1) and before the car has left the turning area (M2).
3	A T1 = Q1	Car interlock is released (power is supplied to Q1 solenoid valve coil) for a period equal to the duration of I1 sensor „on” state + 200ms.
4	AN Q1 AN I1 A M1 S M2	Car release operation is marked – car is in the turning area.
5	A M2 = Q2	Power is supplied to the turntable raceway motor only when there is a car to be transferred.
6	A I2 A M2 R M1 R M2	The car has exited the turning area – actuation of I2 input („Queue” sensor) results in resetting of the Markers of the previous operations. The car control program is ended at this point; the 4 remaining lines provide information on the number of the cars coming on and off the turntable raceway. Once the car has exited the queue sensor the conditions of the first line of the program are met..
7	AN M8 L C#1 CU C2 S M8	Setting C2 Counter to value 1. The instruction is executed only once after power is turned on – when the value of M8 is 0. The Counter is loaded with value 1 (as a counter-up). The Counter is ready for use. M8 is set to 1 which ensures that, until the power is off the circuit (6) will have no impact on the program operation.
8	A M2 L C#1 CU C2	After setting the M2 Marker (car is allowed on the turntable raceway) – the state of car Counter is increased by 1.
9	A I2 L C#1 CD C2	Once I2 input is enabled the car Counter state is decreased by 1.
10	A C2 = Q3	If the car C2 Counter state is equal to or higher than 1 the Q3 output is enabled because the value preset for C1 is 1. X1 lamp is on is the car is being turned.

Remarks to the program

The initial situation (before the program in the programmable relay is started) is as follows. The S1 INTERLOCK cylinder (controlled by Q1 solenoid valve) is permanently extended. Once the programmable relay is turned on (START) the states of circuit inputs and outputs are checked. Further, the program instructions are executed line by line, description: see remarks in the table above.

10.6. Lighting and ventilation controller

Task description

The aim of the presented system is to control the lighting of e.g. an office, manufacturing plant, shop etc. It is often the case that, when leaving the house, we forget to switch off the unnecessary lighting or to switch on the so-called night lighting system, necessary for security purposes to protect the facility. Additionally, the signaling LEDs located in the programmable relay provide information on the circuits being on and the operation of the buttons.

The system allows to centrally turn the power on/off (manually or automatically) at preset time or e.g. after turning on/off of an external alarm system.

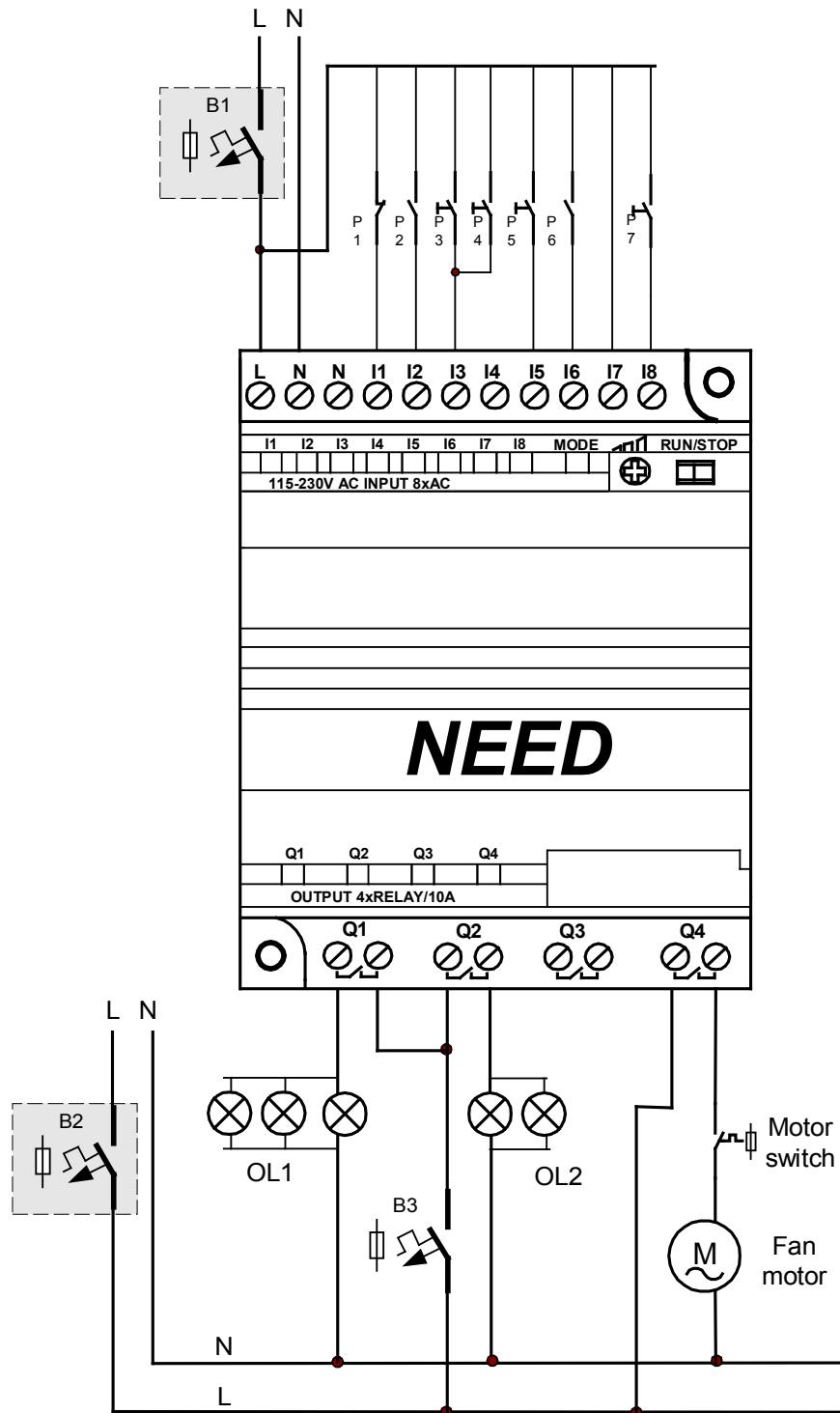

Fig. 10.6.1. Connection diagram

Execution

To switch the system on momentary-on switches will be used i.e. switches which conduct current only when pressed. As they are programmable they can be used in such a way that when pressed for the first time they will turn the circuit on, and the circuit will be turned off once the switches are pressed again. Additional switch (with two stable conditions) allows to change the operating mode from manual to automatic or the other way round. When in manual mode the system does not respond to central switching off.

The use of the programmable relay makes the operation convenient, allows energy savings and provides possibilities to modify the system without changes in the system. The solution presented shows how flexibly any room lighting can be “shaped”.

The system shown in Fig. 10.6. includes the following components:

- P1 – emergency switch contact
- P2 – operating mode switch
- P3, P4 – L1 lamp circuit switches
- P5 – L2 lamp circuit switch
- P6 – alarm system contact (independent alarm system)
- P7 – fan switch (momentary-on type)
- I7 input – supply voltage control
- Q1 – OL1 circuit control
- Q2 – OL2 circuit control
- Q4 – fan motor on-switch

Operation:

Opening of the P1 contact disables all output circuits

P2 open – manual mode, P2 closed – automatic mode

P3 or P4 – first pressing turns the Lamp Circuit 1 on, another pressing turns it off

P5 – the same as P3 and P4 (but for Lamp Circuit 2)

P6 – contact providing the external alarm system arming status

P7 – switching the fan on/off

In manual mode the lighting is switched on/off by the alarm system contact or according to the Clock settings or using P3, P4, P5 buttons.

In manual mode only P3, P4, P5 buttons are operational.

The exhaust fan operates in the preset times.

The figure below illustrates a sample configuration of the Clock set to operate daily from Monday to Friday between 7 a.m. and 3:15 p.m.

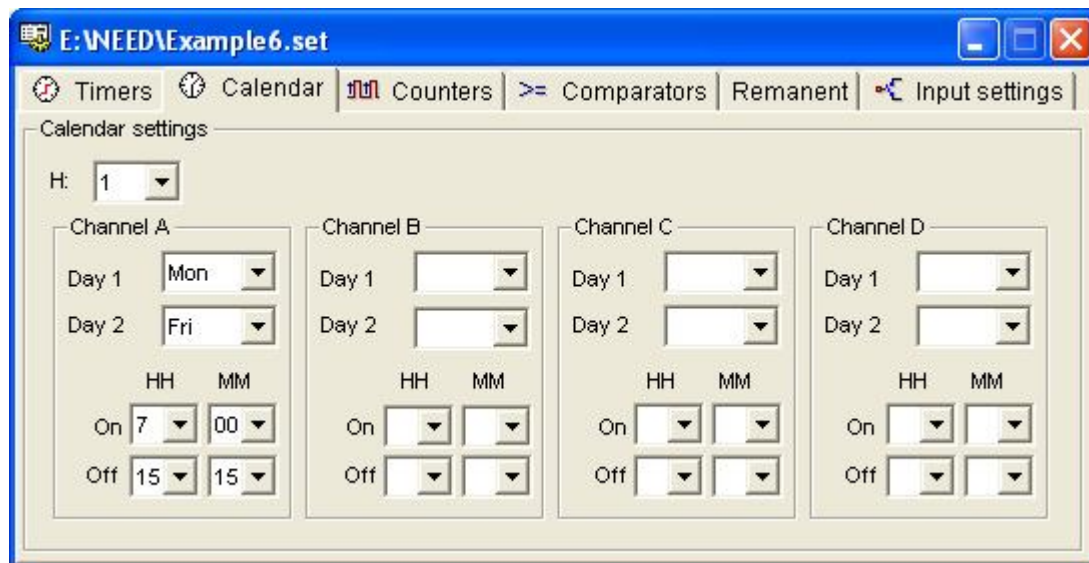
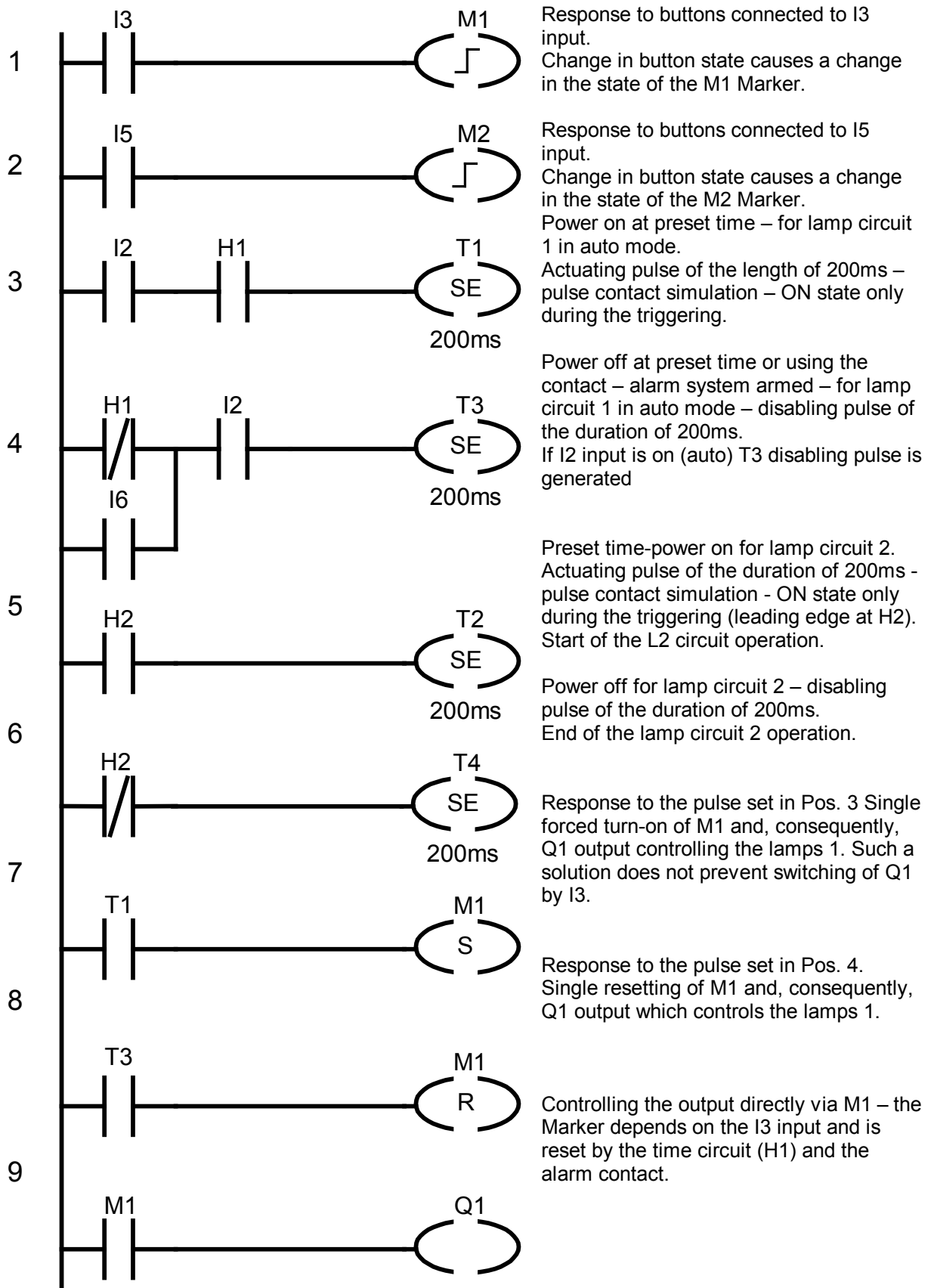
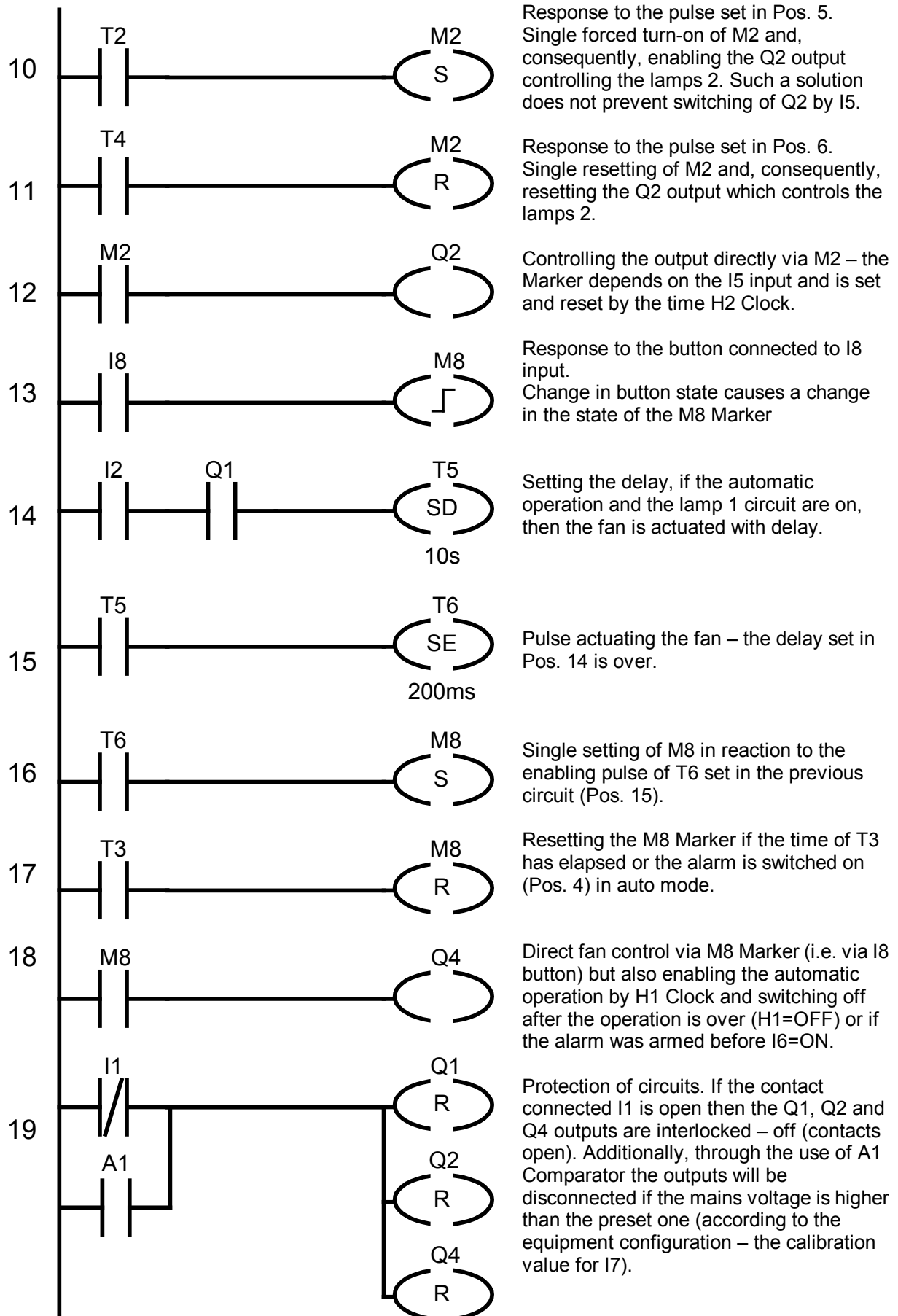

Fig. 10.6.2. Clock configuration

Program in LAD





1	// Turn on/off circuit 1 - buttons A I3 FP M1	Response to buttons connected to I3 input. Change in button state causes a change in the state of the M1 Marker .
2	// Turn on/off circuit 2 - button A I5 FP M2	Response to buttons connected to I5 input. Change in button state causes a change in the state of the M2 Marker.
3	// Auto power on at preset time // Circuit L1 – actuating pulse A I2 A H1 L 200ms SE T1	Power on at preset time – for lamp circuit 1 in auto mode. Actuating pulse of the length of 200ms – pulse contact simulation – ON state only during the triggering.
4	// Power off at preset time or using the //alarm system // L1 circuit in auto mode AN H1 O I6 = M10 A I2 A M10 L 200ms SE T3	Power off at preset time or using the contact – alarm system armed – for lamp circuit 1 in auto mode – disabling pulse of the duration of 200ms. M10 –logical sum of the off time (H1) and I6 – someone armed the alarm system before. If I2 input is on (auto) T3 disabling pulse is generated.
5	// Power on at preset time // L2 circuit - actuating pulse A H2 L 200ms SE T2	Power on at preset time for lamp circuit 2. Actuating pulse of the duration of 200ms - pulse contact simulation - ON state only during the triggering -> H2 = 1. Start of the L2 circuit operation.
6	// Power off at preset time // L2 circuit AN H2 L 200ms SE T4	Power off for lamp circuit 2 – disabling pulse of the duration of 200ms. End of the lamp circuit 2 operation
7	// Circuit 1 power on A T1 S M1	Response to the pulse set in Pos. 3 Single forced turn-on of M1 and, consequently, Q1 output controlling the lamps 1. Such a solution does not prevent switching of Q1 by I3
8	// Circuit 1 power off A T3 R M1	Response to the pulse set in Pos. 4. Single resetting of M1 and, consequently, Q1 output which controls the lamps 1.
9	// Q1 output O M1 = Q1	Controlling the output directly via M1 – the Marker depends on the I3 input and is reset by the H1 Clock and the alarm contact.

10	// Circuit 2 power on A T2 S M2	Response to the pulse set in Pos. 5. Single forced turn-on of M2 and, consequently, enabling the Q2 output which controls the lamps 2. Such a solution does not prevent switching of Q2 by I5
11	// Circuit 2 power off A T4 R M2	Response to the pulse set in Pos. 6. Single resetting of M2 and, consequently, resetting the Q2 output which controls the lamps 2.
12	// Q2 output A M2 = Q2	Controlling the output directly via M2 – the Marker depends on the I5 input and is set and reset by the H2 Clock.
13	// P8 button on // - Fan A I8 FP M8	Response to the button connected to I8 input. Change in button state causes a change in the state of the M8 Marker
14	// Power on - Fan // Setting the delay A I2 A Q1 L 10s SD T5	Setting the delay, if the automatic operation and the lamp 1 circuit are on, then the fan is actuated with delay.
15	// Actuating pulse A T5 I 200ms SE T6	Pulse actuating the fan – the delay set is over.
16	// Fan auto power on A T6 S M8	Single setting of M8 in reaction to the enabling pulse of T6 set above (Pos. 15).
17	// Fan power off // automatically at preset time or using the alarm A T3 R M8	Single resetting of the M8 Marker if the time of H1 has elapsed or the alarm is switched on (Pos. 4) in auto mode
18	// Q4 output A M8 = Q4	Direct fan control via M8 Marker (i.e. via I8 button) but also automatic enabling the operation by H1 Clock and switching off after the operation is over (H1=OFF) or if the alarm was armed before I6=ON
19	// Protection/disabling AN I1 O A1 R Q1 R Q2 R Q4	Protection of circuits. If the contact connected to I1 input is open then the Q1, Q2 and Q4 outputs are interlocked – off (contacts open). Additionally, through the use of A1 Comparator the outputs will be disconnected if the mains voltage is higher than the preset one (according to the equipment configuration – the calibration value for I7).

Remarks to the program

The example above is only one of the possible uses of the NEED programmable relay which is to show the application of various instructions e.g. the FP function allows the natural use of momentary-on switches as light switches.

The use of the internal clock provides a number of possibilities to control the circuits in a time-based manner. The use of the analogue input allows to protect the controlled circuits against the effects of wrong supply voltages (provided that the executive circuits are supplied from the same phase as the power supply of the programmable relay).

10.7. Load control

Task description

By taking advantage of the analogue input capabilities it is possible to quite precisely control the power consumed by a load and provide adequate response once the consumption level is exceeded e.g. cutting off the load from the power source. It gives a possibility to easily supplement the control system of e.g. a staircase lighting, with a feature which allows the protection of the system from uncontrolled power consumption (theft). Additionally, if so composed the power consumption limiter cannot be set to a higher power consumption level without software modifications.

The presented program can constitute a part of a comprehensive staircase or corridor lighting solution; the following components can be connected to the spare inputs: button switches, external door opening sensor, electromagnet lock opening signal transmitted via door entry system network. Additionally, through the use of the integrated clock/calendar some features can be made dependent on the time of the day or the day of the week.

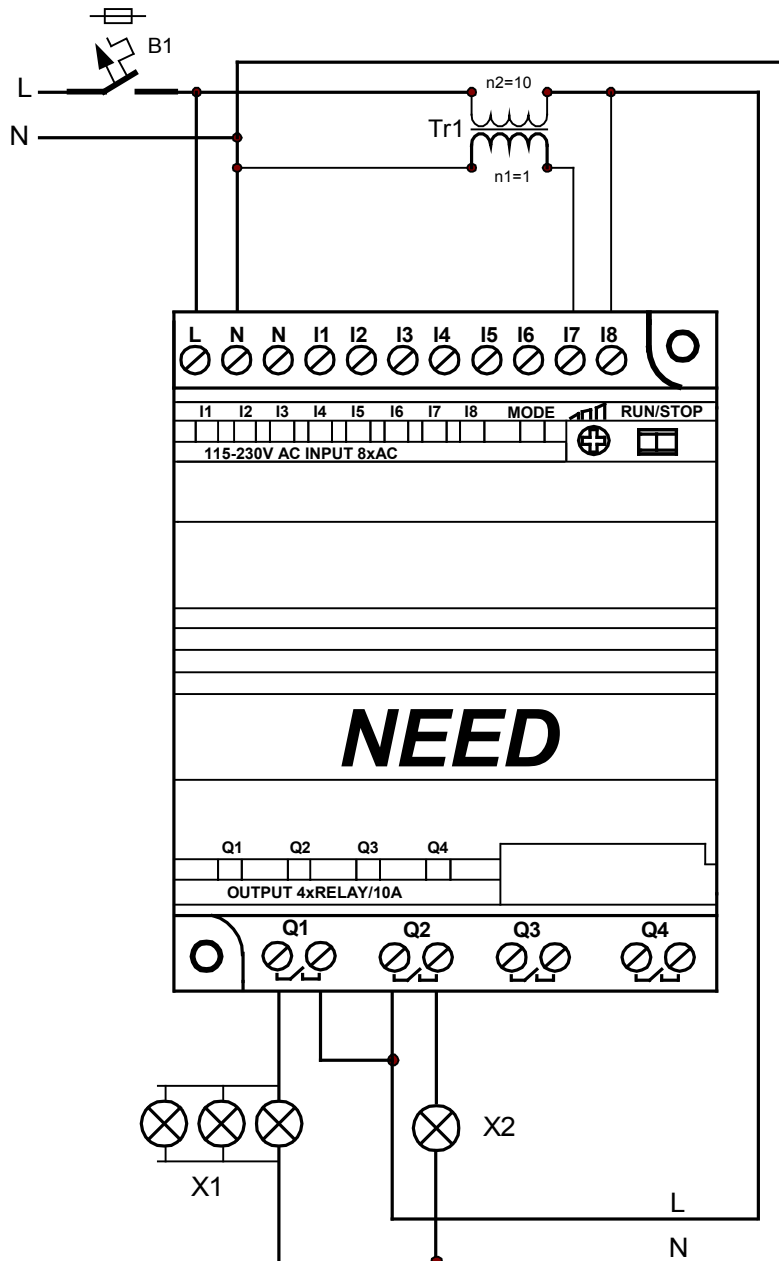

Fig. 10.7. Electric connection diagram.

For simplification purposes let's assume that an additional current transformer component will be used to convert the main circuit current to a proportional voltage. The higher the power consumption the higher the voltage on the secondary side. Bearing in mind the equipment limitations we know that the power of up to 2300W can be controlled ($I=10A$, $U_z=230V$ AC).

If assumed that the current of 10A corresponds to the voltage of 100V in the secondary winding, the current of e.g. 5A can be set by entering the value of 50 as standard value. The built-in Potentiometer can be used instead to be set manually to the desired value. Q1 output can be controlled according to the current consumed through the use of the A2 analogue Comparator feature ($I7 \geq$ standard value). Once the set level is exceeded ($I7 \geq 50V$) the output disconnects the load which is signaled by Q2 output. Re-actuation can be done after 10 seconds from the cut-off (the time is adjustable).

STL program

1	AN M5 L 2S SE T1 S M5	Relay power on. Input function of the time necessary for load stabilization (T1 Timer – 2 seconds), M5 Marker means a program start.
2	AN T1 A M5 A A2 = M2	M2 Marker is set if the time necessary for the first enabling of the load has elapsed and the load current is not exceeded ($A2 = '1'$).
3	A A2 L 10s	Locking time for the output if the allowed current level has been exceeded.
4	SF T2 AN T1 A M2 AN T2 = Q1	Controlling the output which enables the load. The output is on after 2 seconds from the power-on (T1) or depending on the M2 Marker (current control). The output is locked by the time delay enabling (T2) once the A2 comparison condition is exceeded (current value exceeded).
5	AN Q1 R M5	Output is off – the control program starts from the beginning.
6	A T2 AN Q1 = Q2	Signal output – on, if the load is disconnected.
7	A I1 L 30s SE T5	Additional "automatic step system" – setting the on-time at 30 seconds.
8	A T5 = Q4	Additional "automatic step system" – lamp control by Q4.

Remark to the program:

Please note that the M5 Marker cannot be set as remanent in the configuration –its state should not be "remembered" after power-on.

LAD program

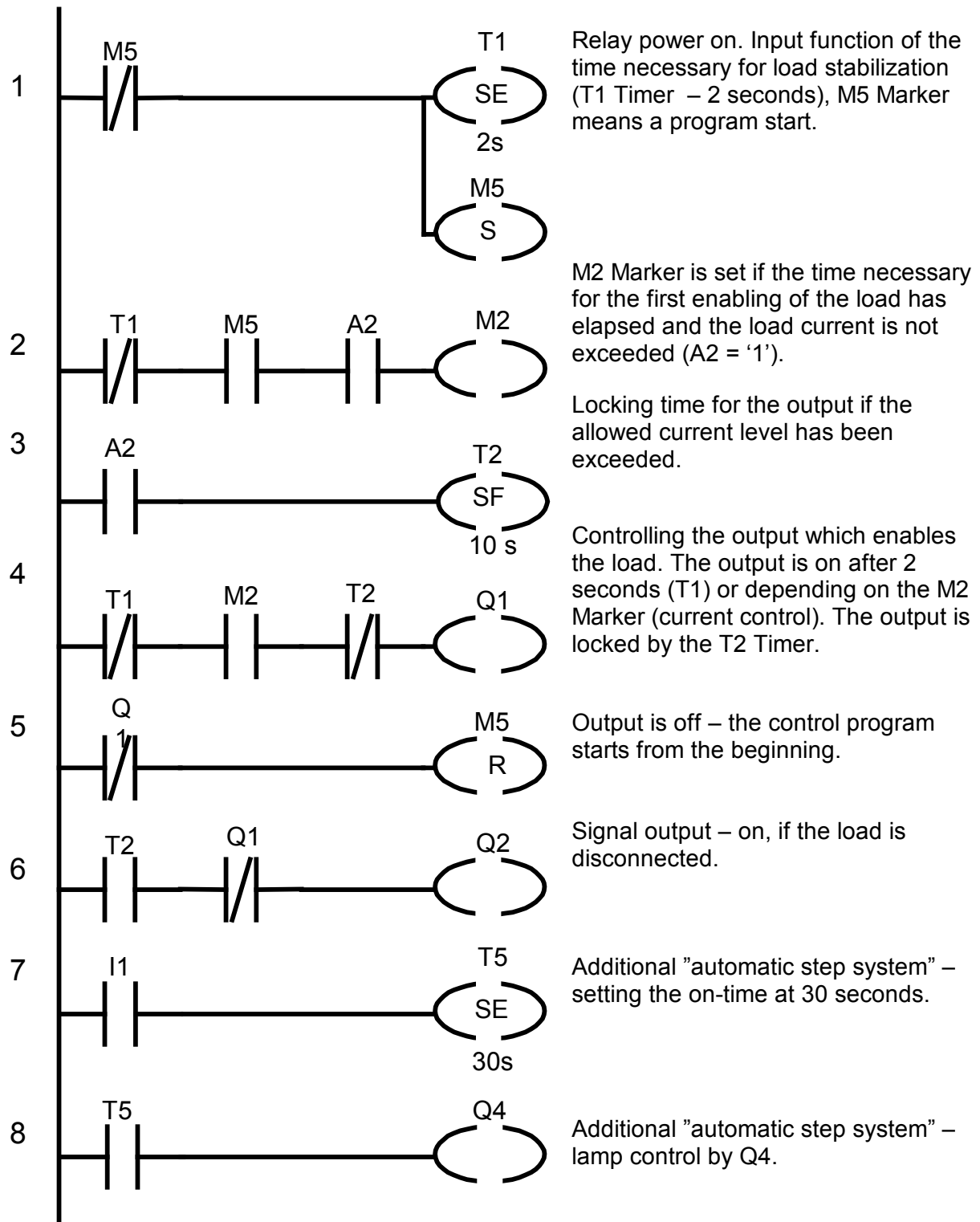

Remarks to the program

Circuits 1..6 refer to the diagram presented in Fig. 10.7. Circuits 7 and 8 show further application possibilities for spare inputs/outputs in arrangement of a simple system to time-control a staircase lighting.

10.8. Three-phase motor control and protection

Task description

The purpose of the presented system is to control a motor and monitor the parameters of the power supply network for a low power 3-phase motor. By using the NEED 230AC-x1-16-8 relay we can handle starting/cutting-off the 3-phase motor, control the power supply parameters and if required switch over to backup power supply without any additional components.

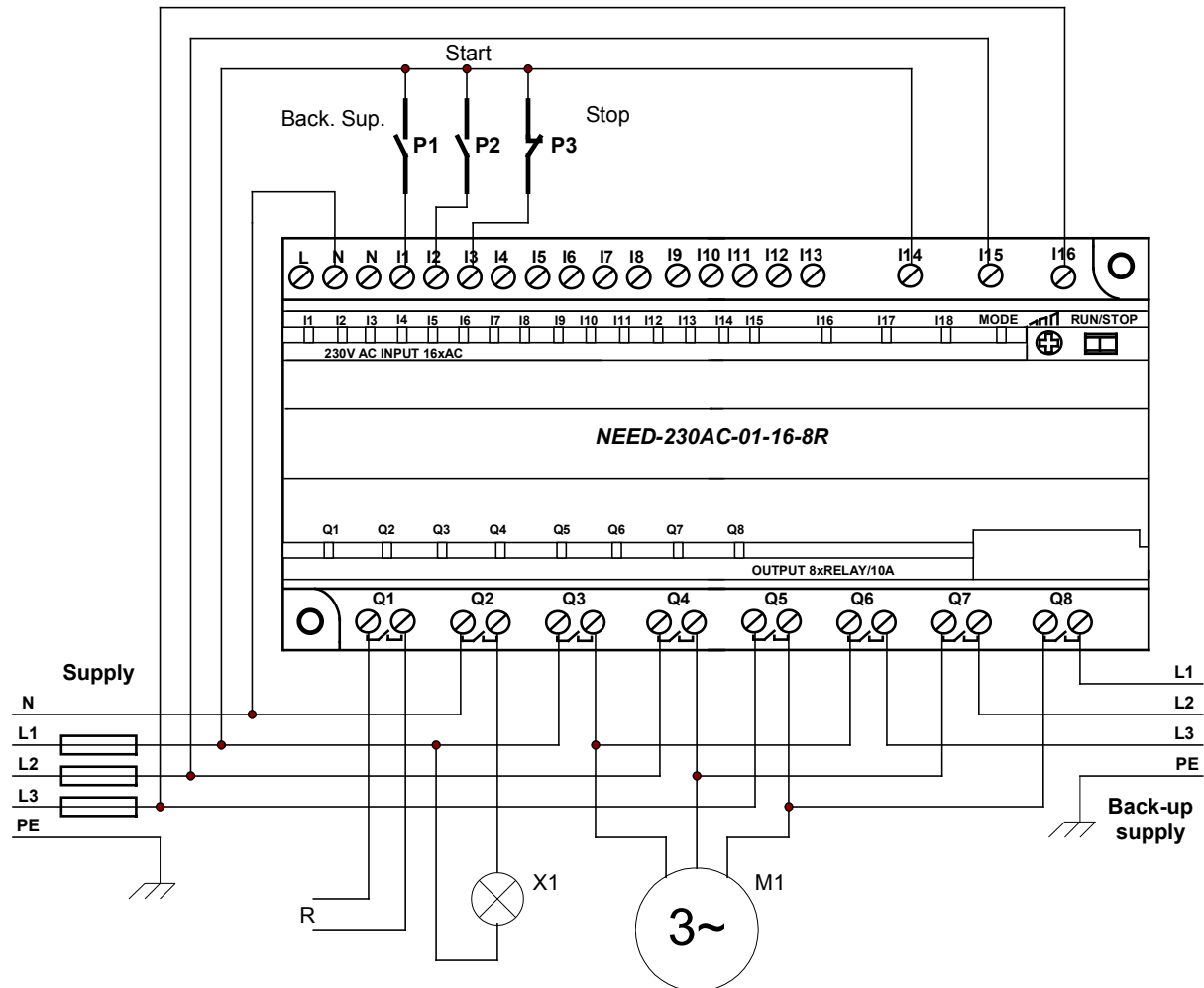

Fig. 10.8.1. Electrical connections diagram.

The motor is started/cut-off with the START / STOP buttons. The “Backup power” switch makes it possible to choose the mode of operation:

- switched off – in the event of a power supply network problem the motor will be cut off.
- switched on - in the event of a power supply network problem the motor will continue to run on backup power supply and will automatically revert to the main power, if the power supply parameters are within the required limits.

the relay’s built in functionality makes it possible to implement a power supply network monitoring relay, satisfying the following functionalities:

- a) Monitoring of voltage levels of individual phases (minimum - U_{min} and maximum power supply voltage - U_{max})
- b) Phase sequence monitoring
- c) Phase loss monitoring
- d) Asymmetry monitoring – U_{asym}

The aforementioned parameters can be freely configured in the program settings. You can set the minimum and maximum voltage separately for each phase, as well as the minimum and maximum asymmetry level. Modifying the program we can give up the monitoring of selected parameters, it is not essential for the controlled system.

The STL program

The program is comprised of three parts:

1. Definition of relay type
2. Definition of symbolic names
3. Control program (Source code)

```
// Relay type
1 .DEVICE="230AC-X1-16-8"

2 // Symbolic variables
.DEFINE A1_L1min=A1
.DEFINE A2_L2min=A2
.DEFINE A3_L3min=A3
.DEFINE A4_L1max=A4
.DEFINE A5_L2max=A5
.DEFINE A6_L3max=A6
.DEFINE A7_Asym=A7
.DEFINE A8_Asym=A8
.DEFINE I1_Zal_rez=I1
.DEFINE I2_START=I2
.DEFINE I3_STOP=I3
.DEFINE M1_Umin=M1
.DEFINE M2_Umax=M2
.DEFINE M3_Uzas=M3
.DEFINE M4_Asym=M4
.DEFINE M5_Zas_OK=M5
.DEFINE M6_ZALACZ=M6
.DEFINE Q1_R=Q1
.DEFINE Q2_Sygn=Q2
.DEFINE Q3_L1=Q3
.DEFINE Q4_L2=Q4
.DEFINE Q5_L3=Q5
.DEFINE Q6_L1rez=Q6
.DEFINE Q7_L2rez=Q7
.DEFINE Q8_L3rez=Q8
.DEFINE T1_Opozn=T1
.DEFINE T2_sygn=T2

// Program
3 A %A1_L1min
A %A2_L2min
A %A3_L3min
= %M1_Umin

A %A4_L1max
A %A5_L2max
A %A6_L3max
= %M2_Umax

A %M1_Umin
A %M2_Umax
= %M3_Uzas
```

The M1 marker is set, when the voltage of each phase is higher than Umin.

The M2 marker is set, when the voltage of each phase is lower than Umax.

The M3 marker is set, if the phase voltages are within set limits.

3	<pre> A %A7_Asym A %A8_Asym = %M4_Asym A %M3_Uzas A %M4_Asym A MDIR SD %T1_Opozni // 1.00s A %T1_Opozni = %M5_Zas_OK A %I2_START A %M5_Zas_OK S %M6_ZALACZ A(ON %I3_STOP O(AN %I1_Zal_rez AN %M5_Zas_OK)) R %M6_ZALACZ A %M5_Zas_OK = %Q1_R A %M6_ZALACZ A %M5_Zas_OK A %I3_STOP = %Q3_L1 = %Q4_L2 = %Q5_L3 A(O %I1_Zal_rez ON %M5_Zas_OK) AN %M5_Zas_OK A %M6_ZALACZ = %Q6_L1rez = %Q7_L2rez = %Q8_L3rez SL %T2_sygn // 0.50s A %T2_sygn = %Q2_Sygn </pre>	<p>The M4 marker is set if the asymmetry voltage does not exceed U_{asym}.</p> <p>The T1 timer is started if phase voltages, asymmetry and sequence are correct</p> <p>The M5 marker is set, if the controlled parameters are stable during a predefined delay time.</p> <p>The M6 marker is set after the START button, if the power supply parameters are correct. It is cleared by the STOP button or if the power supply parameters are incorrect and backup power supply is not enabled.</p> <p>Q1 output – on, if power supply parameters are correct</p> <p>Motor start on. Q3, Q4, Q5 outputs – switching on phases L1, L2, L3 respectively to the motor</p> <p>Failover to backup power supply. Q6, Q7, Q8 outputs – enabling backup power supply (phases L1rez, L2rez, L3rez respectively) to the motor. The T2 timer in SL mode generates pulses for the Q2 output</p> <p>Q2 output - backup power on signal - toggles on/off 0.5s/0.5s.</p>
---	---------------------------------------------------------------------------------------------------------------------------------------------------------------------------------------------------------------------------------------------------------------------------------------------------------------------------------------------------------------------------------------------------------------------------------------------------------------------------------------------	------------------------------------------------------------------------------------------------------------------------------------------------------------------------------------------------------------------------------------------------------------------------------------------------------------------------------------------------------------------------------------------------------------------------------------------------------------------------------------------------------------------------------------------------------------------------------------------------------------------------------------------------------------------------------------------------------------------------------------------------------------------------------------------------------------------------------------------------------------------------------------------------------------------------------------------------------------------------------

The LAD program

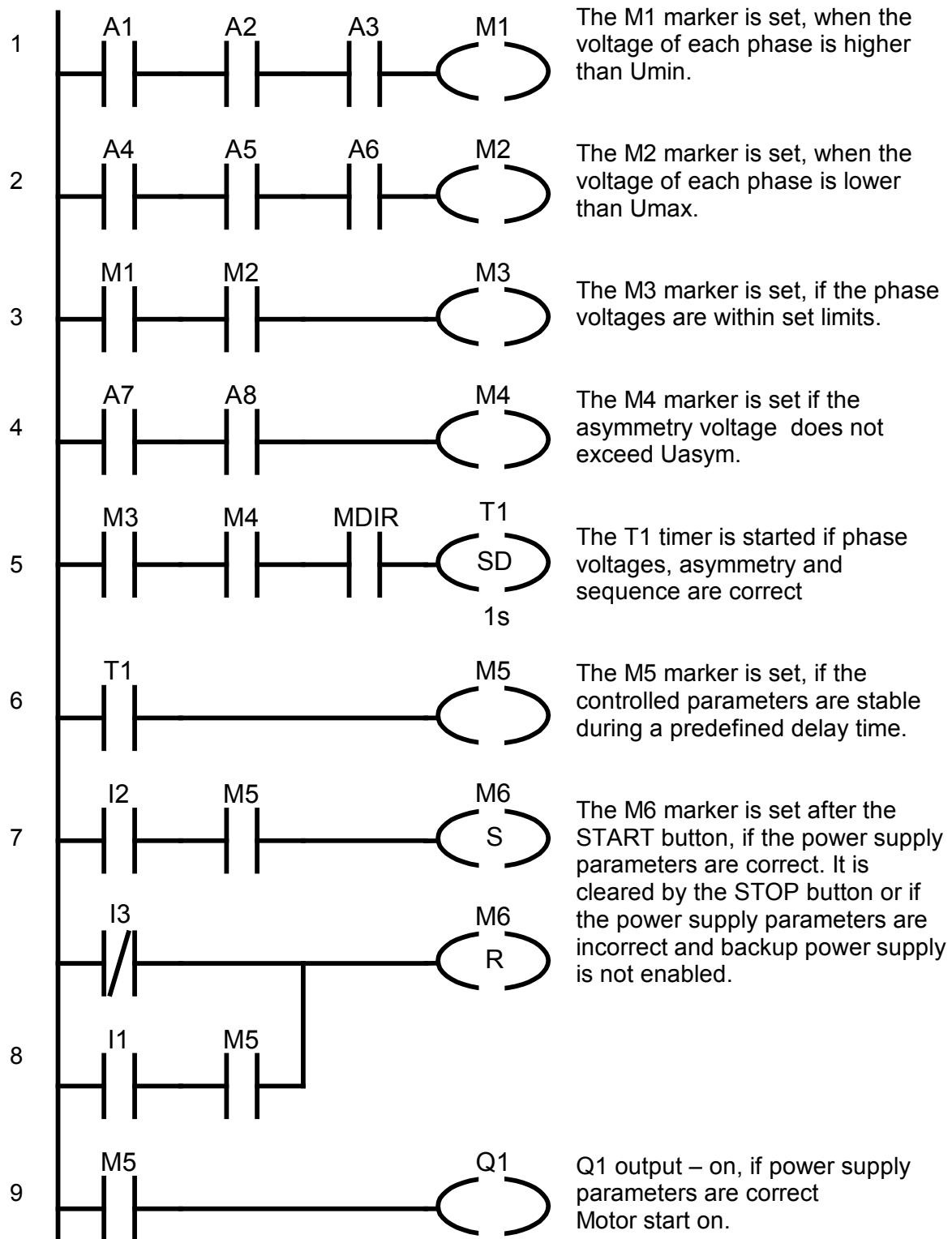

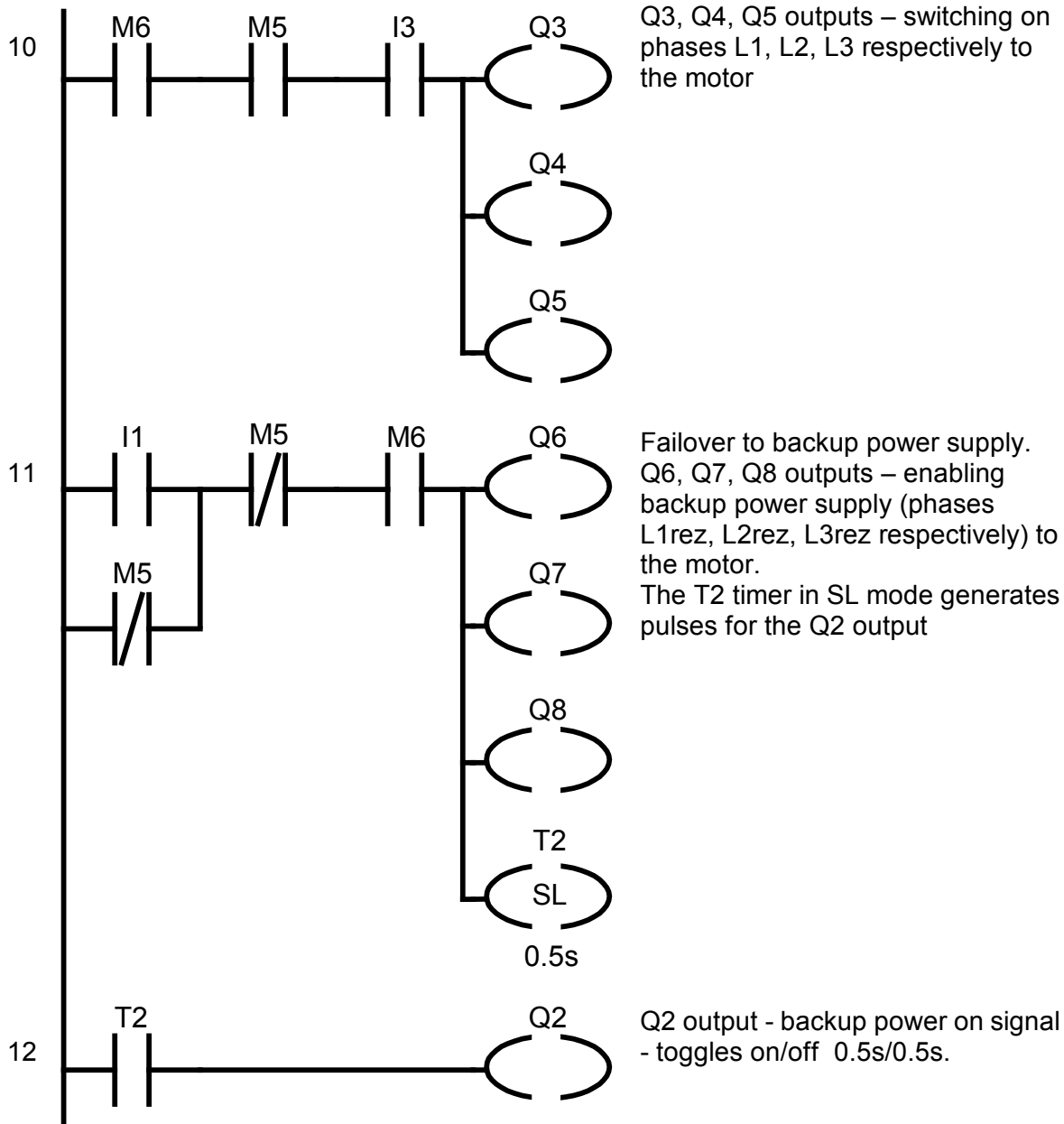

The LAD program may also use symbol names (similar to STL). If the symbols are assigned to the registers and the view is switched to the symbol names, then the symbol name will be visible instead of the register name. Below is an example for the first line.

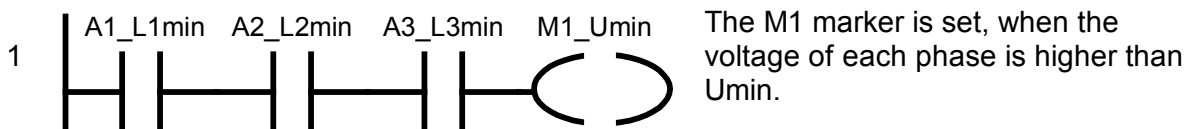

Settings

The parameters of the power supply network are controlled through the I14, I15, I16 analog inputs.

The minimum U_{min} and maximum U_{max} voltages for each phase are set in A1..A6 comparators, respectively:

A1: AI14 \geq 200V

A2: AI15 \geq 200V

A3: AI16 \geq 200V

A4: AI14 \leq 240V

A5: AI14 \leq 240V

A6: AI14 \leq 240V

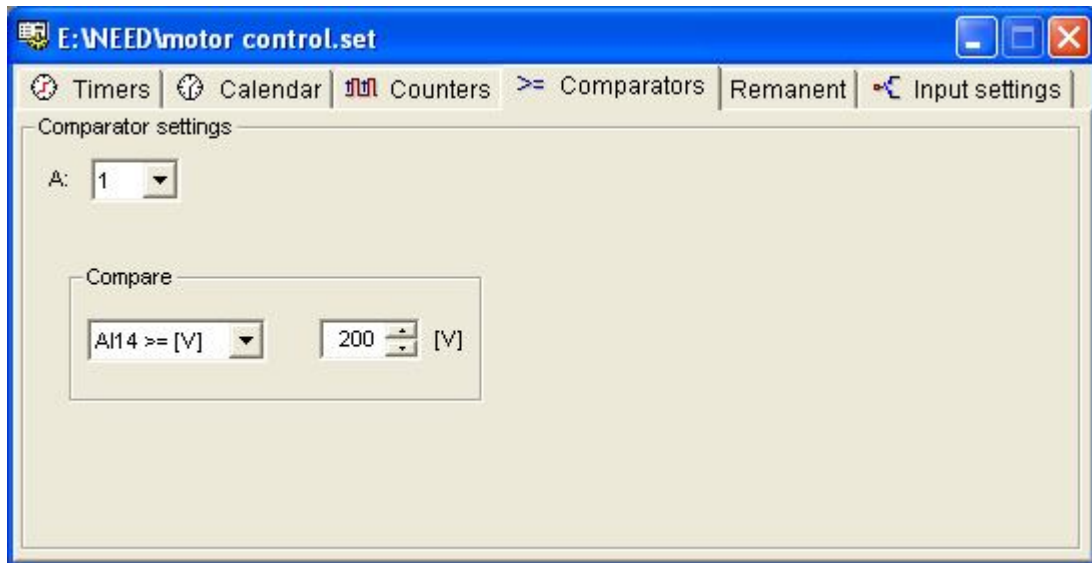

Fig. 10.8.1. The comparator settings.

For all phases the minimum voltage is set as 200 V and the maximum voltage as 240V. They are, of course, freely configurable.

The A7 and A8 comparators are used for setting the minimum and maximum asymmetry voltage, 0..10V.

A7: ASYM \geq 0V

A8: ASYM \leq 10V

Additionally you can set the delay time of the T1 timer, i.e. the minimum time of stability of correct network parameters and the T2 signaling pulses time.

12. TECHNICAL SPECIFICATIONS

General data

Relay description NEED-...08-4R NEED-24DC-...08-4T	6 AC digital inputs 2 analog- digital inputs 4R – NO digital relay outputs 4T – NO digital transistor outputs Real time clock,
NEED-...x1-16-8R NEED-24DC-...16-8T	13 AC digital inputs 3 analog- digital inputs 8R – NO digital relay outputs 8T – NO digital transistor outputs Real time clock, Fast counter Three phase network control
Possibility to add LCD display with keyboard module NEED-...x1-.. NEED-...22-..	No Yes
Use	In LV systems
Supply voltage NEED-230AC-.. NEED-220DC-.. NEED-24DC-.. NEED-12DC-..	95V ÷ 260V AC, 50Hz/60Hz 154V – 242V DC 19.6V ÷ 28.8V DC 10.2V ÷ 14.4V DC
Installation: Location Mounting Operating location	Any On a 35mm wide mounting bar or 2 screws Ø 4mm In a control cabinet, system switchgear conforming with EN 61131-2
Installation	The device can be mounted only by a person qualified in fitting electrical systems
Connecting wires	1×2.5mm ² 2×1mm ²
Maximum tightening torque of the connection terminals	0.6Nm
Standards conformity	PN-EN 61131-2
Certificates	CE, B UL, VDE, GOST
Size: NEED-...08-4: Width Length Height Weight max. NEED-...x1-08-4 NEED-...22-08-4-D	72mm 90mm 55mm 210g 250g

NEED...-16-8:	
Width	132mm
Length	90mm
Height	55mm
Weight max.	
NEED...-11-16-8	370g
NEED...-22-16-8	413g

Environment and mechanical conditions and requirements

Operating temperature	From -20°C to +55°C
Relative humidity	10-95% non condensing
Atmospheric pressure	795hPa up to 1080hPa
Contamination level	2
Vibrations allowed in operating conditions (PN-EN 60068-2-6)	5Hz to 9Hz (fixed amplitude of 3.5mm) 9Hz to 150Hz (fixed acceleration of 1g)
Shocks (PN-EN 60068-2-27)	6 shocks (half-sinusoid 15g/11ms)
Flat and supported drop (PN-EN 60068-2-31)	100mm, 2 tests 30°, 2 tests
Storage transportation temperature	-40°C to +70°C
Free fall (PN-EN 60068-2-32): product in transportation packaging product in sale packaging	1000mm 300mm

Safety requirements

Rated insulation resistance	300V AC
Rated surge voltage	2 500V
Overtoltage category	Class II
Enclosure protection class (PN-EN 60529)	IP 20
Fire rating (UL94)	V0

EMC Requirements

Radiated interference emission (EN 55011) NEED..-x1-08-4	Boundary value class A, group 1
NEED..-x1-16-8	Boundary value class B, group 1
Conducted interference emission (EN 55011) NEED..-x1-08-4	Boundary value class A, group 1
NEED..-x1-16-8	Boundary value class B, group 1
Resistance to electrostatic discharge (EN 61000-4-2)	8kV – airborne discharge, 4kV – surface discharge,
Susceptibility to radio frequency electromagnetic fields (EN 61000-4-3)	10V/m, 80MHz – 1 000MHz 800MHz – 960MHz 1.4GHz – 2.0GHz
A series of fast electrical transient states (EN 61000-4-4): NEED-230AC-x1-..	2kV – power leads 2kV – signal wires
NEED-220DC-x1..., NEED-24DC-x1..., NEED-12DC-x1-..	2kV – power leads 1kV – signal wires
High energy surge (EN 61000-4-5): NEED-230AC-x1-.. power supply port	2kV – asymmetric signal 1kV – symmetric signal
input circuit ports	2kV – asymmetric signal 1kV – symmetric signal
NEED-220DC-x1..., NEED-24DC-x1-..., NEED-12DC-x1-.. power supply port	1kV – asymmetric signal 0.5kV – symmetric signal
input circuit ports (unshielded lines)	0.5kV – asymmetric signal 0.5kV – symmetric signal
Resistance to radio frequency interference	3V 26 – 80MHz

Power supply circuit

Power supply voltage: NEED-230AC-.. rated value operating range	115V / 230V AC, 60Hz/50Hz 95V – 260V
NEED-220DC-.. rated value operating range	220V DC 154V – 242V DC
NEED-24DC-.. rated value operating range	24V DC 19.6V – 28.8V DC
NEED-12DC-.. rated value operating range	12V DC 10.2V – 14.4V DC
Rated current (for high states on all inputs and outputs) NEED-230AC-...-08-4R, NEED-230AC-22-08-4R-D NEED-220DC-...-08-4R, NEED-24DC-...-08-4R, NEED-24DC-22-08-4R-D, NEED-24DC-...-08-4T, NEED-24DC-22-08-4T-D NEED-12DC-...-08-4R, NEED-12DC-22-08-4R-D NEED-230AC-...-16-8R, NEED-230AC-22-16-8R-D NEED-220DC-...-16-8R NEED-24DC-...-16-8R, NEED-24DC-22-16-8R-D, NEED-24DC-...-16-8T, NEED-24DC-22-16-8T-D NEED-12DC-...-16-8R, NEED-12DC-22-16-8R-D	< 22mA < 14mA < 125mA < 125mA < 250mA < 44mA < 28mA < 210mA < 210mA < 420mA
Max. power consumption: NEED-230AC-...-08-4R NEED-230AC-22-08-4R-D NEED-220DC-...-08-4R NEED-24DC-...-08-4R, NEED-24DC-22-08-4R-D NEED-24DC-11-08-4T, NEED-24DC-22-08-4T-D NEED-12DC-...-08-4R , NEED-12DC-22-08-4R-D NEED-230AC-...-16-8R, NEED-230AC-22-16-8R-D NEED-220DC-...-16-8R NEED-24DC-...-16-8R, NEED-24DC-22-16-8R-D NEED-24DC-11-16-8T, NEED-24DC-22-16-8T-D NEED-12DC-...-16-8R, NEED-12DC-22-16-8R-D	< 5VA < 8VA < 3W < 3W < 3W < 3W < 10VA < 6W < 5W < 5W < 5W

Higher harmonics in the power supply signal NEED-230AC-..	< 10% of the voltage value of the fundamental component
Current protection in the power supply circuit NEED-24DC-..., NEED-12DC-..	500mA Protection against change of polarity
Current protection in the power supply circuit NEED-230AC-..., NEED-220DC-..	600mA
Resistance to slow and fast power supply voltage change	PN-EN 61131-2
Power stoppages (EN 61131-2)	20ms
Real time clock maintenance	64h in T=+25°C 24h in T=+55°C

Specification of input circuits

Digital inputs type (EN 61131-2)	Type 1 (current receiving inputs)
Quantity NEED-...-08-4	8 (I1-I8)
NEED-...-16-8	16 (I1-I16)
Visualization of logical status	LED diodes
Rated voltage: NEED-230AC-...-08-4 for the logical state of '1' for the logical state of '0'	85V – 260V 0V – 40V
NEED-230AC-...-16-8 for the logical state of '1' for the logical state of '0'	85V – 260V 0V – 32V
NEED-220DC-.. for the logical state of '1' for the logical state of '0'	80V – 260V 0V – 40V
NEED-24DC-.. for the logical state of '1' for the logical state of '0'	15 – 40V -3V – 5V
NEED-12DC-.. for the logical state of '1' for the logical state of '0'	8V – 26V -1.5V – 4V
Input current for the logical state of '1', at rated voltage: NEED-230AC-...-08-4	0.6mA (I1 – I4) 8.0mA (I5 – I6) 0.9mA (I7 – I8)
NEED-220DC-...-08-4	0,6mA (I1 – I6) 1,1mA (I7 – I8)

NEED-24DC-...-08-4	3.3mA (I1 – I6) 2.0mA (I7 – I8)
NEED-12DC-...-08-4	3.3mA (I1 – I6) 1.1mA (I7 – I8)
NEED-230AC-...-16-8	0.6mA (I1 – I11) 8.0mA (I12 – I13) 1.5mA (I14 – I16)
NEED-220DC-...-16-8	0,6mA (I1 – I13) 1,1mA (I14 – I16)
NEED-24DC-...-16-8	3.3mA (I1 – I13) 2.0mA (I14 – I16)
NEED-12DC-...-16-8	3.3mA (I1 – I13) 1.1mA (I14 – I16)
Input impedance:	
NEED-230AC-...-08-4 I1 – I4 I5 – I6 I7 – I8	400k Ω 28.75k Ω 200k Ω for the positive half-wave 400k Ω for the negative half-wave
NEED-230AC-...-16-8 I1 – I11 I12 – I13 I14 – I16	400k Ω 28.75k Ω 200k Ω for the negative half-wave 400k Ω for the negative half-wave
NEED-220DC-...-08-4 I1 – I6 I7 – I8	400k Ω 200k Ω
NEED-220DC-...-16-8 I1 – I13 I14 – I16	400k Ω 200k Ω
NEED-24DC-...-08-4 I1 – I6 I7, I8	7,44k Ω 12,36k Ω
NEED-24DC-...-16-8 I1 – I13 I14 – I16	7,44k Ω 12,36k Ω
NEED-12DC-...-08-4 I1 – I6 I7, I8	3,65k Ω 10,92k Ω
NEED-12DC-...-16-8 I1 – I13 I14 – I16	3,65k Ω 10,92k Ω

NEED-24DC-...-16-8, NEED-12DC-...-16-8 I14 – I16 in the current range	49Ω
Maximum delay time for transition from the logical state of '0' to '1': NEED-230AC-.. Contact rebound elimination ON Contact rebound elimination OFF	60ms 20ms
NEED-220DC-..., NEED-24DC-..., NEED-12-.. Contact rebound elimination ON Contact rebound elimination OFF	21ms 0.20ms + program cycle time
Maximum delay time for transition from the logical state of '1' to '0': NEED-230AC-.. Contact rebound elimination ON Contact rebound elimination OFF	60ms 20ms
NEED-220DC-..., NEED-24DC-..., NEED-12DC-.. Contact rebound elimination ON Contact rebound elimination OFF	21ms 0.25ms + program cycle time
Rated insulation resistance	300V AC
Galvanic separation: from power supply voltage mutual from outputs	no no yes
Maximum allowed lead length (the L and signal leads run together): NEED-230AC-...-08-4: for digital inputs I1 – I4 for digital inputs I5 – I6 for digital inputs I7 – I8 NEED-230AC-...-16-8: for digital inputs I1 – I11 for digital inputs I12 – I13 for digital inputs I14 – I16 NEED-220DC-.. NEED-24DC-..., NEED-12DC-..	10m 100m 10m 10m 100m 10m 10m 100m

Output circuits specification

Digital outputs type (EN 61131-2)	Relay type – NO contacts, w/o protection (AC digital outputs supplying a current) Transistor type – NO, DC digital outputs supplying a current)
Quantity NEED-..-08-4	4
NEED-..-16-8	8
Short circuit protection	NEED-..-T
Thermal switching	NEED-..-T
Visualization of logical status	LED diodes
Parallel connection of outputs for improving load capacity	not allowed
External protection of the output circuit NEED-..-R	16A (recommended installation switch B16)
Rated load current NEED-..-R NEED-..-T	10A AC in AC1 category 0,5A DC
Rated load voltage NEED-..-R NEED-..-T	250V AC in AC1 category 24V DC
Minimum contact current NEED-..-R NEED-..-T	10mA 1mA
Max. leakage current (low level on outputs) NEED-..-T	< 0,1mA
Max. voltage on outputs NEED-..-T	30V DC
Max. drop voltage on output (0,5A/24DC) NEED-..-T	< 2,5V
Minimum contact voltage NEED-..-R	10V
Contact resistance NEED-..-R	<100mΩ
Resistance of open canal NEED-..-T	< 1 Ohm
Total output current (EN 61131-2) NEED-..-08-4R NEED-..-16-8R NEED-..-08-4T NEED-..-16-8T	40A (4x10A) 80A (8x10A) 2A (4x0,5A) 4A (8x0,5A)
Rated insulation resistance reinforced basic NEED-..-R	300V between inputs and outputs between outputs
Contact gap test voltage NEED-..-R	1 000V AC
Operating time NEED-..-R	7ms
Recovery time NEED-..-R	3ms

Max. connection frequency NEED-...-R at rated load (AC1 category)	600 cycles/h
with/out load	72,000 cycles/h
Contact life NEED-...-R in AC1 category depending on the T time constant (L/R=40ms)	>0.7×10 ⁵ (10A 250V AC) >10 ⁵ (0,15A 220V DC)
Mechanical life NEED-...-R	3×10 ⁷ connection cycles
Galvanic separation: from supply voltage from digital inputs PC connector and the memory card	yes yes yes

Specification of analog input circuits

Input type	Analog inputs
Quantity: NEED-...-08-4	2 (I7 – I8)
NEED-...-16-8	3 (I14 – I16)
Input type NEED-230AC-... NEED-220DC-...-08-..., NEED-24DC-...-08-..., NEED-12DC-...-08-.. NEED-24DC-...-16-..., NEED-12DC-x1-16-..	voltage, alternating signal voltage, fixed signal voltage/current, fixed signal
Input impedance: NEED-230AC-...-08-4 I7 – I8 NEED-230AC-...-16-8 I14 – I16 NEED-220DC-...-08-4 I7 – I8 NEED-220DC-...-16-8 I14 – I16 NEED-24DC-...-08-4 I7 – I8 NEED-24DC-...-16-8 I14 – I16 NEED-12DC-...-08-4 I7 – I8 NEED-12DC-...-16-8 I14 – I16 NEED-24DC-...-16-8, NEED-12DC-...-16-8	 200kΩ for the positive half-wave 400kΩ for the negative half-wave 200kΩ for the negative half-wave 400kΩ for the negative half-wave 200kΩ 200kΩ 12,36kΩ 12,36kΩ 10,92kΩ 10,92kΩ

I14 – I16 in the current range	49Ω
Range of input signals: NEED-230AC-.. NEED-220DC-.. NEED-12DC-x1-.., NEED-24DC-x1-.. NEED-12DC-22-.., NEED-24DC-22-.. NEED-24DC-...-16-8 (current range) NEED-12DC-...-16-8 (current range)	0V - 255V AC 0V - 255V DC 0V - 25,5 DC 0V - 25,5/0 – 12,75 V DC 0 – 51/25,5 mA DC 0 – 51/25,5 mA DC
Input current at rated voltage NEED-230AC-x..08-4 NEED-220DC-...08-4 NEED-24DC-...08-4 NEED-12DC-...08-4 NEED-230AC-x1-16-8 NEED-220DC-x1-16-8 NEED-24DC-x1-16-8 NEED-12DC-x1-16-8	0.9mA 1,1mA 2.0mA 1.1mA 1.5mA 1,1mA 2.0mA 1.1mA
Conversion time	1ms
Digital resolution: NEED-230AC-.. NEED-220DC-.. NEED-12DC-x1-08-4 NEED-12DC-22-08-4, NEED-12DC-...-16-8 NEED-24DC-x1-08-4 NEED-24DC-22-08-4, NEED-24DC-...-16-8 NEED-12DC-...-16-8 (current range) NEED-24DC-...-16-8 (current range)	1V 1V 0,1V 0,1/0,05V 0,1V 0,1/0,05V 0,2/0,1mA 0,2/0,1mA
Maximum allowed sustained overload: NEED-230AC-.. NEED-220DC-.. NEED-24DC-.. NEED-12DC-..	300V AC 300V DC 40V DC 26V DC
Analog input error: Maximum error in 25°C NEED-230AC-.. NEED-220DC-.. NEED-24DC-.., NEED-12DC-..	±3% of the measuring range ±2% of the measuring range ±2% of the measuring range
Crosstalk between channels	36dB
Nonlinearity	±3%
Lead length (shielded)	40m
Galvanic separation: from power supply voltage from digital inputs from digital inputs from the programming connector	no no yes no

Central unit and memory

User program memory capacity NEED-...08-4	862 bytes
NEED-...16-8	835 bytes
Type of memory available	EEPROM
Programming languages (EN 61131-3)	Text (STL) Graphical (LAD)

<p>Program resources NEED...x1-08-4: Markers Timers Timer Accuracy Counters (counting up/down) Counted values Comparators Number of possible comparison operations Weekly clock Real time clock, Real time clock accuracy</p> <p>NEED...x1-16-8: Markers Timers Timer Accuracy Counters (counting up/down) Counted values Comparators Number of possible comparison operations Weekly clock Real time clock, Real time clock accuracy</p> <p>NEED...-22-.. Markers Text Markers Timers Timer Accuracy Counters (counting up/down) Counted values Fast Counter (up 20kHz) Comparators Number of possible comparison operations Weekly clock Real Time Clock (automatic change of summer/winter time in different time zones) Real time clock accuracy</p> <p>Additional resources for NEED-230AC...-16-8: Detection of correct direction of connection of the L1, L2, L3 phases</p> <p>Measurement of asymmetry of the L1, L2, L3 phases.</p>	<p>M1-M16 T1-T8 $\pm 1\%$ of the set value + (0 - 10)ms C1-C8 0-65535 A1-A8 10 (H1 -H4)×4 channels 1 ± 3 s/day</p> <p>M1-M16 T1-T16 $\pm 1\%$ of the set value + (0 - 10)ms C1-C8 0-65535 A1-A12 22 (H1-H4)×4 channels 1 ± 3 s/day</p> <p>M1 - M64 MT1 - MT8 T1 - T32 $\pm 1\%$ of the set value + (0 - 10)ms C1 - C8 0-65535 HC1 A1 - A16 22 (H1 - H4)×4 channels 1 ± 3 s/dzień</p> <p>MDIR</p> <p>ASYM</p>
------------------------------------------------------------------------------------------------------------------------------------------------------------------------------------------------------------------------------------------------------------------------------------------------------------------------------------------------------------------------------------------------------------------------------------------------------------------------------------------------------------------------------------------------------------------------------------------------------------------------------------------------------------------------------------------------------------------------------------------------------------------------------------------------------------------------------------------------------------------------------------------------------------------------------------------------------------------------------------------------------------------------------------------------------------------------------------------	----------------------------------------------------------------------------------------------------------------------------------------------------------------------------------------------------------------------------------------------------------------------------------------------------------------------------------------------------------------------------------------------------------------------------------------------------------------------------------------------------------------------------------------------------------------------------------------------------------------

Remanence: Clock upkeep time	64h (in 25°C) 24h (in 40C°)
Markers	M1 – M16
Counters	C5 – C8
Timers	T5 – T8

External memory card

Connector description NEED-M-1K (type A connector) 1KB	Two-row connector
NEED-M-1KB (B type connector) 1KB	One-row connector
NEED-M-4KB (B type connector) 4KB	One-row connector
Dimensions (length × height × depth)	30mm x 11mm x 5mm
Weight	2g
Memory type	EEPROM
Memory capacity	1KB
Connector interface type	I ² C

Dedicated cable

Connector description NEED-PC-15A (type A connector)	Two-row connector
NEED-PC-15B (type B connector)	One-row connector
NEED-PC-15C (type B connector)	One-row connector
Cable length	2m
Weight	100g
Connection method: with the PC: NEED-PC-15A/15B NEED-PC-15C with the relay	9 pin D-Sub USB dedicated port
Cable type: NEED-PC-15A/15B NEED-PC-15C	RS 232 USB
Digital data transmission speed NEED-PC-15A/15B NEED-PC-15C	19200bit/s 1,5Mbit/s
Data validation	checksums

13. GLOSSARY

Cycle time	– processing time of all program instructions
Password	– protection against copying of the program present in the controller memory
Memory card	– external memory of the programmable relay from which the program can be transferred to the internal memory of the relay
Compilation	– checking of the program correctness and generation of a code comprehensible to the programmable relay processor
Configuration	– setting of appropriate parameter values for the programmable relay
LAD	– graphic language for relay programming
Counter	– logical element of internal relay resources, used in the control counting functions of the program
Program loading	– writing the compiled program from the PC to the programmable relay memory
Program memory	– storage area of the relay dedicated for writing the control program by the user
Program	– record of a specified control process using a suitable programming language
Programmable relay	– relay equipped with inputs (contacts), outputs (coils) and programmable logical resources incl. memory
RUN	– one of the relay operating modes in which the program is normally processed
STL	– text relay programming language
STOP	– one of the relay operating modes in which the program is not executed by the relay – relay outputs are cut off
Timer	– logical element of the relay internal resources used in program for performance of time control functions
Trigger	– input actuating the time measurement by the Timers
Input	– physical relay input for connecting external signals coming from sensors, contacts etc.
Analogue input	– physical relay input for connecting analogue signals
Output	– physical relay output for connecting controlled devices: lamps, contactors, solenoid valves etc.
Remanent resources	– logical elements of the relay which „remember“ their state after power off

- Clock** – logical element of the relay internal resources used in program for performance of control functions utilizing real time
- Marker** – logical element of the relay internal resources used in program for performance of control function

14. INDEX

- =, statement, 93
- AND -A, 82
- AND NOT -AN, 85
- AND NOT(-AN(, 85
- AND(-A(, 82
- ASYM, 68
- Bolt fixing, 16
- CD, Counter instruction, 101
- Clock instructions, 105
- Clocks, 52
- CLR, instruction, 116
- Comparator, comparisons, 67
- Configuration, Clock, 54
- Connection, analogue inputs, 24, 26
- Connection, digital inputs, 18, 21, 22
- Connection, inputs, 27
- Connection, outputs, 30
- Connection, power supply, 31, 32, 33
- Counters, 50
- Counters, inputs, 50
- Counters, number of pulses to be counted, 50
- Counters, output, 50
- CU, Counter instruction, 100
- Editor, LAD, 148
- Examples, applications, 235
- External memory, 187
- files, types, 160
- Fixing to the DIN mounting rail, 15
- FP, statement, 94
- Input delay, 183
- Installation, 132
- Instructions for analogue inputs, 106
- LAD, 117
- LAD, Counters, 125
- LAD, inputs, 118, 122
- LAD, network, 119
- LAD, outputs, 118, 123
- LAD, program, 119
- LAD, rules, 127
- LAD, Timers, 124
- LOAD – L, 107
- Markers, 42
- MDIR marker, 43
- Memory Programming, 188
- Memory, copying, 190
- Memory, partitions, 188
- Menu, 139
- Menu, description, 140
- operation, CD Counter, 51
- Operation, Clock, 53
- Operation, CU Counter, 51
- Operation, SD Timer, 95
- Operation, SD Timer, 47
- Operation, SE Timer, 48
- Operation, SF Timer, 96
- Operation, SF Timer, 48
- Operation, SL Timer, 49
- Operation, Timer SE, 97
- Operation, Timer SL, 98
- OR NOT(-ON(, 89
- OR -O, 86
- OR(-O(, 87
- Output delay, 186
- PC connection, 132
- Potentiometer, 72
- Power supply, 178
- Preview of variables, 168
- Program cycle, 34
- Project, 133
- Real time clock, 66
- Relay resources, 36
- Remanences, 73
- Reset -R, 93
- S, statement, 93
- SE, Timer instruction, 97
- SET, instruction, 115
- Settings, 160
- Settings, Clocks, 163
- Settings, Comparators, 164
- Settings, Counters, 163
- Settings, input delays, 165
- Settings, Inputs delay, 166
- Settings, Remanences, 164
- Settings, Timers, 162
- SF, Timer instruction, 96
- SL, Timer instruction, 98, 99
- Start-up, 177
- STL, 78
- Symbols, Comparator, 67
- Symbols, digital control outputs, 41
- Symbols, digital inputs, 39
- Symbols, digital pulse outputs, 40
- Symbols, digital resetting outputs, 41
- Symbols, digital setting outputs, 41
- Symbols, inverted digital control outputs, 42
- Symbols, LAD, 117, 120
- Symbols, Markers, 42
- Symbols, normal digital outputs, 40
- Symbols, SD Timer – delayed activation, 47
- Symbols, SE Timer – Single pulse, 48
- Symbols, SF Timer – Delayed activation, 48
- Symbols, SL Timer - Pulses, 49

Terminals, cables - types, 17
Timer, inputs, 46
Timer, outputs, 47
Timer, time ranges, 46
Timer, time to be measured, 46
Timers, 46
Tools, 139
Type, designation, 10
Uninstalling, 132
XOR NOT -*XN*, 91
XOR NOT(-*XN*(, 92
XOR -*X*, 90
XOR(-*X*(, 90